



# API

Flanged Safety Relief Valves  
Series 526

# CATALOG

**LESER**

The-Safety-Valve.com

LESER Safety Valves for every industrial application



# API

**Series 526**  
Type 526



**High Performance**



**Compact Performance**



**High Efficiency**



**Clean Service**



**Critical Service**



**Modulate Action**



**Best Availability**



Chapter/Page		Chapter/Page	
<b>General</b> 00/01		<b>Type 526</b>	
Applications, General design features	00/02	Flange facings	01/76
Valve finder	00/03	Spare parts	01/77
How to use: Signs and symbols, Flange drillings and facings	00/05	Available options	01/86
How to use: Selection charts	00/06	Approvals	01/87
How to use: Capacity sheets	00/07	<b>Capacities</b>	
LEO <sub>S/G</sub>	00/09	• Steam [Metric Units + US Units]	01/88
LEO <sub>L</sub>	00/10	• Air [Metric Units + US Units]	01/90
Sour gas service	00/11	• Water [Metric Units + US Units]	01/92
		Determination of coefficient of discharge $K_{dr}/\alpha_w$	01/94
<b>Type 526</b> 01/01		<b>Options</b> 99/01	
<b>Materials</b>		Caps and levers	99/02
• Conventional design	01/02	Caps and levers – bolted	99/04
• Balanced bellows design	01/04	Metal seat	99/06
<b>How to Order</b>		Soft seal disc	99/08
• Example for numbering system	01/06	Soft seal selection	99/10
• Article numbers – Overview	01/08	Balanced bellows, Bug screen	99/12
<b>Dimensions</b>		High temperature equipment	99/15
• Metric Units	01/10	INCONEL X-750 spring	99/16
• US Units	01/12	O-ring damper	99/16
<b>Weights</b>		Lift indicator	99/17
• Metric Units	01/14	Heating jacket	99/18
• US Units	01/15		
<b>Orifice D – T</b>			
• Selection chart	01/16		
• Article numbers, dimensions and weights	01/17		
• Pressure temperature ratings	01/18		
Flange drillings	01/72		
Outlet with flange rating class 300 – Overview	01/74		

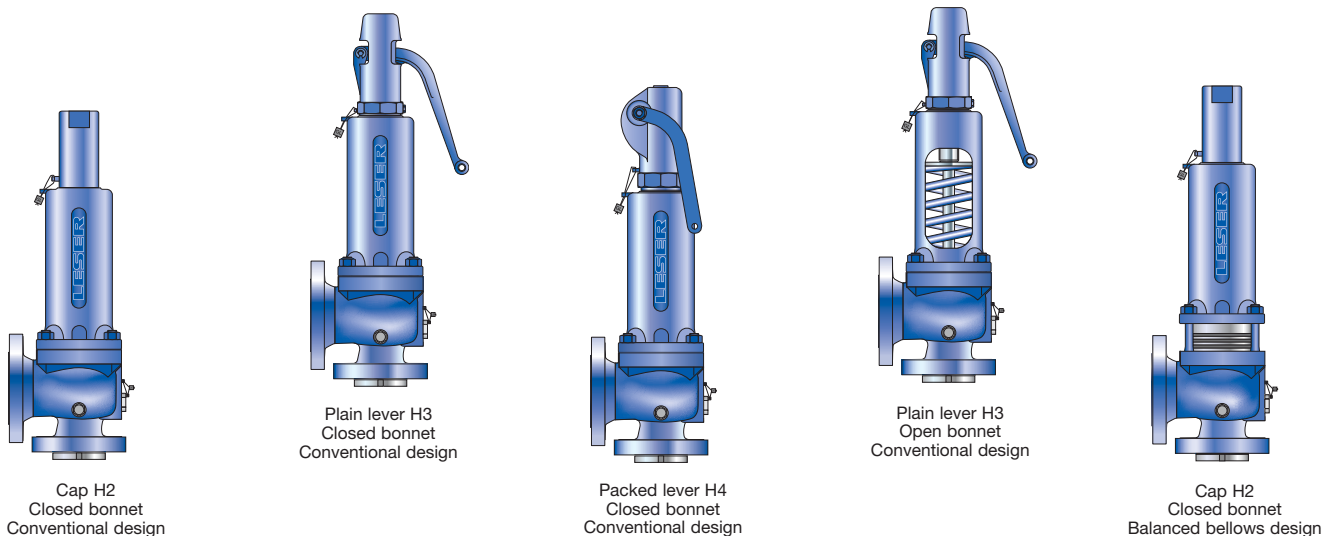





## LESER – API Safety Valves

The API product group represents

- ✓ Full range of spring loaded safety valves acc. to API 526
- ✓ State-of-the-art design from the safety valve specialist
- ✓ Competitive solutions for the API market

### LESER's API safety valves

- Are designed to meet all applications which require API.
- Open rapidly with an overpressure of max. 10 % to the full design lift.
- Have a maximum blowdown of 7 % for steam/gas service and 20 % for liquid service.
- Are developed in a close cooperation with plant engineers and service specialists.
- Serve for protection of processes and equipment.
- Are approved by all important approval organisations worldwide which ensures the worldwide applicability e.g.:
  - European Community: CE-marking acc. to Pressure Equipment Directive (PED) 97 / 23 / EC and EN ISO 4126-1
  - USA: UV-stamp acc. to ASME Section VIII Division 1, National Board certified capacities
  - Germany: VdTÜV approval acc. to PED, EN ISO 4126-1, TÜV SV 100 and AD 2000-Merkblatt A2
  - Canada: Canadian Registration Number acc. to the requirements of particular provinces
  - China: AQSIQ based on the approval acc. to ASME Section VIII Division 1 and AD 2000-Merkblatt A2

Furthermore, all LESER API safety valves are designed, marked, produced and approved acc. to the requirements of the following regulations (directives, codes, rules and standards).

EN ISO 4126-7, EN 12266-1/-2, EN 1092 Part I and II flanging  
 ASME PTC 25, ASME-Code Sec. II, ASME B 16.34 and ASME B16.5- flanging, API Std. 527, API RP 576  
 AD 2000-Merkblatt A4, AD 2000-Merkblatt HP0, TRD 110, TRD 421, TRD 721





## Applications

### LESER – API Safety Valves

offer ultimate protection against overpressures in all applications for steam, gases and liquids.

### LESER's API Series 526

Safety valves present the simple safe solution for heavy duty applications, such as crude oil extraction, transportation and processing in

- Refineries
- Chemical industry
- Petrochemical industry
- Oil and gas – Onshore and Offshore
- Vessels and piping systems
- Blow-down systems
- Storage tank farms

## General Design Features

### LESER's API Safety Valves

cover a large variety of types, materials and options to fit any application:

- Design fully in accordance with API 526 for easy interchangeability
- Complete API 526 range: valve sizes 1" through 8", orifice D through T
- Materials: WCB, WCC, CF8M, WC6, LCB, LCC, and a wide range of special materials to fulfill the requirements of critical applications
- Special B<sup>3</sup> design for high back pressure applications and material requirements far beyond API Standard
- Fool proof design with fewer parts for built-in safety
- Integral cast support brackets for easy handling and safe installation
- Open or closed bonnet, packed or plain lifting lever or gastight cap
- Flanged connections according ASME and DIN guarantee a worldwide applicability
- One design and spring (single trim) for steam, gas and liquid applications reduces the number of spare parts and ensures low cost maintenance management.
- One-piece spindle reduces friction which leads to high operation accuracy
- Self-draining body design, avoids residues and reduces corrosion
- Horizontal installation

### LESER's API Safety Valves

can be customized with a great variety of options, e.g.:

- Special connections specified by the customer for optimised adaptation to the plant.
- Stellite or hardened metal sealing for longer product life
- Soft seat solutions for superior tightness
- Balanced bellows for back pressure compensation
- Heating jackets for applications with high viscosity fluids
- Any and every part can be produced in special material exactly to meet customer specification requirements

## How to find the right Product Group

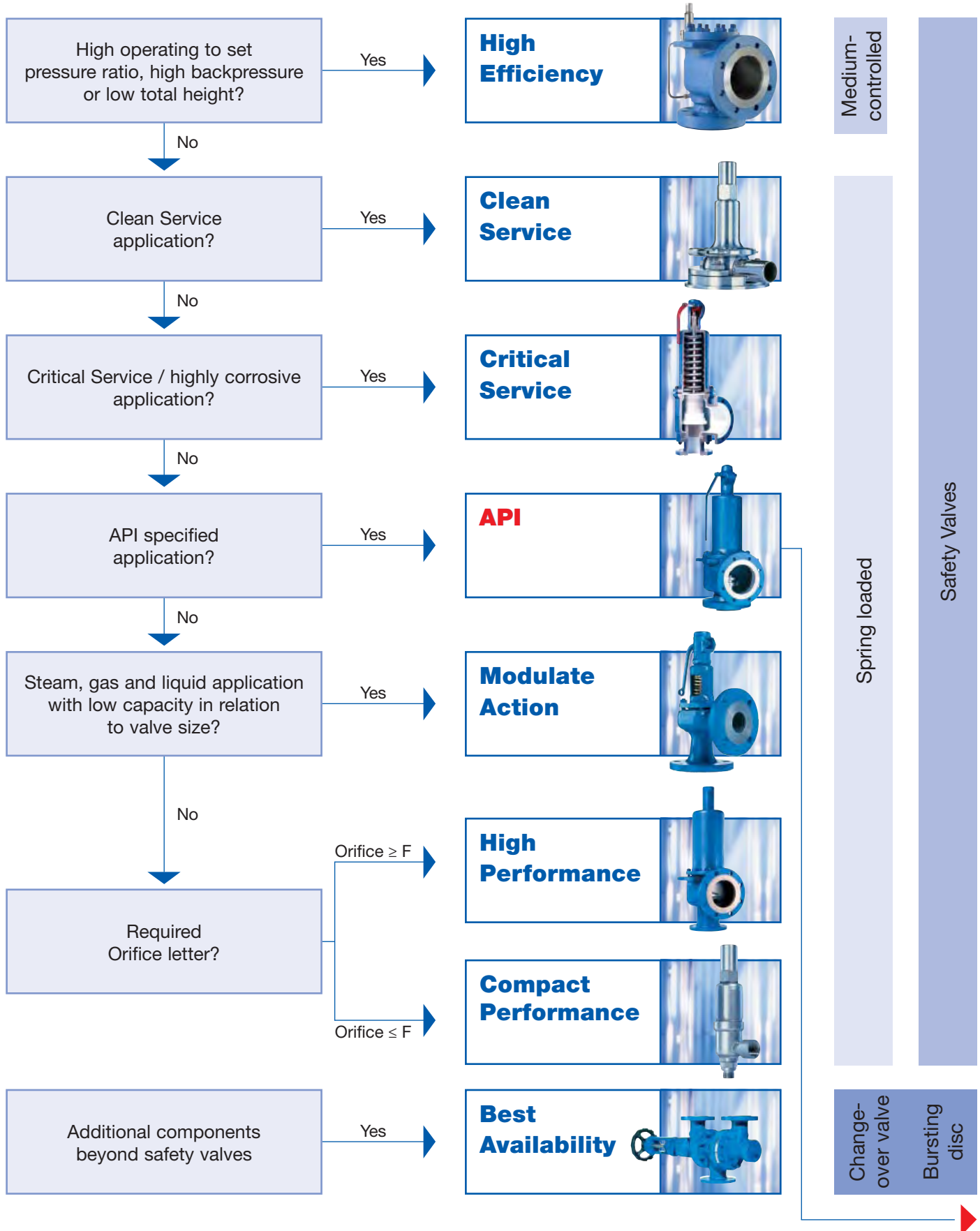

## How to find the right API Safety Valve

Step	Procedere	Reference																																																																																			
<b>6</b>	LESER Type 526																																																																																				
<b>5</b>	Determination of the code for lifting device	 <table border="1"> <thead> <tr> <th colspan="5">Code for lifting device</th> </tr> <tr> <th>Lifting device</th> <th>H2</th> <th>H3</th> <th>H4</th> <th>H3</th> </tr> </thead> <tbody> <tr> <td>Bonnet</td> <td>closed</td> <td>closed</td> <td>closed</td> <td>open</td> </tr> <tr> <td>WCB 1.0619, WC6 1.7357, LCB</td> <td>2</td> <td>3</td> <td>4</td> <td>5</td> </tr> <tr> <td>CF8M 1.4408</td> <td>2</td> <td>-</td> <td>4</td> <td>-</td> </tr> </tbody> </table>	Code for lifting device					Lifting device	H2	H3	H4	H3	Bonnet	closed	closed	closed	open	WCB 1.0619, WC6 1.7357, LCB	2	3	4	5	CF8M 1.4408	2	-	4	-																																																										
Code for lifting device																																																																																					
Lifting device	H2	H3	H4	H3																																																																																	
Bonnet	closed	closed	closed	open																																																																																	
WCB 1.0619, WC6 1.7357, LCB	2	3	4	5																																																																																	
CF8M 1.4408	2	-	4	-																																																																																	
<b>4</b>	Determination of: <ul style="list-style-type: none"> <li>Flange rating class</li> <li>Article No.</li> </ul>	<table border="1"> <thead> <tr> <th colspan="2">Selection chart</th> <th colspan="2">Specification table</th> </tr> </thead> <tbody> <tr> <td colspan="2"> </td> <td colspan="2"> <table border="1"> <thead> <tr> <th colspan="4">Article numbers, dimensions and weights</th> </tr> <tr> <th colspan="4">Article numbers</th> </tr> <tr> <th>Valve size</th> <th>1 D 2</th> <th>1 D 2</th> <th>1 D 2</th> </tr> <tr> <td>Flange rating class (ANSI / Class)</td> <td>150 x 150</td> <td>300L x 150</td> <td>300 x 150</td> </tr> <tr> <td>Actual Orifice diameter <math>d_o</math> [mm]</td> <td>14</td> <td>14</td> <td>14</td> </tr> <tr> <td>Actual Orifice area <math>A_o</math> [mm<sup>2</sup>]</td> <td>154</td> <td>154</td> <td>154</td> </tr> <tr> <th colspan="4">Body material</th> </tr> <tr> <td>WCB 1.0619</td> <td>Art.-No. 5262.001<sup>®</sup></td> <td>Use 1 D 2</td> <td>5262.002<sup>®</sup></td> </tr> <tr> <td>CF8M 1.4408</td> <td>Art.-No. 5264.010<sup>®</sup></td> <td>300 x 150</td> <td>5264.011<sup>®</sup></td> </tr> <tr> <td>WC6 1.7357</td> <td>Art.-No. -</td> <td>-</td> <td>5267.006<sup>®</sup></td> </tr> <tr> <td>LCB</td> <td>Art.-No. 5263.500<sup>®</sup></td> <td>-</td> <td>5263.501<sup>®</sup></td> </tr> </thead></table></td></tr></tbody> </table>	Selection chart		Specification table				<table border="1"> <thead> <tr> <th colspan="4">Article numbers, dimensions and weights</th> </tr> <tr> <th colspan="4">Article numbers</th> </tr> <tr> <th>Valve size</th> <th>1 D 2</th> <th>1 D 2</th> <th>1 D 2</th> </tr> <tr> <td>Flange rating class (ANSI / Class)</td> <td>150 x 150</td> <td>300L x 150</td> <td>300 x 150</td> </tr> <tr> <td>Actual Orifice diameter <math>d_o</math> [mm]</td> <td>14</td> <td>14</td> <td>14</td> </tr> <tr> <td>Actual Orifice area <math>A_o</math> [mm<sup>2</sup>]</td> <td>154</td> <td>154</td> <td>154</td> </tr> <tr> <th colspan="4">Body material</th> </tr> <tr> <td>WCB 1.0619</td> <td>Art.-No. 5262.001<sup>®</sup></td> <td>Use 1 D 2</td> <td>5262.002<sup>®</sup></td> </tr> <tr> <td>CF8M 1.4408</td> <td>Art.-No. 5264.010<sup>®</sup></td> <td>300 x 150</td> <td>5264.011<sup>®</sup></td> </tr> <tr> <td>WC6 1.7357</td> <td>Art.-No. -</td> <td>-</td> <td>5267.006<sup>®</sup></td> </tr> <tr> <td>LCB</td> <td>Art.-No. 5263.500<sup>®</sup></td> <td>-</td> <td>5263.501<sup>®</sup></td> </tr> </thead></table>		Article numbers, dimensions and weights				Article numbers				Valve size	1 D 2	1 D 2	1 D 2	Flange rating class (ANSI / Class)	150 x 150	300L x 150	300 x 150	Actual Orifice diameter $d_o$ [mm]	14	14	14	Actual Orifice area $A_o$ [mm <sup>2</sup> ]	154	154	154	Body material				WCB 1.0619	Art.-No. 5262.001 <sup>®</sup>	Use 1 D 2	5262.002 <sup>®</sup>	CF8M 1.4408	Art.-No. 5264.010 <sup>®</sup>	300 x 150	5264.011 <sup>®</sup>	WC6 1.7357	Art.-No. -	-	5267.006 <sup>®</sup>	LCB	Art.-No. 5263.500 <sup>®</sup>	-	5263.501 <sup>®</sup>																															
Selection chart		Specification table																																																																																			
		<table border="1"> <thead> <tr> <th colspan="4">Article numbers, dimensions and weights</th> </tr> <tr> <th colspan="4">Article numbers</th> </tr> <tr> <th>Valve size</th> <th>1 D 2</th> <th>1 D 2</th> <th>1 D 2</th> </tr> <tr> <td>Flange rating class (ANSI / Class)</td> <td>150 x 150</td> <td>300L x 150</td> <td>300 x 150</td> </tr> <tr> <td>Actual Orifice diameter <math>d_o</math> [mm]</td> <td>14</td> <td>14</td> <td>14</td> </tr> <tr> <td>Actual Orifice area <math>A_o</math> [mm<sup>2</sup>]</td> <td>154</td> <td>154</td> <td>154</td> </tr> <tr> <th colspan="4">Body material</th> </tr> <tr> <td>WCB 1.0619</td> <td>Art.-No. 5262.001<sup>®</sup></td> <td>Use 1 D 2</td> <td>5262.002<sup>®</sup></td> </tr> <tr> <td>CF8M 1.4408</td> <td>Art.-No. 5264.010<sup>®</sup></td> <td>300 x 150</td> <td>5264.011<sup>®</sup></td> </tr> <tr> <td>WC6 1.7357</td> <td>Art.-No. -</td> <td>-</td> <td>5267.006<sup>®</sup></td> </tr> <tr> <td>LCB</td> <td>Art.-No. 5263.500<sup>®</sup></td> <td>-</td> <td>5263.501<sup>®</sup></td> </tr> </thead></table>		Article numbers, dimensions and weights				Article numbers				Valve size	1 D 2	1 D 2	1 D 2	Flange rating class (ANSI / Class)	150 x 150	300L x 150	300 x 150	Actual Orifice diameter $d_o$ [mm]	14	14	14	Actual Orifice area $A_o$ [mm <sup>2</sup> ]	154	154	154	Body material				WCB 1.0619	Art.-No. 5262.001 <sup>®</sup>	Use 1 D 2	5262.002 <sup>®</sup>	CF8M 1.4408	Art.-No. 5264.010 <sup>®</sup>	300 x 150	5264.011 <sup>®</sup>	WC6 1.7357	Art.-No. -	-	5267.006 <sup>®</sup>	LCB	Art.-No. 5263.500 <sup>®</sup>	-	5263.501 <sup>®</sup>																																						
Article numbers, dimensions and weights																																																																																					
Article numbers																																																																																					
Valve size	1 D 2	1 D 2	1 D 2																																																																																		
Flange rating class (ANSI / Class)	150 x 150	300L x 150	300 x 150																																																																																		
Actual Orifice diameter $d_o$ [mm]	14	14	14																																																																																		
Actual Orifice area $A_o$ [mm <sup>2</sup> ]	154	154	154																																																																																		
Body material																																																																																					
WCB 1.0619	Art.-No. 5262.001 <sup>®</sup>	Use 1 D 2	5262.002 <sup>®</sup>																																																																																		
CF8M 1.4408	Art.-No. 5264.010 <sup>®</sup>	300 x 150	5264.011 <sup>®</sup>																																																																																		
WC6 1.7357	Art.-No. -	-	5267.006 <sup>®</sup>																																																																																		
LCB	Art.-No. 5263.500 <sup>®</sup>	-	5263.501 <sup>®</sup>																																																																																		
<b>3</b>	Determination of the material																																																																																				
<b>2</b>	Determination of the required orifice letter (sizing)  For Orifice > T see Type 441 XXL	<table border="1"> <thead> <tr> <th>API RP 520</th> <th>VALVESTAR<sup>®</sup> (Sizing software)</th> <th>Capacity table</th> </tr> </thead> <tbody> <tr> <td>                     Sizing, Selection and Installation of Pressure-Relieving Devices in Refineries                       Part I – Sizing and Selection                       API RECOMMENDED PRACTICE 520                 </td> <td> </td> <td>                     Capacities – Steam   <small>Capacities for saturated steam according to AD 2000-Merkblatt A2, based on set pressure plus 10% overpressure. Capacities at 1 bar (0.1 MPa) and below are based on 0.1 bar (1.45 psig) overpressure.</small>   <table border="1"> <thead> <tr> <th rowspan="2">Metric Units</th> <th colspan="5">AD 2000-Merkblatt A2 [kg/h]</th> </tr> <tr> <th>Orifice D</th> <th>E</th> <th>F</th> <th>G</th> <th>H</th> </tr> </thead> <tbody> <tr> <td>Act. Orifice dia. <math>d_o</math> [mm]</td> <td>14</td> <td>14</td> <td>16</td> <td>20.5</td> <td>25.3</td> </tr> <tr> <td>Act. Orifice area <math>A_o</math> [mm<sup>2</sup>]</td> <td>154</td> <td>154</td> <td>254</td> <td>338</td> <td>429</td> </tr> <tr> <td>LESER<sup>®</sup> (psig)</td> <td>0.111</td> <td>0.196</td> <td>0.304</td> <td>0.506</td> <td>0.801</td> </tr> <tr> <th colspan="6">Set pressure [psig]</th> </tr> <tr> <td>0.2</td> <td>19</td> <td>54</td> <td>89</td> <td>139</td> <td>221</td> </tr> <tr> <td>0.5</td> <td>42</td> <td>90</td> <td>149</td> <td>230</td> <td>367</td> </tr> <tr> <td>1</td> <td>71</td> <td>134</td> <td>221</td> <td>340</td> <td>546</td> </tr> <tr> <td>2</td> <td>100</td> <td>217</td> <td>359</td> <td>561</td> <td>888</td> </tr> <tr> <td>3</td> <td>149</td> <td>298</td> <td>498</td> <td>764</td> <td>1209</td> </tr> </tbody> </table> </td> </tr> <tr> <td><b>1</b></td> <td>Application data:                     <ul style="list-style-type: none"> <li>Pressure, temperature</li> <li>Capacity</li> <li>Medium</li> </ul> </td> <td> <table border="1"> <thead> <tr> <th colspan="3">Media</th> </tr> </thead> <tbody> <tr> <td></td> <td></td> <td></td> </tr> <tr> <td>Steam</td> <td>Gases</td> <td>Liquids</td> </tr> </tbody> </table> <p>LESER Type 526 offers single trim for steam, gas and liquids in one design.</p> </td> </tr> </tbody> </table>	API RP 520	VALVESTAR <sup>®</sup> (Sizing software)	Capacity table	Sizing, Selection and Installation of Pressure-Relieving Devices in Refineries  Part I – Sizing and Selection  API RECOMMENDED PRACTICE 520		Capacities – Steam  <small>Capacities for saturated steam according to AD 2000-Merkblatt A2, based on set pressure plus 10% overpressure. Capacities at 1 bar (0.1 MPa) and below are based on 0.1 bar (1.45 psig) overpressure.</small>  <table border="1"> <thead> <tr> <th rowspan="2">Metric Units</th> <th colspan="5">AD 2000-Merkblatt A2 [kg/h]</th> </tr> <tr> <th>Orifice D</th> <th>E</th> <th>F</th> <th>G</th> <th>H</th> </tr> </thead> <tbody> <tr> <td>Act. Orifice dia. <math>d_o</math> [mm]</td> <td>14</td> <td>14</td> <td>16</td> <td>20.5</td> <td>25.3</td> </tr> <tr> <td>Act. Orifice area <math>A_o</math> [mm<sup>2</sup>]</td> <td>154</td> <td>154</td> <td>254</td> <td>338</td> <td>429</td> </tr> <tr> <td>LESER<sup>®</sup> (psig)</td> <td>0.111</td> <td>0.196</td> <td>0.304</td> <td>0.506</td> <td>0.801</td> </tr> <tr> <th colspan="6">Set pressure [psig]</th> </tr> <tr> <td>0.2</td> <td>19</td> <td>54</td> <td>89</td> <td>139</td> <td>221</td> </tr> <tr> <td>0.5</td> <td>42</td> <td>90</td> <td>149</td> <td>230</td> <td>367</td> </tr> <tr> <td>1</td> <td>71</td> <td>134</td> <td>221</td> <td>340</td> <td>546</td> </tr> <tr> <td>2</td> <td>100</td> <td>217</td> <td>359</td> <td>561</td> <td>888</td> </tr> <tr> <td>3</td> <td>149</td> <td>298</td> <td>498</td> <td>764</td> <td>1209</td> </tr> </tbody> </table>	Metric Units	AD 2000-Merkblatt A2 [kg/h]					Orifice D	E	F	G	H	Act. Orifice dia. $d_o$ [mm]	14	14	16	20.5	25.3	Act. Orifice area $A_o$ [mm <sup>2</sup> ]	154	154	254	338	429	LESER <sup>®</sup> (psig)	0.111	0.196	0.304	0.506	0.801	Set pressure [psig]						0.2	19	54	89	139	221	0.5	42	90	149	230	367	1	71	134	221	340	546	2	100	217	359	561	888	3	149	298	498	764	1209	<b>1</b>	Application data: <ul style="list-style-type: none"> <li>Pressure, temperature</li> <li>Capacity</li> <li>Medium</li> </ul>	<table border="1"> <thead> <tr> <th colspan="3">Media</th> </tr> </thead> <tbody> <tr> <td></td> <td></td> <td></td> </tr> <tr> <td>Steam</td> <td>Gases</td> <td>Liquids</td> </tr> </tbody> </table> <p>LESER Type 526 offers single trim for steam, gas and liquids in one design.</p>	Media						Steam	Gases	Liquids
API RP 520	VALVESTAR <sup>®</sup> (Sizing software)	Capacity table																																																																																			
Sizing, Selection and Installation of Pressure-Relieving Devices in Refineries  Part I – Sizing and Selection  API RECOMMENDED PRACTICE 520		Capacities – Steam  <small>Capacities for saturated steam according to AD 2000-Merkblatt A2, based on set pressure plus 10% overpressure. Capacities at 1 bar (0.1 MPa) and below are based on 0.1 bar (1.45 psig) overpressure.</small>  <table border="1"> <thead> <tr> <th rowspan="2">Metric Units</th> <th colspan="5">AD 2000-Merkblatt A2 [kg/h]</th> </tr> <tr> <th>Orifice D</th> <th>E</th> <th>F</th> <th>G</th> <th>H</th> </tr> </thead> <tbody> <tr> <td>Act. Orifice dia. <math>d_o</math> [mm]</td> <td>14</td> <td>14</td> <td>16</td> <td>20.5</td> <td>25.3</td> </tr> <tr> <td>Act. Orifice area <math>A_o</math> [mm<sup>2</sup>]</td> <td>154</td> <td>154</td> <td>254</td> <td>338</td> <td>429</td> </tr> <tr> <td>LESER<sup>®</sup> (psig)</td> <td>0.111</td> <td>0.196</td> <td>0.304</td> <td>0.506</td> <td>0.801</td> </tr> <tr> <th colspan="6">Set pressure [psig]</th> </tr> <tr> <td>0.2</td> <td>19</td> <td>54</td> <td>89</td> <td>139</td> <td>221</td> </tr> <tr> <td>0.5</td> <td>42</td> <td>90</td> <td>149</td> <td>230</td> <td>367</td> </tr> <tr> <td>1</td> <td>71</td> <td>134</td> <td>221</td> <td>340</td> <td>546</td> </tr> <tr> <td>2</td> <td>100</td> <td>217</td> <td>359</td> <td>561</td> <td>888</td> </tr> <tr> <td>3</td> <td>149</td> <td>298</td> <td>498</td> <td>764</td> <td>1209</td> </tr> </tbody> </table>	Metric Units	AD 2000-Merkblatt A2 [kg/h]					Orifice D	E	F	G	H	Act. Orifice dia. $d_o$ [mm]	14	14	16	20.5	25.3	Act. Orifice area $A_o$ [mm <sup>2</sup> ]	154	154	254	338	429	LESER <sup>®</sup> (psig)	0.111	0.196	0.304	0.506	0.801	Set pressure [psig]						0.2	19	54	89	139	221	0.5	42	90	149	230	367	1	71	134	221	340	546	2	100	217	359	561	888	3	149	298	498	764	1209																		
Metric Units	AD 2000-Merkblatt A2 [kg/h]																																																																																				
	Orifice D	E	F	G	H																																																																																
Act. Orifice dia. $d_o$ [mm]	14	14	16	20.5	25.3																																																																																
Act. Orifice area $A_o$ [mm <sup>2</sup> ]	154	154	254	338	429																																																																																
LESER <sup>®</sup> (psig)	0.111	0.196	0.304	0.506	0.801																																																																																
Set pressure [psig]																																																																																					
0.2	19	54	89	139	221																																																																																
0.5	42	90	149	230	367																																																																																
1	71	134	221	340	546																																																																																
2	100	217	359	561	888																																																																																
3	149	298	498	764	1209																																																																																
<b>1</b>	Application data: <ul style="list-style-type: none"> <li>Pressure, temperature</li> <li>Capacity</li> <li>Medium</li> </ul>	<table border="1"> <thead> <tr> <th colspan="3">Media</th> </tr> </thead> <tbody> <tr> <td></td> <td></td> <td></td> </tr> <tr> <td>Steam</td> <td>Gases</td> <td>Liquids</td> </tr> </tbody> </table> <p>LESER Type 526 offers single trim for steam, gas and liquids in one design.</p>	Media						Steam	Gases	Liquids																																																																										
Media																																																																																					
Steam	Gases	Liquids																																																																																			

How to find the right API Safety Valve



## General signs and symbols

*	This option is covered by standard design
✓	Available
–	Not possible

## Signs and symbols for flange drillings and flange facings

*	Standard design, no option code required
(*)	Flange dimensions except flange thickness are in accordance with flange standard (e.g. ASME B16.5) Flange thickness is smaller (max. 2 mm), see “Multiple pressure rating”
–	Flange drilling/facing is not possible

## Option code for flange drilling and dimension, e.g. H50

<b>H50</b>	Flange drilling as specified in flange standard Outer flange diameter, flange thickness and height of flange facing may be larger, see “Dimensions”
<b>(H50)</b>	Flange dimensions except flange thickness are in accordance with standard Flange thickness is smaller (max. 2 mm), see “Multiple pressure rating”
<b>[H50]</b>	Flange drilling as specified in standard / flange thickness may be smaller Outer flange diameter is smaller than required, but complete back side facing for nut is assured

## Option code for flange facing, e.g. L36

<b>L36</b>	Flange facing as specified in flange standard (e.g. Flange facing inlet Type B2 “smooth finish”)
------------	--

## General information concerning flange drillings and flange facings

<b>Dimensions</b>	<p>Flange dimensions of LESER Type 526 exceed flange dimension as mentioned in ASME / ANSI B16.5 and DIN EN 1092. This exceedance is in accordance with API Standard 526, Section 2.4.</p> <p>Dimensions: “For some valve designs, the inlet raised face height may substantially exceed the nominal dimension specified in ASME / ANSI B16.5 (and DIN EN 1092). Consult the manufacturer for exact dimension.”</p> <p>The reason for this exceedance is:</p> <ul style="list-style-type: none"> <li>– height of nozzle placed in the inlet of valve</li> <li>– due to the outer diameter of the nozzle thread flange thickness has to be thicker than normal ASME / ANSI B16.5 and DIN EN 1092 dimension to achieve the required pressure rating</li> </ul>
<b>Multiple pressure rating</b>	The flange standard shows the same drilling, facing and outer diameter for several pressure ratings, e.g. PN 16 up to PN 40 Due to the pressure rating of the casting LESER fulfills the requirements for flange thickness e.g. of PN 16 but not PN 40
<b>Smooth finish</b>	<p>The effective MSS SP-6 (Edition 2001) does not mention “smooth finish” anymore.</p> <p>In MSS SP-6 (Edition 1980) “smooth finish” is defined for finishes of contact flanges as “250 μinch (6.3 μm) AARH max.”.</p> <p>LESER supplies flange facings according to ASME B16.5 – 1996, paragraph 6.4.4.3:</p> <p>“Either a serrated concentric or serrated spiral finish resulting in service finish from 125 μinch to 250 μinch average roughness shall be furnished.” This finish meets the requirements of MSS SP-6 (Edition 1980), which is not valid anymore!</p>
<b>Stock finish</b>	Stock finish is not defined in any technical standard. If purchase orders show “stock finish” LESER supplies standard facing according to DIN or ASME (marked with * in table “Flange facings” of each valve series).

## Materials

Please find below a summary of material codes at LESER. Please note that

- for every body material an inspection certificate 3.1 according to EN 10204 is available
- many materials have a multiple inspection certificate 3.1.

Material code	Flanged safety valve body	Body material is certified with 3.1 (EN 10204) for the following materials	
		DIN EN	ASME
xxx 2. xxxx	Carbon steel	1.0619	WCB, WCC
xxx 3. xxxx	Low temperature carbon steel	1.0619	LCB, LCC, WCB, WCC
xxx 4. xxxx	Stainless steel	1.4408	CF8M (Charpy test at -196 °C)
xxx 7. xxxx	High temperature carbon steel	1.7357	WC6

## Selection charts

The pages 01/16 – 01/71 contain selection charts and specification tables.

They specify important data about the valves based on the API 526 fifth edition 2002 like

- Valve size
- Body materials
- Flange rating classes
- Set pressure and temperature limits
- Back pressure limits

Procedure		
Step	Procedure	Reference
1	Determination of the required flow area and orifice letter (sizing)	<ul style="list-style-type: none"> <li>• API RP 520</li> <li>• VALVESTAR – Sizing software</li> <li>• Capacity tables (page 01/88 – 01/93)</li> </ul>
2	Determination of: <ul style="list-style-type: none"> <li>• Material</li> <li>• Flange rating class</li> <li>• Article No.</li> </ul>	Selection charts (page 01/16 – 01/68) or Specification tables (page 01/17 – 01/71)
3	Determination of the material	Specification tables (page 01/17 – 01/71)
4	Determination of the code for lifting device	Specification tables (page 01/17 – 01/71)

## Type 526

## Orifice D<sup>3</sup>

### Selection chart

	150 x 150	300L x 150	300 x 150	600 x 150	900 x 300	1500 x 300	2500 x 300
WCB	5262.001X	See 300 x 150	5262.002X	5262.003X	See 1500 x 300	5262.004X	5262.005X
WC6	-	See 300 x 150	5267.006X	5267.007X	See 1500 x 300	5267.008X	5267.009X

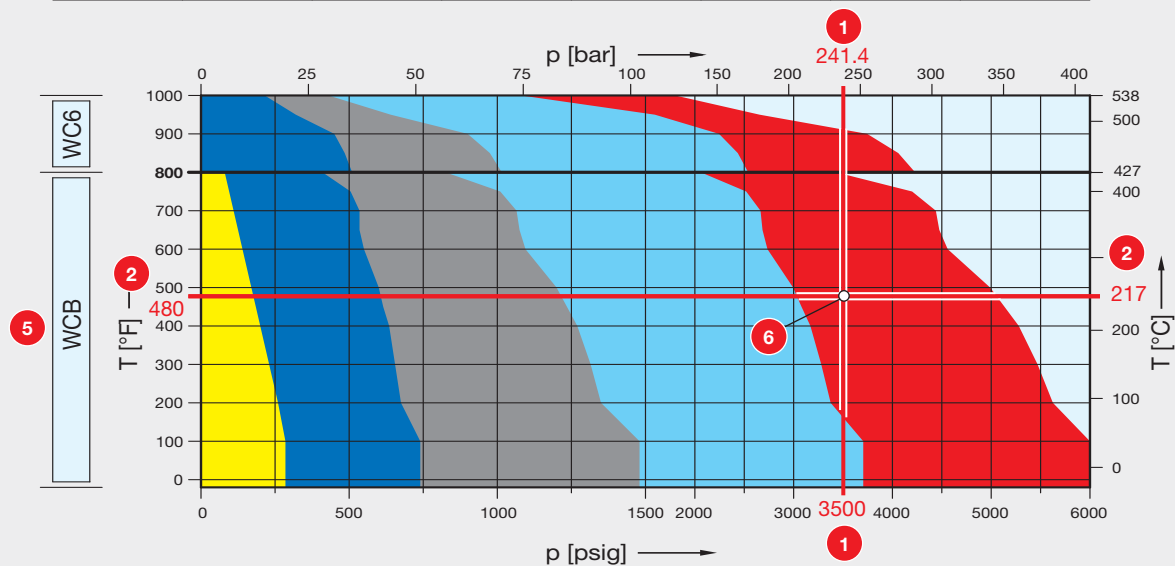

### Explanation

No.	Description	No.	Description	Example
1	Set pressure	p	241.4 bar	3500 psig
2	Temperature	T	217 °C	480 °F
3	Required orifice letter			D
4	Flange rating class			2500 x 300
5	Material			WCB 1.0619
6	Article No. (X = Code for lifting device)			5262.005X

## Sample Capacity sheet –

### How to select capacities for steam: Type 526, Valve size 1 F 2

#### Type 526 Capacities – Steam

Capacities for saturated steam according to AD 2000-Merkblatt A2, based on set pressure plus 10 % overpressure. **8**

Capacities at 1 bar (14.5 psig) and below are based on 0.1 bar (1.45 psig) overpressure.

Metric Units	AD 2000-Merkblatt A2 [kg/h]				
Orifice	D	E	F	G	H
Act. Orifice dia. $d_0$ [mm]	14	14	18	22,5	28,3
Act. Orifice area $A_0$ [mm <sup>2</sup> ]	154	154	254	398	629
LEO <sub>S/G</sub> <sup>*)</sup> [inch <sup>2</sup> ]	0.111	0.19	0.324	0.506	0.801
Set pressure [bar]	Capacities [kg/h]				
0.2	19	54	89	139	221
0.5	42	90	149	232	367
1	71	134	221	345	546
2	120	217	359	561	888
3	166	296	489	764	1209

Capacities for saturated steam according to ASME Section VIII (UV), based on set pressure plus 10% overpressure.

Capacities at 2.07 bar (30 psig) and below are based on 0.207 bar (3 psig) overpressure.

US Units	ASME Section VIII [lb/h]				
Orifice	D	E	F	G	H
Act. Orifice dia. $d_0$ [inch]	0.551	0.551	0.709	0.886	1.11
Act. Orifice area $A_0$ [inch <sup>2</sup> ]	0.239	0.239	0.394	0.616	0.975
LEO <sub>S/G</sub> <sup>*)</sup> [inch <sup>2</sup> ]	0.111	0.196	0.324	0.506	0.801
Set pressure [psig]	Capacities [lb/h]				
15	183	321	531	830	1313
20	211	371	613	957	1515
30	266	469	775	1212	1917
40	328	577	954	1491	2359
50	389	686	1133	1771	2802

<sup>\*)</sup> LEO<sub>S/G</sub> = LESER Effective Orifice steam/gas please refer to page 00/09

Explanation		Type 526, Valve size 1 F 2			
No.	Description		Metric Units	US Units	Example
<b>1</b>	Code				AD 2000-Merkblatt A2
<b>2</b>	Orifice				F
<b>3</b>	Actual orifice diameter	$d_0$	[mm]	[inch]	18
<b>4</b>	Actual orifice area	$A_0$	[mm <sup>2</sup> ]	[inch <sup>2</sup> ]	254
<b>5</b>	LESER Effective Orifice	LEO <sub>S/G</sub>	[inch <sup>2</sup> ]	[inch <sup>2</sup> ]	0.324
<b>6</b>	Set pressure		[bar <sub>g</sub> ]	[psig]	1
<b>7</b>	Capacity		[kg/h]	[lb/h]	221
<b>8</b>	Base of calculation				see table page 00/08



8

## Base of calculation

		Metric Units		US Units	
Code		Capacity calculation according to AD 2000-Merkblatt A2		Capacity calculation according to ASME Section VIII (UV)	
<b>Media</b>					
<b>STEAM</b> (saturated steam)	Standard conditions	Steam table IAPWS-IF97 IAPWS Industrial Formulation for the Thermodynamic Properties of Water and Steam	[kg/h]	Steam table IAPWS-IF97 IAPWS Industrial Formulation for the Thermodynamic Properties of Water and Steam	[lb/h]
<b>AIR</b>	Standard conditions	0 °C and 1013 mbar	[m <sup>3</sup> /h]	16 °C (60 °F)	[S.C.F.M.]
<b>WATER</b>	Standard conditions	20 °C (68 °F)	[10 <sup>3</sup> kg/h]	21 °C (70 °F)	[US-G.P.M.]
<b>All Media</b>					
	Calculation pressure	Set pressure plus 10 % overpressure		Set pressure plus 10 % overpressure	
	Calculation pressure for low set pressure	Capacities at 1 bar (14.5 psig) and below are based on 0.1 bar (1.45 psig) overpressure.		Capacities at 2.07 bar (30 psig) and below are based on 0.207 bar (3 psig) overpressure.	

## Example

### Capacity calculation pressure

Metric Units		US Units	
Set pressure	Capacity calculation pressure	Set pressure	Capacity calculation pressure
10 bar	10 bar + 10% overpressure = 11 bar	145 psig	145 psig + 10% overpressure = 159.5 psig
0.5 bar	0,5 bar + 0.1 bar overpressure = 0.6 bar	20 psig	20 psig + 3 psig overpressure = 23 psig

5

## LESER Effective Orifice

Pressure relief devices may be initially sized using the equations shown in API RP 520, sections 3.6 through 3.10 as appropriate for vapors, gases, liquids, or two phase flow. These equations utilize effective coefficient of discharge (S/G 0.975, L 0.650) and effective areas (acc. to API Std. 526, Fifth Edition, June 2002, table 1) which are independent of any

specific valve design. In this way the designer can determine a preliminary pressure relief valve size. By using the LESER Effective Orifice the designer can directly select a LESER safety relief valve after calculating the orifice letter. In this case, a verification of the sizing with the selected actual orifice and the rated coefficient of discharge is not necessary.

<b>LEO<sub>S/G</sub></b>	<b>LESER Effective Orifice (for steam, gas and vapor)</b>	<b>[inch<sup>2</sup>]</b>	refer to page 00/09
<b>LEO<sub>L</sub></b>	<b>LESER Effective Orifice (for liquid)</b>	<b>[inch<sup>2</sup>]</b>	refer to page 00/10

For further information refer to LESER ENGINEERING at [www.leser.com/engineering](http://www.leser.com/engineering)

This table is based on the rated coefficient of discharge for steams and gases of LESER safety valves certified by ASME. The appropriated K-values are shown in the column "K-value" of the table.

$$LEO_{S/G} [\text{inch}^2] = A_0 [\text{inch}^2] \cdot \left( \frac{K}{0,975} \right)$$

LEO <sub>S/G</sub>		LESER Effective Orifice (for steam, gas and vapor)						
Orifice acc. API 526	Flange rating class	Valve size	d <sub>0</sub> [inch]	d <sub>0</sub> [mm]	K-value	LEO <sub>S/G</sub> [inch <sup>2</sup> ]	% of next higher orifice	% of next lower orifice
<b>D</b>						<b>0.110</b>	<b>100.0%</b>	<b>100.0%</b>
	150 – 600	1 D 2	0.551	14.0	0.455	0.111	56.8%	101.2%
	900 – 1500	1 1/2 D 2	0.551	14.0	0.455	0.111	56.8%	101.2%
	2500	1 1/2 D 3	0.551	14.0	0.455	0.111	56.8%	101.2%
<b>E</b>						<b>0.196</b>	<b>100.0%</b>	<b>100.0%</b>
	150 – 600	1 E 2	0.551	14.0	0.801	0.196	63.9%	100.0%
	900 – 1500	1 1/2 E 2	0.551	14.0	0.801	0.196	63.9%	100.0%
	2500	1 1/2 E 3	0.551	14.0	0.801	0.196	63.9%	100.0%
<b>F</b>						<b>0.307</b>	<b>100.0%</b>	<b>100.0%</b>
	150 – 600	1 1/2 F 2	0.709	18.0	0.801	0.324	64.4%	105.5%
	900 – 2500	1 1/2 F 3	0.709	18.0	0.801	0.324	64.4%	105.5%
<b>G</b>						<b>0.503</b>	<b>100.0%</b>	<b>100.0%</b>
	150 – 900	1 1/2 G 3	0.886	22.5	0.801	0.506	64.5%	100.7%
	1500 – 2500	2 G 3	0.886	22.5	0.801	0.506	64.5%	100.7%
<b>H</b>						<b>0.785</b>	<b>100.0%</b>	<b>100.0%</b>
	150 – 300L	1 1/2 H 3	1.114	28.3	0.801	0.801	62.2%	102.0%
	300 – 1500	2 H 3	1.114	28.3	0.801	0.801	62.2%	102.0%
<b>J</b>						<b>1.287</b>	<b>100.0%</b>	<b>100.0%</b>
	150 – 300L	2 J 3	1.417	36.0	0.801	1.296	70.5%	100.7%
	300 – 1500	3 J 4	1.417	36.0	0.801	1.296	70.5%	100.7%
<b>K</b>						<b>1.838</b>	<b>100.0%</b>	<b>100.0%</b>
	150 – 600	3 K 4	1.693	43.0	0.801	1.849	64.8%	100.6%
	900 – 1500	3 K 6	1.693	43.0	0.801	1.849	64.8%	100.6%
<b>L</b>						<b>2.853</b>	<b>100.0%</b>	<b>100.0%</b>
	150 – 300L	3 L 4	2.106	53.5	0.801	2.863	79.5%	100.3%
	300 – 1500	4 L 6	2.106	53.5	0.801	2.863	79.5%	100.3%
<b>M</b>						<b>3.600</b>	<b>100.0%</b>	<b>100.0%</b>
	150 – 900	4 M 6	2.374	60.3	0.801	3.637	83.8%	101.0%
<b>N</b>						<b>4.340</b>	<b>100.0%</b>	<b>100.0%</b>
	150 – 900	4 N 6	2.598	66.0	0.801	4.357	68.3%	100.4%
<b>P</b>						<b>6.380</b>	<b>100.0%</b>	<b>100.0%</b>
	150 – 900	4 P 6	3.150	80.0	0.801	6.401	57.9%	100.3%
<b>Q</b>						<b>11.050</b>	<b>100.0%</b>	<b>100.0%</b>
	150 – 600	6 Q 8	4.154	105.5	0.801	11.132	69.6%	100.7%
<b>R</b>						<b>16.000</b>	<b>100.0%</b>	<b>100.0%</b>
	150	6 R 8	4.961	126.0	0.801	16.004	61.6%	100.0%
	300 – 600	6 R 10	4.961	126.0	0.801	16.004	61.6%	100.0%
<b>T</b>						<b>26.000</b>	<b>100.0%</b>	<b>100.0%</b>
	150 – 300	8 T 10	6.358	161.5	0.801	26.085		100.3%

This table is based on the rated coefficient of discharge for steams and gases of LESER safety valves certified by ASME. The appropriated K-values are shown in the column "K-value" of the table.

$$LEO_L [\text{inch}^2] = A_0 [\text{inch}^2] \cdot \left( \frac{K}{0,650} \right)$$

LEO <sub>L</sub>		LESER Effective Orifice (for liquid)						
Orifice acc. API 526	Flange rating class	Valve size	d <sub>0</sub> [inch]	d <sub>0</sub> [mm]	K-value	LEO <sub>L</sub> [inch <sup>2</sup> ]	% of next higher orifice	% of next lower orifice
<b>D</b>						<b>0.110</b>	<b>100.0%</b>	<b>100.0%</b>
	150 – 600	1 D 2	0.551	14.0	0.343	0.126	64.2%	114.5%
	900 – 1500	1 1/2 D 2	0.551	14.0	0.343	0.126	64.2%	114.5%
	2500	1 1/2 D 3	0.551	14.0	0.343	0.126	64.2%	114.5%
<b>E</b>						<b>0.196</b>	<b>100.0%</b>	<b>100.0%</b>
	150 – 600	1 E 2	0.551	14.0	0.579	0.213	69.2%	108.4%
	900 – 1500	1 1/2 E 2	0.551	14.0	0.579	0.213	69.2%	108.4%
	2500	1 1/2 E 3	0.551	14.0	0.579	0.213	69.2%	108.4%
<b>F</b>						<b>0.307</b>	<b>100.0%</b>	<b>100.0%</b>
	150 – 600	1 1/2 F 2	0.709	18.0	0.579	0.351	69.8%	114.4%
	900 – 2500	1 1/2 F 3	0.709	18.0	0.579	0.351	69.8%	114.4%
<b>G</b>						<b>0.503</b>	<b>100.0%</b>	<b>100.0%</b>
	150 – 900	1 1/2 G 3	0.886	22.5	0.579	0.549	69.9%	109.1%
	1500 – 2500	2 G 3	0.886	22.5	0.579	0.549	69.9%	109.1%
<b>H</b>						<b>0.785</b>	<b>100.0%</b>	<b>100.0%</b>
	150 – 300L	1 1/2 H 3	1.114	28.3	0.579	0.868	67.5%	110.6%
	300 – 1500	2 H 3	1.114	28.3	0.579	0.868	67.5%	110.6%
<b>J</b>						<b>1.287</b>	<b>100.0%</b>	<b>100.0%</b>
	150 – 300L	2 J 3	1.417	36.0	0.579	1.405	76.5%	109.2%
	300 – 1500	3 J 4	1.417	36.0	0.579	1.405	76.5%	109.2%
<b>K</b>						<b>1.838</b>	<b>100.0%</b>	<b>100.0%</b>
	150 – 600	3 K 4	1.693	43.0	0.579	2.005	70.3%	109.1%
	900 – 1500	3 K 6	1.693	43.0	0.579	2.005	70.3%	109.1%
<b>L</b>						<b>2.853</b>	<b>100.0%</b>	<b>100.0%</b>
	150 – 300L	3 L 4	2.106	53.5	0.579	3.104	86.2%	108.8%
	300 – 1500	4 L 6	2.106	53.5	0.579	3.104	86.2%	108.8%
<b>M</b>						<b>3.600</b>	<b>100.0%</b>	<b>100.0%</b>
	150 – 900	4 M 6	2.374	60.3	0.579	3.943	90.9%	109.5%
<b>N</b>						<b>4.340</b>	<b>100.0%</b>	<b>100.0%</b>
	150 – 900	4 N 6	2.598	66.0	0.579	4.724	74.0%	108.8%
<b>P</b>						<b>6.380</b>	<b>100.0%</b>	<b>100.0%</b>
	150 – 900	4 P 6	3.150	80.0	0.579	6.940	62.8%	108.8%
<b>Q</b>						<b>11.050</b>	<b>100.0%</b>	<b>100.0%</b>
	150 – 600	6 Q 8	4.154	105.5	0.579	12.070	75.4%	109.2%
<b>R</b>						<b>16.000</b>	<b>100.0%</b>	<b>100.0%</b>
	150	6 R 8	4.961	126.0	0.579	17.353	66.7%	108.5%
	300 – 600	6 R 10	4.961	126.0	0.579	17.353	66.7%	108.5%
<b>T</b>						<b>26.000</b>	<b>100.0%</b>	<b>100.0%</b>
	150 – 300	8 T 10	6.358	161.5	0.579	28.283		108.8%



## Normative basis

### NACE MR0175-2003

In accordance with NACE standard MR0175-2003 sour gas service means the presence of H<sub>2</sub>S in the following conditions:

**Section 1.4.1.1** All gas, gas condensate, and sour crude oil  
 – When the partial pressure of H<sub>2</sub>S in a wet (water as a liquid) gas phase of a gas, gas condensate, or crude oil system is equal to or exceeds 0.003 bar<sub>g</sub> (0.05 psia)

Exceptions are:

### Section 1.4.2.1 Low-pressure gas

When the total pressure is lower than 4.5 bar<sub>a</sub> (65psia)

### Section 1.4.2.2 Low-pressure oil and gas multiphase systems: ...

#### Other Sour gas standards:

**NACE MR0103-2003:** Materials resistance to sulfide stress cracking in corrosive petroleum refining environments.

**DIN EN ISO 15156-1:** Petroleum and natural gas industries  
 – Materials for use in H<sub>2</sub>S containing environments in oil and gas production – Part 1: General principles for selection of cracking-resistant materials (ISO 15156-1:2001)

**Works standard:** Please refer to LWN 001.91

## General requirements for sour gas service

The above mentioned standards require a maximum hardness of 22 HRC for the most steels. For the actual requirements of a specific material please refer to the applied standard.

## LESER sour gas level

General: Sour gas material requirements must be fulfilled if pressure and partial pressure conditions according to the applied standard exist. Based on these general statement LESER defines two sour gas level for safety valves:

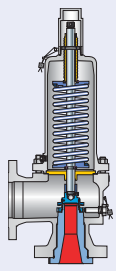
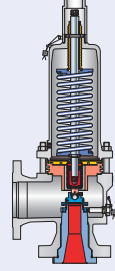
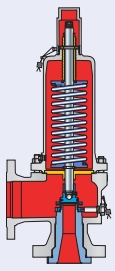
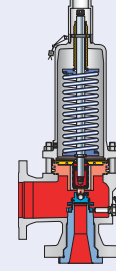
		Level 1		Level 2	
Part definition		Contact with the medium in closed position		Contact with the medium in opened position	
		Conventional	Balanced bellows	Conventional	Balanced bellows
Contact area					
Pressure requirements		Set pressure ≥ 4.5 bar <sub>a</sub> (65psia)		Back pressure ≥ 4.5 bar <sub>a</sub> (65psia)	
Safety valve operation		closed		closed / opened	
Parts concerned		Conventional design	Nozzle Disc	All	
		Balanced bellows design	Nozzle Disc	Nozzle, Disc Bonnet spacer Bellows	

## Necessary material modification

Type	Body material	Design	Part	Material	Option code	Material	Option code
5262 5263 5267	WCB 1.0619 LCB WC6 1.7357	Conventional	Disc	1.4404/316L stel.	L44	1.4404/316L stel.	L44
			Spring	No modification required		2.4669/Inconel X-750	X08
		Balanced bellows	Disc	1.4404 / 316L stellited	L44	1.4404 / 316L stellited	L44
			Bellows	2.4856/1.4404, Inconel 625/316L	J83	2.4856/1.4404, Inconel 625/316L	J83
5264	CF8M 1.4408	Conventional	Spring	No modification required		2.4669/ Inconel X-750	X08
		Balanced bellows	Bellows	2.4856/1.4404, Inconel 625/316L	J83	2.4856/1.4404, Inconel 625/316L	J83



**Type 526**  
Packed lever H4  
Closed bonnet  
Conventional design

# Type 526

## Flanged Safety Relief Valves – spring loaded

<b>Contents</b>	<b>Chapter/Page</b>
<b>Materials</b>	
• Conventional design	01/02
• Balanced bellows design	01/04
<b>How to order</b>	
• Example for numbering system	01/06
• Article numbers	01/08
<b>Dimensions</b>	
• Metric Units	01/10
• US Units	01/12
<b>Weights</b>	
• Metric Units	01/14
• US Units	01/15
<b>Orifice [D – T]</b>	
• Selection charts / Article numbers, dimensions and weights	01/16
• Pressure temperature ratings [Metric Units + US Units]	01/18
Flange drillings	01/72
Outlet with flange rating class 300	01/74
Flange facings	01/76
Spare parts	01/77
Available options	01/86
Approvals	01/87
<b>Capacities</b>	
• Steam [Metric Units + US Units]	01/88
• Air [Metric Units + US Units]	01/90
• Water [Metric Units + US Units]	01/92
Determination of coefficient of discharge $K_{dr}/\alpha_w$	01/94

## Conventional design

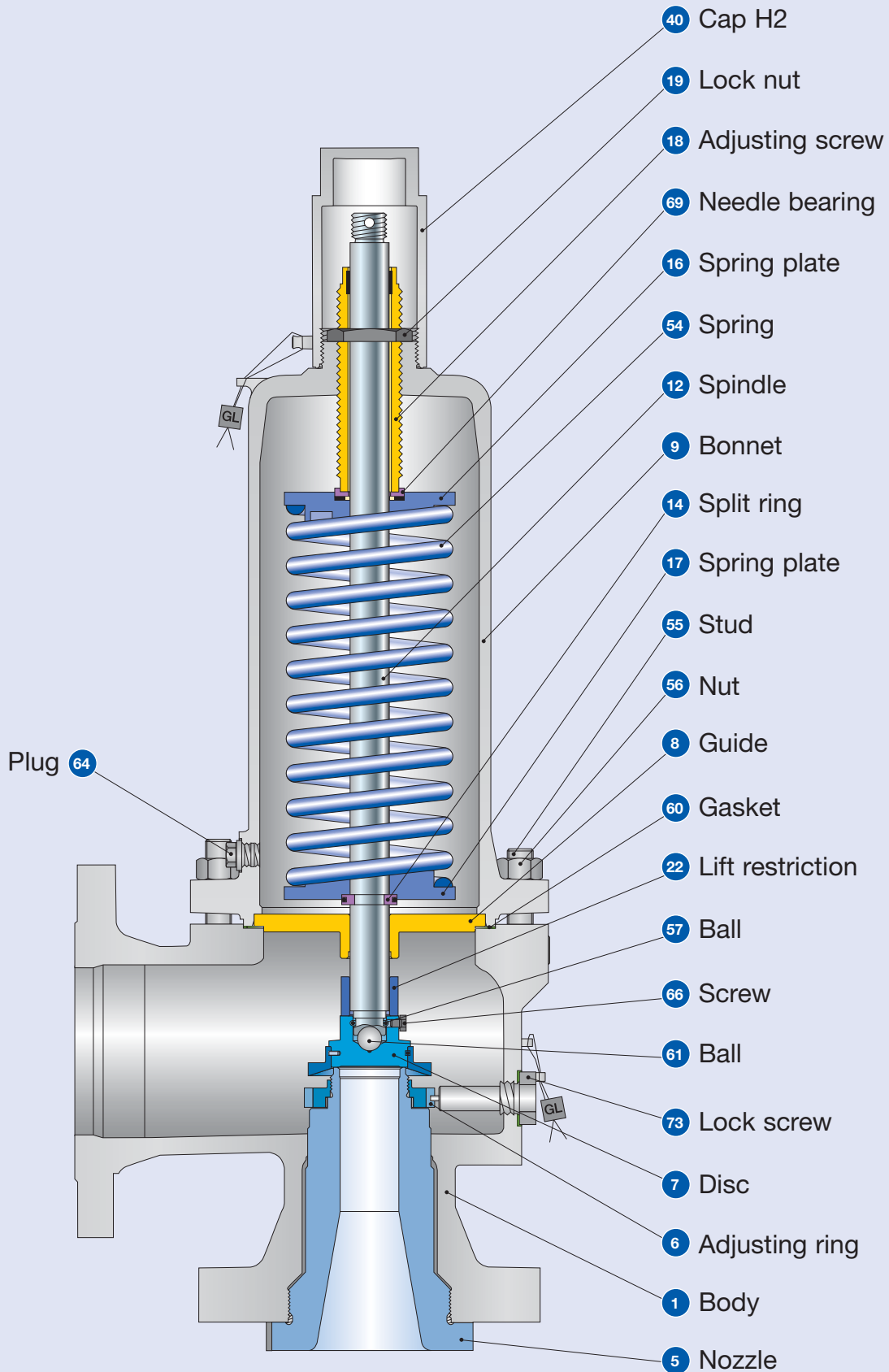

## Conventional design

Materials		Standard Service Type 5262 Trim: Standard	Corrosive Service Type 5264 Trim: Standard	Type 5267 Trim: Standard	Type 5263 Trim: Standard
1	Body	1.0619	1.4408	1.7357	
		SA 216 WCB	SA 351 CF8M	SA 217 WC6	SA 352 LCB
5	Nozzle <sup>1)</sup>	1.4408	1.4408	1.4408 stellited	1.4408
		CF8M	CF8M	CF8M stellited	CF8M
6	Adjusting ring	1.4408	1.4408	1.4408	1.4408
		CF8M	CF8M	CF8M	CF8M
7	Disc	1.4122	1.4404 stellited	1.4122	1.4122
		Hardened stainless steel	316L stellited	Hardened stainless steel	Hardened stainless steel
8	Guide with bushing	1.0501	1.4404	1.4404	1.0501
		Steel	316L	316L	Steel
		1.4104 tenifer	-	-	1.4104 tenifer
		Chrome steel tenifer	-	-	Chrome steel tenifer
9	Bonnet Valve size 6 R 10, 8 T 10	1.0619	1.4404, 1.4408, 1.4571	1.7357	
		SA 216 WCB	SA 479 316L, SA 351 CF8M, 316Ti	SA 217 WC6	SA 352 LCB
		1.0305	1.4571	1.0305	1.0305
		Steel	SA 479 316Ti	Steel	Steel
12	Spindle	1.4021	1.4021	1.4021	1.4021
		420	420	420	420
14	Split ring	1.4104	1.4404	1.4104	1.4104
		Chrome steel	316L	Chrome steel	Chrome steel
16 / 17	Spring plate	1.0718	1.4404	1.0718	1.0718
		Steel	316L	Steel	Steel
18	Adjusting screw with bushing	1.4104	1.4404 tenifer	1.4104	1.4104
		Chrome steel	316L tenifer	Chrome steel	Chrome steel
		PTFE with 15% Glas	PTFE 15% Glas	PTFE 15% Glas	PTFE 15% Glas
		PTFE with 15% Glas	PTFE with 15% Glas	PTFE with 15% Glas	PTFE with 15% Glas
19	Lock nut	1.0718	1.4404	1.0718	1.0718
		Steel	316L	Steel	Steel
22	Lift restriction	1.4404	1.4404	1.4404	1.4404
		316L	316L	316L	316L
40	Cap H2	1.0718	1.4404	1.0718	1.0718
		Steel	316L	Steel	Steel
54	Spring	1.7102, 1.8159	1.4310	1.7102, 1.8159	1.7102, 1.8159
		High temp. alloy steel	Stainless steel	High temp. alloy steel	High temp. alloy steel
55	Stud	1.4401	1.4401	1.4401	1.4401
		B8M	B8M	B8M	B8M
56	Nut	1.4401	1.4401	1.4401	1.4401
		8M	8M	8M	8M
57	Ball	1.4401	1.4401	1.4401	1.4401
		316	316	316	316
60	Gasket	Graphite / 1.4401	Graphite / 1.4401	Graphite / 1.4401	Graphite / 1.4401
		Graphite / 316	Graphite / 316	Graphite / 316	Graphite / 316
61	Ball	1.3541	1.4401	1.3541	1.3541
		Hardened stainless steel	316	Hardened stainless steel	Hardened stainless steel
64	Plug	Steel	1.4401	Steel	Steel
		Steel	B8M	Steel	Steel
66	Screw	1.4401	1.4401	1.4401	1.4401
		B8M	B8M	B8M	B8M
69	Needle bearing	1.4404	1.4404	1.4404	1.4404
		316L	316 L	316L	316L
73	Lock screw	1.4404	1.4404	1.4404	1.4404
		8M	8M	8M	8M

<sup>1)</sup> Stellited sealing surfaces please refer to page 99/06. LESER reserves also to use the nozzle material 1.4404/316L.

**Please notice:**

- Modifications reserved by LESER
- If several materials are specified LESER defines the material.
- LESER can upgrade materials without notice
- Every part can be replaced by other material acc. to customer specification.

**Special materials:**

Body and trim available in various materials (Monel®, Hastelloy® ...).  
For nozzle and disc machined from the bar a short lead time is possible.

## Balanced bellows design

Type 526

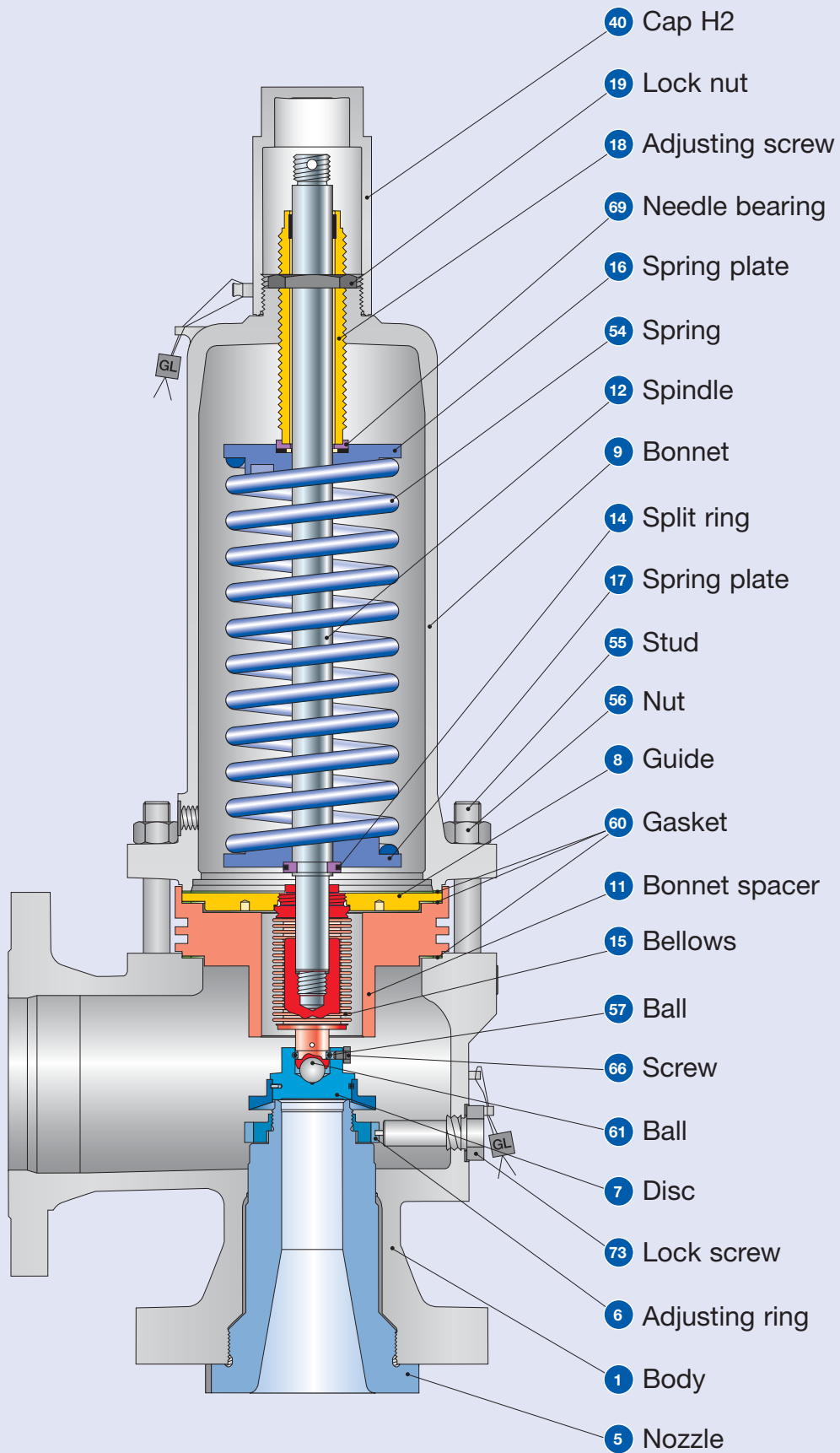



## Balanced bellows design

Materials			Standard Service Type 5262	Corrosive Service Type 5264	Type 5267	Type 5263
Item	Component		Trim: Standard	Trim: Standard	Trim: Standard	Trim: Standard
1	Body		1.0619	1.4408	1.7357	
			SA 216 WCB	SA 315 CF8M	SA 217 WC6	SA 352 LCB
5	Nozzle <sup>1)</sup>		1.4408	1.4408	1.4408 stellited	1.4408
			CF8M	CF8M	CF8M stellited	CF8M
6	Adjusting ring		1.4408	1.4408	1.4404	1.4408
			CF8M	CF8M	316L	CF8M
7	Disc		1.4122	1.4404 stellited	1.4122	1.4122
			Hardened stainless steel	316L stellited	Hardened stainless steel	Hardened stainless steel
8	Guide		1.4404	1.4404	1.4404	1.4404
			316 L	316L	316L	316L
9	Bonnet Valve size 6 R 10, 8T10		1.0619	1.4404, 1.4408, 1.4571	1.7357	
			SA 216 WCB	SA 479 316L, SA 351 CF8M, 316Ti	SA 217 WC6	SA 352 LCB
			1.0305	1.4571	1.0305	1.0305
			Steel	SA 479 316Ti	Steel	Steel
11	Bonnet spacer <sup>2)</sup>		1.0460	1.4404	1.4404	1.4404
			Carbon steel	SA 479 316L	SA 479 316L	316L
12	Spindle		1.4021	1.4021	1.4021	1.4021
			420	420	420	420
14	Split ring		1.4104	1.4404	1.4104	1.4104
			Chrome steel	316L	Chrome steel	Chrome steel
15	Bellows	End pieces	2.4856	1.4404	2.4856	1.4404
			Inconel 625	316L	Inconel 625	316L
16 / 17	Spring plate		1.0718	1.4404	1.0718	1.0718
			Steel	316L	Steel	Steel
18	Adjusting screw with bushing		1.4104	1.4404 tenifer	1.4104	1.4104
			Chrome steel	316L tenifer	Chrome steel	Chrome steel
			PTFE 15% Glas	PTFE 15% Glas	PTFE 15% Glas	PTFE 15% Glas
			PTFE 15% Glas	PTFE 15% Glas	PTFE 15% Glas	PTFE 15% Glas
19	Lock nut		1.0718	1.4404	1.0718	1.0718
			Steel	316L	Steel	Steel
40	Cap H2		1.0718	1.4404	1.0718	1.0718
			Steel	316L	Steel	Steel
54	Spring		1.7102, 1.8159	1.4310	1.7102, 1.8159	1.7102, 1.8159
			High temp. alloy steel	Stainless steel	High temp. alloy steel	High temp. alloy steel
55	Stud		1.4401	1.4401	1.7709	1.4401
			B8M	B8M	B16	B8M
56	Nut		1.4401	1.4401	1.7258	1.4401
			8M	8M	7M	8M
57	Ball		1.4401	1.4401	1.4401	1.4401
			316	316	316	316
60	Gasket		Graphite / 1.4401	Graphite / 1.4401	Graphite / 1.4401	Graphite / 1.4401
			Graphite / 316	Graphite / 316	Graphite / 316	Graphite / 316
61	Ball		1.3541	1.4401	1.3541	1.3541
			Hardened stainless steel	316	Hardened stainless steel	Hardened stainless steel
66	Screw		1.4401	1.4401	1.4401	1.4401
			B8M	B8M	B8M	B8M
69	Needle bearing		1.4404	1.4404	1.4404	1.4404
			316L	316 L	316L	316L
73	Lock screw		1.4404	1.4404	1.4404	1.4404
			8M	8M	8M	8M

<sup>1)</sup> Stellited sealing surfaces please refer to page 99/06. LESER reserves also to use the nozzle material 1.4404/ 316L.

<sup>2)</sup> Valve size 6 R 10 and 8 T 10 without bonnet spacer

**Please notice:**

- Modifications reserved by LESER
- If several materials are specified LESER defines the material.
- LESER can upgrade materials without notice
- Every part can be replaced by other material acc. to customer specification.

**Special materials:**

Body and trim available in various materials (Monel®, Hastelloy® ...).  
For nozzle and disc machined from the bar a short lead time is possible.

## How to order – Example for numbering system

# 1

Article Number

5262.0012

# 2

Set Pressure

5 bar<sub>g</sub>

# 3

Connections

H45

1
2
3
4

526
2
.001
2

**1 Valve Type 526**

**2 Material code**

Code	Body + Bonnet material
2	WCB 1.6019
3	LCB
4	CF8M 1.4408
7	WC6 1.7357

**3 Valve code**

Identifies valve size, body material, orifice and flange class. Refer to page 01/08 and 01/09.

**4**

Code	Lifting device	
2	Screwed cap	H2
3	Plain lever	H3
4	Packed lever	H4
5	Plain lever with open bonnet	H3

Please state unit (in gauge)!

Please do not exceed the pressure range defined in the spring charts.

If different from API 526 Standard please refer to page 01/73.

## 4 Options

J22

Type 526	Option code
• RTJ-groove inlet	<b>L58</b>
• O-ring disc	
CR "K"	<b>J21</b>
EPDM "D"	<b>J22</b>
FKM "L"	<b>J23</b>
FFKM "C"	<b>J20</b>
• Disc 1.4404 / 316L	<b>L44</b>
• Disc 1.4404 / 316L stellite	<b>J25</b>
• Nozzle 1.4408 / CF8M stellite	<b>L62</b>
• Nozzle 1.4404 / 316L stellite	<b>L65</b>
• Nozzle 1.4404 / 316L	<b>L64</b>
• Balanced bellows	<b>J83</b>
- high temperature equipment (Type 5267 only)	<b>J88</b>
• Stainless steel spring	<b>X04</b>
• INCONEL spring	<b>X08</b>
• Adaptor for lift indicator H4	<b>J39</b>
• Lift indicator	<b>J93</b>
• Test gag	
- cap H2	<b>J70</b>
- packed lever H4	<b>J69</b>
• Free of oil and grease	<b>J85</b>
• Materials	
- NACE	<b>N78</b>
• Heating jacket	
- Couplings G 3/8	<b>H29</b>
G 3/4	<b>H30</b>
- Flanges DN 15	<b>H31</b>
DN 25	<b>H32</b>
1/2" class 150	<b>K31</b>
1" class 150	<b>K32</b>
• Bolted cap H1	<b>K01</b>
• Bolted lifting device H6	<b>K06</b>

Option code applies only if not standard

## 5 Documentation

H01 L30

Please select required documentation:

Inspections, tests:	Option code
DIN EN 10204-3.2: TÜV-Nord Certificate for test pressure	<b>M33</b>
<b>LESER CGA (Certificate for Global Application)</b>	<b>H03</b>
- Inspection certificate 3.1 acc. to DIN EN 10204	
- Declaration of conformity acc. to PED 97/23/EC	
<b>Material test certificate:</b>	
DIN EN 10204-3.1	
<b>Part</b>	<b>Option code</b>
Body	<b>H01</b>
Bonnet	<b>L30</b>
Cap / lever cover	<b>L31</b>
Nozzle	<b>L59</b>
Disc	<b>L23</b>
Studs	<b>N07</b>
Nuts	<b>N08</b>

## 6 Code and Medium

3.1

<b>1</b>	<b>2</b>
<b>3</b>	<b>1</b>
<b>1 Code</b>	
1. ASME Section VIII	
2. CE / VdTUEV	
3. ASME Section VIII + CE / VdTUEV	
<b>2 Medium</b>	
.1 Gases	
.2 Liquids	
.3 Steam	
.0 Steam / Gases / Liquids (valid only for CE / VdTUEV)	

## Article numbers – Overview

Type 526

Article numbers												
Material	WCB	CF8M	WC6	LCB	WCB	CF8M	WC6	LCB	WCB	CF8M	WC6	LCB
	1.0619	1.4408	1.7357		1.0619	1.4408	1.7357		1.0619	1.4408	1.7357	
Flange class				150 x 150	300L x 150				300 x 150			
Valve size				1 D 2	1 D 2				1 D 2			
D	5262.001 <sup>□</sup>	5264.010 <sup>□</sup>	–	5263.500 <sup>□</sup>	Use 1 D 2 300 x 150				5262.002 <sup>□</sup>	5264.011 <sup>□</sup>	5267.006 <sup>□</sup>	5263.501 <sup>□</sup>
Valve size				1 E 2	1 E 2				1 E 2			
E	5262.015 <sup>□</sup>	5264.024 <sup>□</sup>	–	5263.505 <sup>□</sup>	Use 1 E 2 300 x 150				5262.016 <sup>□</sup>	5264.025 <sup>□</sup>	5267.020 <sup>□</sup>	5263.506 <sup>□</sup>
Valve size				1 1/2 F 2	1 1/2 F 2				1 1/2 F 2			
F	5262.029 <sup>□</sup>	5264.039 <sup>□</sup>	–	5263.510 <sup>□</sup>	5262.030 <sup>□</sup>	5264.040 <sup>□</sup>	–	5263.511 <sup>□</sup>	5262.031 <sup>□</sup>	5264.041 <sup>□</sup>	5267.035 <sup>□</sup>	5263.512 <sup>□</sup>
Valve size				1 1/2 G 3	1 1/2 G 3				1 1/2 G 3			
G	5262.045 <sup>□</sup>	5264.110 <sup>□</sup>	–	5263.516 <sup>□</sup>	5262.046 <sup>□</sup>	5264.111 <sup>□</sup>	–	5263.517 <sup>□</sup>	5262.047 <sup>□</sup>	5264.112 <sup>□</sup>	5267.052 <sup>□</sup>	5263.518 <sup>□</sup>
Flange class				150 x 150	300L x 150				300 x 150			
Valve size				1 1/2 H 3	1 1/2 H 3				2 H 3			
H	5262.142 <sup>□</sup>	5264.152 <sup>□</sup>	–	5263.523 <sup>□</sup>	5262.143 <sup>□</sup>	5264.153 <sup>□</sup>	–	5263.524 <sup>□</sup>	5262.144 <sup>□</sup>	5264.154 <sup>□</sup>	5267.148 <sup>□</sup>	5263.525 <sup>□</sup>
Valve size				2 J 3	2 J 3				3 J 4			
J	5262.162 <sup>□</sup>	5264.196 <sup>□</sup>	–	5263.529 <sup>□</sup>	5262.163 <sup>□</sup>	5264.197 <sup>□</sup>	–	5263.530 <sup>□</sup>	5262.164 <sup>□</sup>	5264.198 <sup>□</sup>	5267.168 <sup>□</sup>	5263.531 <sup>□</sup>
Valve size				3 K 4	3 K 4				3 K 4			
K	5262.202 <sup>□</sup>	5264.211 <sup>□</sup>	–	5263.535 <sup>□</sup>	Use 3 K 4 300 x 150				5262.203 <sup>□</sup>	5264.212 <sup>□</sup>	5267.207 <sup>□</sup>	5263.536 <sup>□</sup>
Flange class				150 x 150	300L x 150				300 x 150			
Valve size				3 L 4	3 L 4				4 L 6			
L	5262.232 <sup>□</sup>	5264.242 <sup>□</sup>	–	5263.540 <sup>□</sup>	5262.233 <sup>□</sup>	5264.243 <sup>□</sup>	–	5263.541 <sup>□</sup>	5262.234 <sup>□</sup>	5264.244 <sup>□</sup>	5267.238 <sup>□</sup>	5263.542 <sup>□</sup>
Valve size				4 M 6	4 M 6				4 M 6			
M	5262.580 <sup>□</sup>	5264.587 <sup>□</sup>	–	5263.546 <sup>□</sup>	Use 4 M 6 300 x 150				5262.581 <sup>□</sup>	5264.588 <sup>□</sup>	5267.584 <sup>□</sup>	5263.547 <sup>□</sup>
Valve size				4 N 6	4 N 6				4 N 6			
N	5262.590 <sup>□</sup>	5264.597 <sup>□</sup>	–	5263.550 <sup>□</sup>	Use 4 N 6 300 x 150				5262.591 <sup>□</sup>	5264.598 <sup>□</sup>	5267.594 <sup>□</sup>	5263.551 <sup>□</sup>
Valve size				4 P 6	4 P 6				4 P 6			
P	5262.645 <sup>□</sup>	5264.653 <sup>□</sup>	–	5263.554 <sup>□</sup>	5262.646 <sup>□</sup>	5264.654 <sup>□</sup>	–	5263.555 <sup>□</sup>	5262.647 <sup>□</sup>	5264.655 <sup>□</sup>	5267.650 <sup>□</sup>	5263.556 <sup>□</sup>
Valve size				6 Q 8	6 Q 8				6 Q 8			
Q	5262.657 <sup>□</sup>	5264.662 <sup>□</sup>	–	5263.559 <sup>□</sup>	Use 6 Q 8 300 x 150				5262.658 <sup>□</sup>	5264.663 <sup>□</sup>	5267.660 <sup>□</sup>	5263.560 <sup>□</sup>
Valve size				6 R 8	6 R 8				6 R 10			
R	5262.665 <sup>□</sup>	5264.671 <sup>□</sup>	–	5263.562 <sup>□</sup>	5262.666 <sup>□</sup>	5264.672 <sup>□</sup>	5267.669 <sup>□</sup>	5263.563 <sup>□</sup>	5262.667 <sup>□</sup>	5264.673 <sup>□</sup>	–	5263.564 <sup>□</sup>
Valve size				8 T 10	8 T 10				8 T 10			
T	5262.675 <sup>□</sup>	5264.678 <sup>□</sup>	–	5263.566 <sup>□</sup>	Use 8 T 10 300 x 150				5262.676 <sup>□</sup>	5264.679 <sup>□</sup>	5267.677 <sup>□</sup>	5263.567 <sup>□</sup>

## Article numbers – Overview

Article numbers																
Material	WCB	CF8M	WC6	LCB	WCB	CF8M	WC6	LCB	WCB	CF8M	WC6	LCB	WCB	CF8M	WC6	LCB
	1.0619	1.4408	1.7357		1.0619	1.4408	1.7357		1.0619	1.4408	1.7357		1.0619	1.4408	1.7357	
<b>Flange class</b>	600 x 150				900 x 300				1500 x 300				2500 x 300			
<b>Valve size</b>	1 D 2				1 1/2 D 2				1 1/2 D 2				1 1/2 D 3			
<b>D</b>	5262.003 <sup>o</sup>	5264.012 <sup>o</sup>	5267.007 <sup>o</sup>	5263.502 <sup>o</sup>	Use 1 1/2 D 2 1500 x 300				5262.004 <sup>o</sup>	5264.013 <sup>o</sup>	5267.008 <sup>o</sup>	5263.503 <sup>o</sup>	5262.005 <sup>o</sup>	5264.014 <sup>o</sup>	5267.009 <sup>o</sup>	5263.504 <sup>o</sup>
<b>E</b>	1 E 2				1 1/2 E 2				1 1/2 E 2				1 1/2 E 3			
<b>E</b>	5262.017 <sup>o</sup>	5264.026 <sup>o</sup>	5267.021 <sup>o</sup>	5263.507 <sup>o</sup>	Use 1 1/2 E 2 1500 x 300				5262.018 <sup>o</sup>	5264.027 <sup>o</sup>	5267.022 <sup>o</sup>	5263.508 <sup>o</sup>	5262.019 <sup>o</sup>	5264.028 <sup>o</sup>	5267.023 <sup>o</sup>	5263.509 <sup>o</sup>
<b>F</b>	1 1/2 F 2				1 1/2 F 3				1 1/2 F 3				1 1/2 F 3			
<b>F</b>	5262.032 <sup>o</sup>	5264.042 <sup>o</sup>	5267.036 <sup>o</sup>	5263.513 <sup>o</sup>	Use 1 1/2 F 3 1500 x 300				5262.033 <sup>o</sup>	5264.043 <sup>o</sup>	5267.037 <sup>o</sup>	5263.514 <sup>o</sup>	5262.034 <sup>o</sup>	5264.044 <sup>o</sup>	5267.038 <sup>o</sup>	5263.515 <sup>o</sup>
<b>G</b>	1 1/2 G 3				1 1/2 G 3				2 G 3				2 G 3			
<b>G</b>	5262.048 <sup>o</sup>	5264.113 <sup>o</sup>	5267.053 <sup>o</sup>	5263.519 <sup>o</sup>	5262.049 <sup>o</sup>	5264.114 <sup>o</sup>	5267.054 <sup>o</sup>	5263.520 <sup>o</sup>	5262.050 <sup>o</sup>	5264.115 <sup>o</sup>	5267.055 <sup>o</sup>	5263.521 <sup>o</sup>	5262.051 <sup>o</sup>	5264.116 <sup>o</sup>	5267.056 <sup>o</sup>	5263.522 <sup>o</sup>
<b>Flange class</b>	600 x 150				900 x 150				1500 x 300							
<b>Valve size</b>	2 H 3				2 H 3				2 H 3							
<b>H</b>	5262.145 <sup>o</sup>	5264.155 <sup>o</sup>	5267.149 <sup>o</sup>	5263.526 <sup>o</sup>	5262.146 <sup>o</sup>	5264.156 <sup>o</sup>	5267.150 <sup>o</sup>	5263.527 <sup>o</sup>	5262.147 <sup>o</sup>	5264.157 <sup>o</sup>	5267.151 <sup>o</sup>	5263.528 <sup>o</sup>				
<b>J</b>	3 J 4				3 J 4				3 J 4							
<b>J</b>	5262.165 <sup>o</sup>	5264.199 <sup>o</sup>	5267.169 <sup>o</sup>	5263.532 <sup>o</sup>	5262.166 <sup>o</sup>	5264.200 <sup>o</sup>	5267.170 <sup>o</sup>	5263.533 <sup>o</sup>	5262.167 <sup>o</sup>	5264.201 <sup>o</sup>	5267.171 <sup>o</sup>	5263.534 <sup>o</sup>				
<b>K</b>	3 K 4				3 K 6				3 K 6							
<b>K</b>	5262.204 <sup>o</sup>	5264.213 <sup>o</sup>	5267.208 <sup>o</sup>	5263.537 <sup>o</sup>	5262.205 <sup>o</sup>	5264.214 <sup>o</sup>	5267.209 <sup>o</sup>	5263.538 <sup>o</sup>	5262.206 <sup>o</sup>	5264.215 <sup>o</sup>	5267.210 <sup>o</sup>	5263.539 <sup>o</sup>				
<b>Flange class</b>	600 x 150				900 x 150				1500 x 150							
<b>Valve size</b>	4 L 6				4 L 6				4 L 6							
<b>L</b>	5262.235 <sup>o</sup>	5264.245 <sup>o</sup>	5267.239 <sup>o</sup>	5263.543 <sup>o</sup>	5262.236 <sup>o</sup>	5264.246 <sup>o</sup>	5267.240 <sup>o</sup>	5263.544 <sup>o</sup>	5262.237 <sup>o</sup>	-	5267.241 <sup>o</sup>	5263.545 <sup>o</sup>				
<b>M</b>	4 M 6				4 M 6											
<b>M</b>	5262.582 <sup>o</sup>	5264.589 <sup>o</sup>	5267.585 <sup>o</sup>	5263.548 <sup>o</sup>	5262.583 <sup>o</sup>	-	5267.586 <sup>o</sup>	5263.549 <sup>o</sup>								
<b>N</b>	4 N 6				4 N 6											
<b>N</b>	5262.592 <sup>o</sup>	5264.599 <sup>o</sup>	5267.595 <sup>o</sup>	5263.552 <sup>o</sup>	5262.593 <sup>o</sup>	-	5267.596 <sup>o</sup>	5263.553 <sup>o</sup>								
<b>P</b>	4 P 6				4 P 6											
<b>P</b>	5262.648 <sup>o</sup>	5264.656 <sup>o</sup>	5267.651 <sup>o</sup>	5263.557 <sup>o</sup>	5262.649 <sup>o</sup>	-	5267.652 <sup>o</sup>	5263.558 <sup>o</sup>								
<b>Q</b>	6 Q 8															
<b>Q</b>	5262.659 <sup>o</sup>	5264.664 <sup>o</sup>	5267.661 <sup>o</sup>	5263.561 <sup>o</sup>												
<b>R</b>	6 R 10															
<b>R</b>	5262.668 <sup>o</sup>	5264.674 <sup>o</sup>	5267.670 <sup>o</sup>	5263.565 <sup>o</sup>												
<b>T</b>	8 T 10															
<b>T</b>	-	-	-	-												

<sup>o</sup>) Please add code for the required cap or lifting device.

Code for lifting device	H2	H3	H4	H3
Bonnet	closed	closed	closed	open
WCB 1.0619, WC6 1.7357, LCB	2	3	4	5
CF8M 1.4408	2	-	4	-



# Type 526

## Dimensions

### Metric Units

Safety valve dimensions [mm]		a	b	s	H <sub>max.</sub>	H <sub>max.</sub> with bellows	a	b	s	H <sub>max.</sub>	H <sub>max.</sub> with bellows	a	b	s	H <sub>max.</sub>	H <sub>max.</sub> with bellows
Support brackets [mm]		A	B	C	D	E	A	B	C	D	E	A	B	C	D	E
<b>Flange rating class</b>		<b>150 x 150</b>					<b>300L x 150</b>					<b>300 x 150</b>				
<b>Valve size</b>		1 D 2					1 D 2					1 D 2				
<b>D</b>	d <sub>0</sub> [mm]	14.0	105	114	30	440	Please see 1 D 2					105	114	30	440	465
	A <sub>0</sub> [mm <sup>2</sup> ]	154	130	-	Ø 14	132	300 x 150					130	-	Ø 14	132	16
<b>Valve size</b>		1 E 2					1 E 2					1 E 2				
<b>E</b>	d <sub>0</sub> [mm]	14.0	105	114	30	440	Please see 1 E 2					105	114	30	440	465
	A <sub>0</sub> [mm <sup>2</sup> ]	154	130	-	Ø 14	132	300 x 150					130	-	Ø 14	132	16
<b>Valve size</b>		1 1/2 F 2					1 1/2 F 2					1 1/2 F 2				
<b>F</b>	d <sub>0</sub> [mm]	18.0	124	121	32	536	124	121	32	536	561	124	152	35	536	561
	A <sub>0</sub> [mm <sup>2</sup> ]	254	162	-	Ø 14	148	162	-	Ø 14	148	16	162	-	Ø 14	148	16
<b>Valve size</b>		1 1/2 G 3					1 1/2 G 3					1 1/2 G 3				
<b>G</b>	d <sub>0</sub> [mm]	22.5	124	121	32	536	124	121	32	536	574	124	152	35	536	574
	A <sub>0</sub> [mm <sup>2</sup> ]	398	162	-	Ø 14	148	162	-	Ø 14	148	16	162	-	Ø 14	148	16
<b>Flange rating class</b>		<b>150 x 150</b>					<b>300L x 150</b>					<b>300 x 150</b>				
<b>Valve size</b>		1 1/2 H 3					1 1/2 H 3					2 H 3				
<b>H</b>	d <sub>0</sub> [mm]	28.3	130	124	38	542	130	124	38	542	580	130	124	43	666	692
	A <sub>0</sub> [mm <sup>2</sup> ]	629	162	-	Ø 14	155	162	-	Ø 14	155	16	184	110	Ø 14	177	16
<b>Valve size</b>		2 J 3					2 J 3					3 J 4				
<b>J</b>	d <sub>0</sub> [mm]	36.0	137	124	49	673	137	124	49	673	722	184	181	49	786	824
	A <sub>0</sub> [mm <sup>2</sup> ]	1018	184	110	Ø 14	184	16	184	110	Ø 14	184	16	238	140	Ø 18	234
<b>Valve size</b>		3 K 4					3 K 4					3 K 4				
<b>K</b>	WCB, LCB, d <sub>0</sub> [mm]	43.0	156	162	49	758	Please see 3 K 4					156	162	49	758	796
	CF8M (WC6) A <sub>0</sub> [mm <sup>2</sup> ]	1452	238	140	Ø 18	206	300 x 150					238	140	Ø 18	206	25
<b>Valve size</b>		3 L 4					3 L 4					4 L 6				
<b>L</b>	d <sub>0</sub> [mm]	53.5	156	165	49	758	156	165	49	758	796	179	181	49	853	886
	A <sub>0</sub> [mm <sup>2</sup> ]	2248	238	140	Ø 18	206	25	238	140	Ø 18	206	25	278	160	Ø 18	262
<b>Valve size</b>		4 M 6					4 M 6					4 M 6				
<b>M</b>	d <sub>0</sub> [mm]	60.3	178	184	48	852	Please see 4 M 6					178	184	48	852	885
	A <sub>0</sub> [mm <sup>2</sup> ]	2856	278	160	Ø 18	260	300 x 150					278	160	Ø 18	260	25
<b>Valve size</b>		4 N 6					4 N 6					4 N 6				
<b>N</b>	d <sub>0</sub> [mm]	66.0	197	210	48	871	Please see 4 N 6					197	210	48	871	904
	A <sub>0</sub> [mm <sup>2</sup> ]	3421	278	160	Ø 18	280	300 x 150					278	160	Ø 18	280	25
<b>Valve size</b>		4 P 6					4 P 6					4 P 6				
<b>P</b>	d <sub>0</sub> [mm]	80.0	181	229	48	855	181	229	48	855	888	225	254	62	1079	1138
	A <sub>0</sub> [mm <sup>2</sup> ]	5027	278	160	Ø 18	262	25	278	160	Ø 18	262	25	370	210	Ø 18	306
<b>Valve size</b>		6 Q 8					6 Q 8					6 Q 8				
<b>Q</b>	d <sub>0</sub> [mm]	105.5	240	241	68	1120	Please see 6 Q 8					240	241	68	1120	1200
	A <sub>0</sub> [mm <sup>2</sup> ]	8742	370	210	Ø 18	346	300 x 150					370	210	Ø 18	346	25
<b>Valve size</b>		6 R 8					6 R 8					6 R 10				
<b>R</b>	d <sub>0</sub> [mm]	126.0	240	241	68	1120	240	241	68	1120	1200	240	267	68	1426	1426
	A <sub>0</sub> [mm <sup>2</sup> ]	12568	370	210	Ø 18	346	25	370	210	Ø 18	346	25	470	150	Ø 18	460
<b>Valve size</b>		8 T 10					8 T 10					8 T 10				
<b>T</b>	d <sub>0</sub> [mm]	161.5	276	279	62	1462	Please see 8 T 10					276	279	62	1462	1462
	A <sub>0</sub> [mm <sup>2</sup> ]	20485	470	150	Ø 18	497	300 x 150					470	150	Ø 18	497	25

$d_0$  = Actual orifice diameter  
 $A_0$  = Actual orifice area

a	b	s	H <sub>max.</sub>	H <sub>max.</sub> with bellows	a	b	s	H <sub>max.</sub>	H <sub>max.</sub> with bellows	a	b	s	H <sub>max.</sub>	H <sub>max.</sub> with bellows	a	b	s	H <sub>max.</sub>	H <sub>max.</sub> with bellows
A	B	C	D	E	A	B	C	D	E	A	B	C	D	E	A	B	C	D	E
<b>600 x 150</b>					<b>900 x 300</b>					<b>1500 x 300</b>					<b>2500 x 300</b>				
1 D 2					1 1/2 D 2					1 1/2 D 2					1 1/2 D 3				
105	114	30	440	465	Please see 1 1/2 D 2					105	140	44	517	542	140	178	57	576	576
130	-	Ø 14	132	16	1500 x 300					162	-	Ø 14	129	16	162	-	Ø 14	189	16
1 E 2					1 1/2 E 2					1 1/2 E 2					1 1/2 E 3				
105	114	30	440	465	Please see 1 1/2 E 2					105	140	44	517	542	140	178	57	576	576
130	-	Ø 14	132	16	1500 x 300					162	-	Ø 14	129	16	162	-	Ø 14	189	16
1 1/2 F 2					1 1/2 F 3					1 1/2 F 3					1 1/2 F 3				
124	152	35	536	561	Please see 1 1/2 F 3					124	165	44	560	560	140	178	57	576	576
162	-	Ø 14	148	16	1500 x 300					162	-	Ø 14	174	16	162	-	Ø 14	189	16
1 1/2 G 3					1 1/2 G 3					2 G 3					2 G 3				
124	152	35	536	574	124	165	44	560	573	156	172	68	688	705	156	172	68	688	705
162	-	Ø 14	148	16	162	-	Ø 14	174	16	184	110	Ø 14	198	16	184	110	Ø 14	198	16
<b>600 x 150</b>					<b>900 x 150</b>					<b>1500 x 300</b>									
2 H 3					2 H 3					2 H 3									
154	162	56	691	717	154	162	56	691	717	154	162	56	691	717					
184	110	Ø 14	202	16	184	110	Ø 14	202	16	184	110	Ø 14	202	16					
3 J 4					3 J 4					3 J 4									
184	181	49	786	824	184	181	65	786	824	184	181	65	786	824					
238	140	Ø 18	234	25	238	140	Ø 18	234	25	238	140	Ø 18	234	25					
3 K 4					3 K 6					3 K 6									
184	181	49	786	824	198	216	67	880	880	197	216	65	879	879					
238	140	Ø 18	234	25	278	160	Ø 18	288	25	278	160	Ø 18	287	25					
156	162	49	758	796															
238	140	Ø 18	206	25															
<b>600 x 150</b>					<b>900 x 150</b>					<b>1500 x 150</b>									
4 L 6					4 L 6					4 L 6									
179	203	57	853	886	197	222	72	871	904	197	222	72	871	904					
278	160	Ø 18	262	25	278	160	Ø 18	280	25	278	160	Ø 18	280	25					
4 M 6					4 M 6					4 M 6									
178	203	56	852	885	197	222	72	871	904	197	222	72	871	904					
278	160	Ø 18	260	25	278	160	Ø 18	280	25	278	160	Ø 18	280	25					
4 N 6					4 N 6					4 N 6									
197	222	72	871	904	197	222	72	871	904	197	222	72	871	904					
278	160	Ø 18	280	25	278	160	Ø 18	280	25	278	160	Ø 18	280	25					
4 P 6					4 P 6					4 P 6									
225	254	62	1079	1138	225	254	62	1079	1138	225	254	62	1079	1138					
370	210	Ø 18	306	25	370	210	Ø 18	306	25	370	210	Ø 18	306	25					
6 Q 8					6 Q 8					6 Q 8									
240	241	68	1120	1200															
370	210	Ø 18	346	25															
6 R 10					6 R 10					6 R 10									
240	267	68	1426	1426															
470	150	Ø 18	460	25															
-	-	-	-	-															
-	-	-	-	-															
-	-	-	-	-															

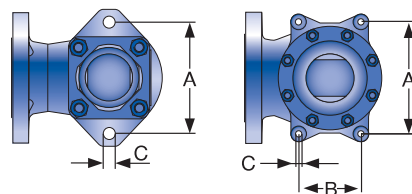

Support brackets

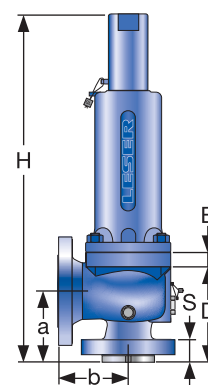

Conventional design

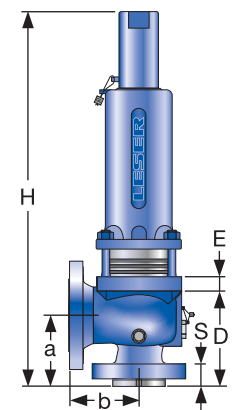

Balanced bellows design

# Type 526

## Dimensions

### US Units

Safety valve dimensions [inch]		a	b	s	H <sub>max.</sub>	H <sub>max.</sub> with bellows	a	b	s	H <sub>max.</sub>	H <sub>max.</sub> with bellows	a	b	s	H <sub>max.</sub>	H <sub>max.</sub> with bellows	
Support brackets [inch]		A	B	C	D	E	A	B	C	D	E	A	B	C	D	E	
<b>Flange rating class</b>		<b>150 x 150</b>					<b>300L x 150</b>					<b>300 x 150</b>					
<b>Valve size</b>		1 D 2					1 D 2					1 D 2					
<b>D</b>	d <sub>0</sub> [inch]	<b>0.552</b>	4 1/8	4 1/2	1 3/16	17 5/16	18 5/16	Please see 1 D 2					4 1/8	4 1/2	1 3/16	17 5/16	18 5/16
	A <sub>0</sub> [inch <sup>2</sup> ]	<b>0.239</b>	5 1/8	-	Ø 9/16	5 7/32	5/8	300 x 150					5 1/8	-	Ø 9/16	5 7/32	5/8
<b>Valve size</b>		1 E 2					1 E 2					1 E 2					
<b>E</b>	d <sub>0</sub> [inch]	<b>0.552</b>	4 1/8	4 1/2	1 3/16	17 5/16	18 5/16	Please see 1 E 2					4 1/8	4 1/2	1 3/16	17 5/16	18 5/16
	A <sub>0</sub> [inch <sup>2</sup> ]	<b>0.239</b>	5 1/8	-	Ø 9/16	5 7/32	5/8	300 x 150					5 1/8	-	Ø 9/16	5 7/32	5/8
<b>Valve size</b>		1 1/2 F 2					1 1/2 F 2					1 1/2 F 2					
<b>F</b>	d <sub>0</sub> [inch]	<b>0.709</b>	4 7/8	4 3/4	1 1/4	21 3/32	22 3/32	4 7/8	4 3/4	1 1/4	21 3/32	22 3/32	4 7/8	6	1 13/32	21 3/32	22 3/32
	A <sub>0</sub> [inch <sup>2</sup> ]	<b>0.394</b>	6 3/8	-	Ø 9/16	5 27/32	5/8	6 3/8	-	Ø 9/16	5 27/32	5/8	6 3/8	-	Ø 14	5 27/32	5/8
<b>Valve size</b>		1 1/2 G 3					1 1/2 G 3					1 1/2 G 3					
<b>G</b>	d <sub>0</sub> [inch]	<b>0.886</b>	4 7/8	4 3/4	1 1/4	21 3/32	22 19/32	4 7/8	4 3/4	1 1/4	21 3/32	22 19/32	4 7/8	6	1 13/32	21 3/32	22 19/32
	A <sub>0</sub> [inch <sup>2</sup> ]	<b>0.617</b>	6 3/8	-	Ø 9/16	5 27/32	5/8	6 3/8	-	Ø 9/16	5 27/32	5/8	6 3/8	-	Ø 9/16	5 27/32	5/8
<b>Flange rating class</b>		<b>150 x 150</b>					<b>300L x 150</b>					<b>300 x 150</b>					
<b>Valve size</b>		1 1/2 H 3					1 1/2 H 3					2 H 3					
<b>H</b>	d <sub>0</sub> [inch]	<b>1.11</b>	5 1/8	4 7/8	1 1/2	21 11/32	22 27/32	5 1/8	4 7/8	1 1/2	21 11/32	22 27/32	5 1/8	4 7/8	1 11/16	26 7/32	27 1/4
	A <sub>0</sub> [inch <sup>2</sup> ]	<b>0.98</b>	6 3/8	-	Ø 9/16	6 3/32	5/8	6 3/8	-	Ø 9/16	6 3/32	5/8	7 1/4	4 11/32	Ø 9/16	6 31/32	5/8
<b>Valve size</b>		2 J 3					2 J 3					3 J 4					
<b>J</b>	d <sub>0</sub> [inch]	<b>1.42</b>	5 3/8	4 7/8	1 15/16	26 1/2	28 7/16	5 3/8	4 7/8	1 15/16	26 1/2	28 7/16	7 1/4	7 1/8	1 15/16	30 15/16	32 7/16
	A <sub>0</sub> [inch <sup>2</sup> ]	<b>1.58</b>	7 1/4	4 11/32	Ø 9/16	7 1/4	5/8	7 1/4	4 11/32	Ø 9/16	7 1/4	5/8	9 3/8	5 1/2	Ø 23/32	9 7/32	31/32
<b>Valve size</b>		3 K 4					3 K 4					3 K 4					
<b>K</b>	WCB, LCB, d <sub>0</sub> [inch]	<b>1.69</b>	6 1/8	6 3/8	1 15/16	29 27/32	23 11/32	Please see 3 K 4					6 1/8	6 3/8	1 15/16	29 27/32	31 11/32
	CF8M (WC6) A <sub>0</sub> [inch <sup>2</sup> ]	<b>2.25</b>	9 3/8	5 1/2	Ø 23/32	8 3/32	31/32	300 x 150					9 3/8	5 1/2	Ø 23/32	8 3/32	31/32
<b>WC6</b>																	
<b>Flange rating class</b>		<b>150 x 150</b>					<b>300L x 150</b>					<b>300 x 150</b>					
<b>Valve size</b>		3 L 4					3 L 4					4 L 6					
<b>L</b>	d <sub>0</sub> [inch]	<b>2.11</b>	6 1/8	6 1/2	1 15/16	23 27/32	31 11/12	6 1/8	6 1/2	1 15/16	29 27/32	31 11/12	7 1/6	7 1/8	1 15/16	33 19/32	34 7/8
	A <sub>0</sub> [inch <sup>2</sup> ]	<b>3.48</b>	9 3/8	5 1/2	Ø 23/32	8 3/32	31/32	9 3/8	5 1/2	Ø 23/32	8 3/32	31/32	10 15/16	6 5/16	Ø 23/32	10 5/16	31/32
<b>Valve size</b>		4 M 6					4 M 6					4 M 6					
<b>M</b>	d <sub>0</sub> [inch]	<b>2.37</b>	7	7 1/4	1 7/8	33 17/32	34 27/32	Please see 4 M 6					7	7 1/4	1 7/8	33 17/32	34 27/32
	A <sub>0</sub> [inch <sup>2</sup> ]	<b>4.43</b>	10 15/16	6 5/16	Ø 23/32	10 1/4	31/32	300 x 150					10 15/16	6 5/16	Ø 23/32	10 1/4	31/32
<b>Valve size</b>		4 N 6					4 N 6					4 N 6					
<b>N</b>	d <sub>0</sub> [inch]	<b>2.60</b>	7 3/4	8 1/4	1 7/8	34 9/32	35 19/32	Please see 4 N 6					7 3/4	8 1/4	1 7/8	34 9/32	35 19/32
	A <sub>0</sub> [inch <sup>2</sup> ]	<b>5.30</b>	10 15/16	6 5/16	Ø 23/32	11	31/32	300 x 150					10 15/16	6 5/16	Ø 23/32	11	31/32
<b>Valve size</b>		4 P 6					4 P 6					4 P 6					
<b>P</b>	d <sub>0</sub> [inch]	<b>3.15</b>	7 1/8	9	1 7/8	33 31/32	34 31/32	7 1/8	9	1 7/8	33 31/32	34 31/32	8 7/8	10	2 7/16	42 1/2	44 13/16
	A <sub>0</sub> [inch <sup>2</sup> ]	<b>7.79</b>	10 15/16	6 5/16	Ø 23/32	10 5/16	31/32	10 15/16	6 5/16	Ø 23/32	10 5/16	31/32	14 9/16	8 9/32	Ø 23/32	12 1/16	31/32
<b>Valve size</b>		6 Q 8					6 Q 8					6 Q 8					
<b>Q</b>	d <sub>0</sub> [inch]	<b>4.15</b>	9 7/16	9 1/2	2 11/16	44 1/8	47 1/4	Please see 6 Q 8					9 7/16	9 1/2	2 11/16	44 1/8	47 1/4
	A <sub>0</sub> [inch <sup>2</sup> ]	<b>13.55</b>	14 9/16	8 9/32	Ø 23/32	13 5/8	31/32	300 x 150					14 9/16	8 9/32	Ø 23/32	13 5/8	31/32
<b>Valve size</b>		6 R 8					6 R 8					6 R 10					
<b>R</b>	d <sub>0</sub> [inch]	<b>4.96</b>	9 7/16	9 1/2	2 11/16	44 1/8	47 1/4	9 7/16	9 1/2	2 11/16	41 5/8	44 3/4	9 7/16	10 1/2	2 11/16	56 1/8	56 1/8
	A <sub>0</sub> [inch <sup>2</sup> ]	<b>19.48</b>	14 9/16	8 9/32	Ø 23/32	13 5/8	31/32	14 9/16	8 9/32	Ø 23/32	13 5/8	31/32	18 1/2	5 29/32	Ø 23/32	18 1/8	31/32
<b>Valve size</b>		8 T 10					8 T 10					8 T 10					
<b>T</b>	d <sub>0</sub> [inch]	<b>6.36</b>	10 7/8	11	2 7/16	57 9/16	57 9/16	Please see 8 T 10					10 7/8	11	2 7/16	57 9/16	57 9/16
	A <sub>0</sub> [inch <sup>2</sup> ]	<b>31.75</b>	18 1/2	5 29/32	Ø 23/32	19 9/16	31/32	300 x 150					18 1/2	5 29/32	Ø 23/32	19 9/16	31/32

$d_0$  = Actual orifice diameter  
 $A_0$  = Actual orifice area

a	b	s	H <sub>max.</sub>	H <sub>max.</sub> with bellows	a	b	s	H <sub>max.</sub>	H <sub>max.</sub> with bellows	a	b	s	H <sub>max.</sub>	H <sub>max.</sub> with bellows	a	b	s	H <sub>max.</sub>	H <sub>max.</sub> with bellows
A	B	C	D	E	A	B	C	D	E	A	B	C	D	E	A	B	C	D	E
<b>600 x 150</b>					<b>900 x 300</b>					<b>1500 x 300</b>					<b>2500 x 300</b>				
1 D 2					1 1/2 D 2					1 1/2 D 2					1 1/2 D 3				
4 1/8	4 1/2	1 3/16	17 5/16	18 5/16	Please see 1 1/2 D 2 1500 x 300					4 1/8	5 1/2	1 3/4	20 11/32	21 11/32	5 1/2	7	2 1/4	22 11/16	22 11/16
5 1/8	-	Ø 9/16	5 7/32	5/8						6 3/8	-	Ø 9/16	5 3/32	5/8	6 3/8	-	Ø 9/16	7 15/32	5/8
1 E 2					1 1/2 E 2					1 1/2 E 2					1 1/2 E 3				
4 1/8	4 1/2	1 3/16	17 5/16	18 5/16	Please see 1 1/2 E 2 1500 x 300					4 1/8	5 1/2	1 3/4	20 11/32	21 11/32	5 1/2	7	2 1/4	22 11/16	22 11/16
5 1/8	-	Ø 9/16	5 7/32	5/8						6 3/8	-	Ø 9/16	5 3/32	5/8	6 3/8	-	Ø 9/16	7 15/32	5/8
1 1/2 F 2					1 1/2 F 3					1 1/2 F 3					1 1/2 F 3				
4 7/8	6	1 13/32	21 3/32	22 3/32	Please see 1 1/2 F 3 1500 x 300					4 7/8	6 1/2	1 3/4	22 1/16	22 1/16	5 1/2	7	2 1/4	22 11/16	22 11/16
6 3/8	-	Ø 9/16	5 27/32	5/8						6 3/8	-	Ø 9/16	6 27/32	5/8	6 3/8	-	Ø 9/16	7 15/32	5/8
1 1/2 G 3					1 1/2 G 3					2 G 3					2 G 3				
4 7/8	6	1 13/32	21 3/32	22 19/32	4 7/8	6 1/2	1 3/4	22 1/16	22 9/16	6 1/8	6 3/4	2 11/16	27 3/32	27 3/4	6 1/8	6 3/4	2 11/16	27 3/32	27 3/4
6 3/8	-	Ø 9/16	5 27/32	5/8	6 3/8	-	Ø 14	6 27/32	5/8	7 1/4	4 11/32	Ø 9/16	7 13/16	5/8	7 1/4	4 11/32	Ø 9/16	7 13/16	5/8
<b>600 x 150</b>					<b>900 x 150</b>					<b>1500 x 300</b>									
2 H 3					2 H 3					2 H 3									
6 1/16	6 3/8	2 3/16	27 7/32	28 7/32	6 1/16	6 3/8	2 3/16	27 7/32	28 7/32	6 1/16	6 3/8	2 3/16	27 7/32	28 7/32					
7 1/4	4 11/32	Ø 9/16	7 15/16	5/8	7 1/4	4 11/32	Ø 9/16	7 15/16	5/8	7 1/4	4 11/32	Ø 9/16	7 15/16	5/8					
3 J 4					3 J 4					3 J 4									
7 1/4	7 1/8	1 15/16	30 15/16	32 7/16	7 1/4	7 1/8	2 9/16	30 15/16	32 7/16	7 1/4	7 1/8	2 3/16	30 15/16	32 7/16					
9 3/8	5 1/2	Ø 23/32	9 7/32	31/32	9 3/8	5 1/2	Ø 23/32	9 7/32	31/32	9 3/8	5 1/2	Ø 23/32	9 7/32	31/32					
3 K 4					3 K 6					3 K 6									
7 1/4	7 1/8	1 15/16	30 15/16	32 7/16	7 13/16	8 1/2	2 9/16	34 21/32	34 21/32	7 3/4	8 1/2	2 9/16	34 19/32	34 19/32					
9 3/8	5 1/2	Ø 23/32	9 7/32	31/32	10 15/16	6 5/16	Ø 23/32	11 11/32	31/32	10 15/16	6 5/16	Ø 23/32	10 15/16	31/32					
6 1/8	6 3/8	1 15/16	29 27/32	31 11/32															
9 3/8	5 1/2	Ø 23/32	8 3/32	31/32															
<b>600 x 150</b>					<b>900 x 150</b>					<b>1500 x 150</b>									
4 L 6					4 L 6					4 L 6									
7 1/16	8	2 1/4	33 19/32	34 7/8	7 3/4	8 3/4	2 3/4	34 9/32	35 19/32	7 3/4	8 3/4	2/34	34 9/32	35 19/32					
10 15/16	6 5/16	Ø 23/32	10 15/16	31/32	10 15/16	6 5/16	Ø 23/32	11	31/32	10 15/16	6 5/16	Ø 23/32	11	31/32					
4 M 6					4 M 6														
7	8	2 3/16	33 17/32	34 27/32	7 3/4	8 3/4	2 3/4	34 9/32	35 19/32										
10 15/16	6 5/16	Ø 23/32	10 1/4	31/32	10 15/16	6 5/16	Ø 23/32	11	31/32										
4 N 6					4 N 6														
7 3/4	8 3/4	2 3/4	34 9/32	35 19/32	7 3/4	8 3/4	2 3/4	34 9/32	35 19/32										
10 15/16	6 5/16	Ø 23/32	11	31/32	10 15/16	6 5/16	Ø 23/32	11	31/32										
4 P 6					4 P 6														
8 7/8	10	2 7/16	42 1/2	44 13/16	8 7/8	10	2 7/16	42 1/2	44 13/16										
14 9/16	8 9/32	Ø 23/32	12 1/16	31/32	14 9/16	8 9/32	Ø 23/32	12 1/16	31/32										
6 Q 8																			
9 7/16	9 1/2	2 11/16	44 1/8	47 1/4															
14 9/16	8 9/32	Ø 23/32	13 5/8	31/32															
6 R 10																			
9 7/16	10 1/2	2 11/16	56 1/8	56 1/8															
18 1/2	5 29/32	Ø 23/32	18 1/8	31/32															
-	-	-	-	-															
-	-	-	-	-															

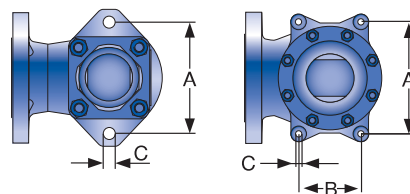

Support brackets

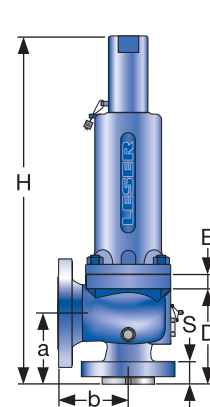

Conventional design

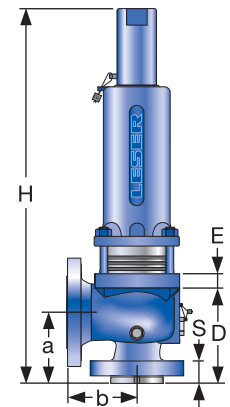

Balanced bellows design

## Weights

### Metric Units

		Bonnet			all			
		Lifting device			all			
Flange class		150 x 150	300L x 150	300 x 150	600 x 150	900 x 300	1500 x 300	2500 x 300
<b>Valve size</b>		1 D 2	1 D 2	1 D 2	1 D 2	1 1/2 D 2	1 1/2 D 2	1 1/2 D 3
<b>D</b>	Weight [kg]	17.3	17.3	17.3	17.3	31.1	31.1	41.8
	with bellows [kg]	18.4	18.4	18.4	18.4	33.1	33.1	44.6
<b>E</b>	Weight [kg]	17.3	17.3	17.3	17.3	31.1	31.1	41.8
	with bellows [kg]	18.4	18.4	18.4	18.4	33.1	33.1	44.6
<b>F</b>	Weight [kg]	30.6	30.6	32.5	32.5	36.3	36.3	41.8
	with bellows [kg]	33.1	33.1	35.0	35.0	38.6	38.6	44.6
<b>G</b>	Weight [kg]	30.6	30.6	32.5	32.5	36.3	69.9	69.9
	with bellows [kg]	33.1	33.1	35.0	35.0	38.6	72.5	72.5
Flange class		150 x 150	300L x 150	300 x 150	600 x 150	900 x 150	1500 x 300	
<b>Valve size</b>		1 1/2 H 3	1 1/2 H 3	2 H 3	2 H 3	2 H 3	2 H 3	
<b>H</b>	Weight [kg]	30.6	30.6	34.0	62.2	62.2	62.2	
	with bellows [kg]	33.1	33.1	37.8	65.3	65.3	65.3	
<b>J</b>	Weight [kg]	34.0	34.0	77.7	77.7	100.2	100.2	
	with bellows [kg]	37.8	37.8	83.2	83.2	105.7	105.7	
<b>K</b>	Weight [kg]	70.1	70.1	70.1	77.7	70.1	127.5	127.5
	with bellows [kg]	75.7	75.7	75.7	83.2	75.7	134.1	134.1
					<b>Other</b>	<b>WC6</b>		
Flange class		150 x 150	300L x 150	300 x 150	600 x 150	900 x 150	1500 x 150	
<b>Valve size</b>		3 L 4	3 L 4	4 L 6	4 L 6	4 L 6	4 L 6	
<b>L</b>	Weight [kg]	70.1	70.1	112.2	122.0	134.1	127.5	
	with bellows [kg]	75.7	75.7	118.8	128.6	140.7	134.1	
<b>M</b>	Weight [kg]	112.1	112.1	112.1	122.0	134.1		
	with bellows [kg]	118.7	118.7	118.7	128.6	140.7		
<b>N</b>	Weight [kg]	128.6	128.6	128.6	134.1	134.1		
	with bellows [kg]	135.2	135.2	135.2	140.7	140.7		
<b>P</b>	Weight [kg]	107.7	107.7	164.0	164.0	164.0		
	with bellows [kg]	114.8	114.8	172.0	172.0	172.0		
<b>Q</b>	Weight [kg]	221.0	221.0	221.0	221.0			
	with bellows [kg]	230.0	230.0	230.0	230.0			
<b>R</b>	Weight [kg]	221.0	221.0	277.0	277.0			
	with bellows [kg]	230.0	230.0	288.0	288.0			
<b>T</b>	Weight [kg]	287.0	287.0	287.0				
	with bellows [kg]	298.0	298.0	298.0				



## Weights

US Units		Bonnet		all				
		Lifting device		all				
Flange class		150 x 150	300L x 150	300 x 150	600 x 150	900 x 300	1500 x 300	2500 x 300
<b>Valve size</b>		1 D 2	1 D 2	1 D 2	1 D 2	1 1/2 D 2	1 1/2 D 2	1 1/2 D 3
<b>D</b>	Weight [lbs]	38.1	38.1	38.1	38.1	68.6	68.6	92.2
	with bellows [lbs]	40.6	40.6	40.6	40.6	73.0	73.0	98.3
<b>E</b>	Weight [lbs]	38.1	38.1	38.1	38.1	68.6	68.6	92.2
	with bellows [lbs]	40.6	40.6	40.6	40.6	73.0	73.0	98.3
<b>F</b>	Weight [lbs]	67.5	67.5	71.7	71.7	80.0	80.0	92.2
	with bellows [lbs]	73.0	73.0	77.2	77.2	85.1	85.1	98.3
<b>G</b>	Weight [lbs]	67.5	67.5	71.7	71.7	80.0	154.1	154.1
	with bellows [lbs]	73.0	73.0	77.2	77.2	85.0	159.9	159.9
Flange class		150 x 150	300L x 150	300 x 150	600 x 150	900 x 150	1500 x 300	
<b>Valve size</b>		1 1/2 H 3	1 1/2 H 3	2 H 3	2 H 3	2 H 3	2 H 3	
<b>H</b>	Weight [lbs]	67.5	67.5	76.0	137.2	137.2	137.2	
	with bellows [lbs]	73.0	73.0	84.4	144.0	144.0	144.0	
<b>J</b>	Weight [lbs]	76.0	76.0	171.3	171.3	220.9	220.9	
	with bellows [lbs]	84.4	84.4	183.5	183.5	233.1	233.1	
<b>K</b>	Weight [lbs]	154.6	154.6	154.6	171.3	154.6	281.1	281.1
	with bellows [lbs]	166.9	166.9	166.9	183.5	166.9	295.7	295.7
					<b>Other</b>	<b>WC6</b>		
Flange class		150 x 150	300L x 150	300 x 150	600 x 150	900 x 150	1500 x 150	
<b>Valve size</b>		3 L 4	3 L 4	4 L 6	4 L 6	4 L 6	4 L 6	
<b>L</b>	Weight [lbs]	154.6	154.6	247.4	269.0	295.7	281.1	
	with bellows [lbs]	166.9	166.9	262.0	283.6	310.2	295.7	
<b>M</b>	Weight [lbs]	247.2	247.2	247.2	269.0	295.7		
	with bellows [lbs]	261.7	261.7	261.7	283.6	310.2		
<b>N</b>	Weight [lbs]	283.6	283.6	283.6	295.7	295.7		
	with bellows [lbs]	298.1	298.1	298.1	310.2	310.2		
<b>P</b>	Weight [lbs]	237.5	237.5	361.6	361.6	361.6		
	with bellows [lbs]	253.1	253.1	379.2	379.2	379.2		
<b>Q</b>	Weight [lbs]	487.3	487.3	487.3	487.3			
	with bellows [lbs]	507.2	507.2	507.2	507.2			
<b>R</b>	Weight [lbs]	487.3	487.3	610.8	610.8			
	with bellows [lbs]	507.2	507.2	635.0	635.0			
<b>T</b>	Weight [lbs]	632.8	632.8	632.8				
	with bellows [lbs]	657.1	657.1	657.1				

## Selection chart

	150 x 150	300L x 150	300 x 150	600 x 150	900 x 300	1500 x 300	2500 x 300
WCB	5262.001X	See 300 x 150	5262.002X	5262.003X	See 1500 x 300	5262.004X	5262.005X
WC6	-	See 300 x 150	5267.006X	5267.007X	See 1500 x 300	5267.008X	5267.009X

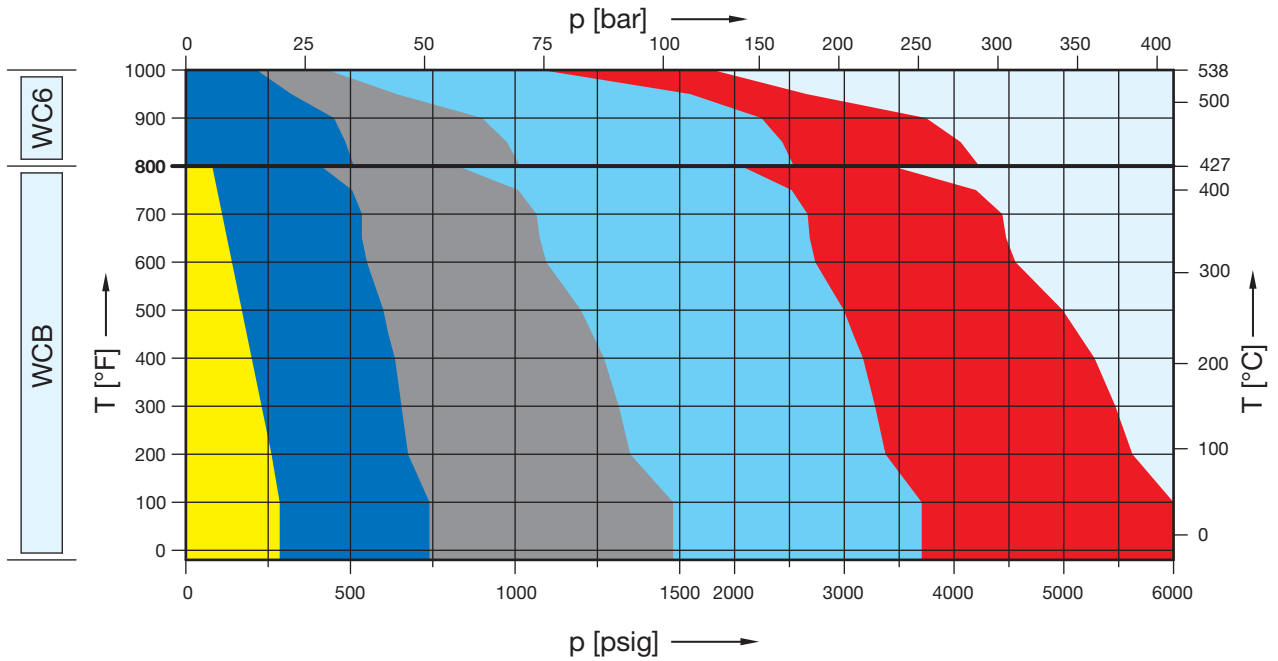

	150 x 150	300L x 150	300 x 150	600 x 150	900 x 300	1500 x 300	2500 x 300
CF8M	5264.010X	See 300 x 150	5264.011X	5264.012X	See 1500 x 300	5264.013X	5264.014X

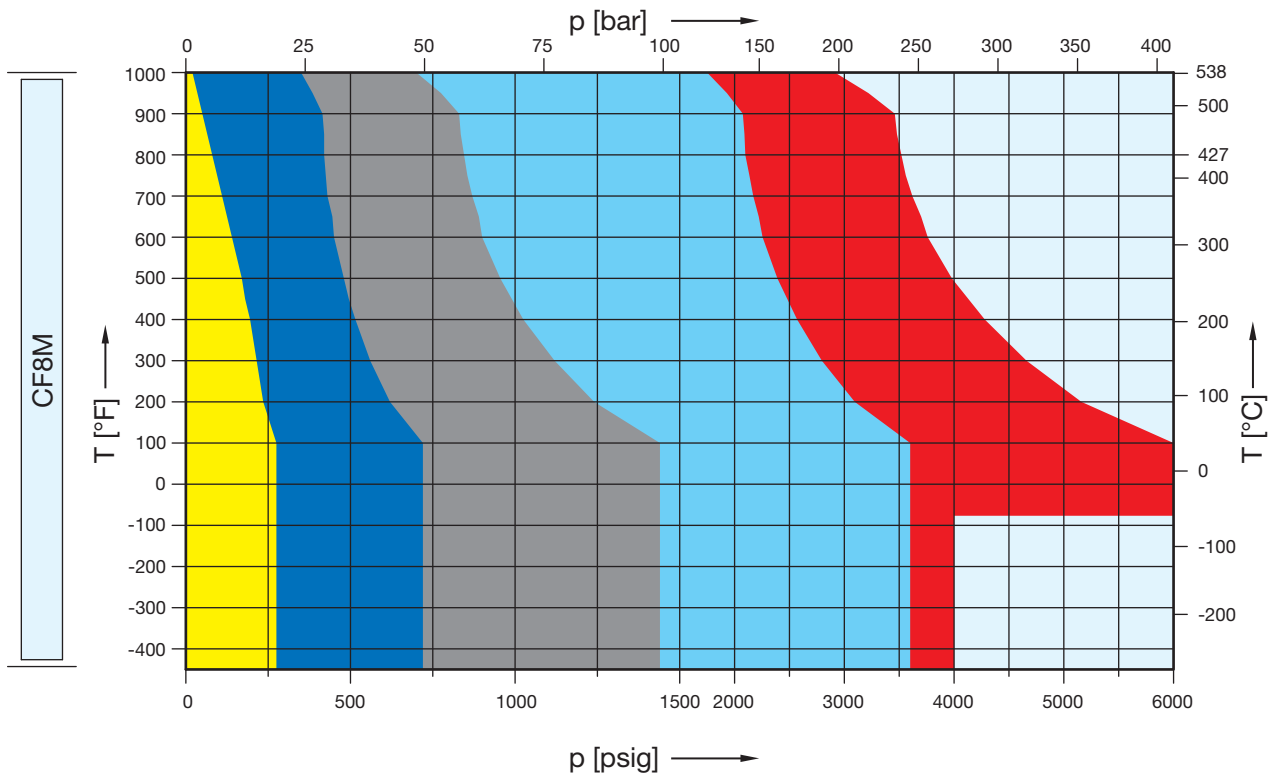

## Article numbers, dimensions and weights

### Article numbers

Valve size	1 D 2	1 D 2	1 D 2	1 D 2	1 1/2 D 2	1 1/2 D 2	1 1/2 D 3
Flange rating class <small>Inlet x Outlet</small>	150 x 150	300L x 150	300 x 150	600 x 150	900 x 300	1500 x 300	2500 x 300
Actual Orifice diameter $d_0$ [mm]	14.0	14.0	14.0	14.0	14.0	14.0	14.0
Actual Orifice area $A_0$ [mm <sup>2</sup> ]	154	154	154	154	154	154	154

### Body material

WCB 1.0619	Art.-No.	5262.001 <sup>□</sup>	Use 1 D 2 300 x 150	5262.002 <sup>□</sup>	5262.003 <sup>□</sup>	Use 1 1/2 D 2 1500 x 300	5262.004 <sup>□</sup>	5262.005 <sup>□</sup>
CF8M 1.4408	Art.-No.	5264.010 <sup>□</sup>		5264.011 <sup>□</sup>	5264.012 <sup>□</sup>		5264.013 <sup>□</sup>	5264.014 <sup>□</sup>
WC6 1.7357	Art.-No.	-		5267.006 <sup>□</sup>	5267.007 <sup>□</sup>		5267.008 <sup>□</sup>	5267.009 <sup>□</sup>
LCB	Art.-No.	5263.500 <sup>□</sup>		5263.501 <sup>□</sup>	5263.502 <sup>□</sup>		5263.503 <sup>□</sup>	5263.504 <sup>□</sup>

<sup>□</sup> Please add code for the required cap or lifting device. See below.

### Dimensions and weights

#### Metric Units

<b>Weight</b>		17.3		17.3	17.3		31.1	41.8
[kg]	with bellows	18.4	Use 1 D 2 300 x 150	18.4	18.4	Use 1 1/2 D 2 1500 x 300	33.1	44.6
<b>Center to face</b>	Inlet a	105		105	105		105	140
[mm]	Outlet b	114		114	114		140	178
	s	30		30	30		44	57
<b>Height (H4)</b>	Standard H max.	440		440	440		517	576
[mm]	Bellows H max.	465	465	465	542	576		
<b>Support brackets</b>	A	130	130	130	162	162		
[mm]	B	-	-	-	-	-		
	C	Ø 14	Ø 14	Ø 14	Ø 14	Ø 14		
	D	132	132	132	129	189		
	E	16	16	16	16	16		

#### US Units

<b>Weight</b>		38.1		38.1	38.1		68.6	92.2
[lbs]	with bellows	40.5	Use 1 D 2 300 x 150	40.5	40.5	Use 1 1/2 D 2 1500 x 300	73	98.4
<b>Center to face</b>	Inlet a	4 1/8		4 1/8	4 1/8		4 1/8	5 1/2
[inch]	Outlet b	4 1/2		4 1/2	4 1/2		5 1/2	7
	s	1 3/16		1 3/16	1 3/16		1 3/4	2 1/4
<b>Height (H4)</b>	Standard H max.	17 5/16		17 5/16	17 5/16		20 11/32	22 11/16
[inch]	Bellows H max.	18 5/16	18 5/16	18 5/16	21 11/32	22 11/16		
<b>Support brackets</b>	A	5 1/8	5 1/8	5 1/8	6 3/8	6 3/8		
[inch]	B	-	-	-	-	-		
	C	Ø 9/16	Ø 9/16	Ø 9/16	Ø 9/16	Ø 9/16		
	D	5 7/32	5 7/32	5 7/32	5 7/32	7 15/32		
	E	5/8	5/8	5/8	5/8	5/8		

#### Code for lifting device

Lifting device	H2	H3	H4	H3
Bonnet	closed	closed	closed	open
WCB 1.0619, WC6 1.7357, LCB	2	3	4	5
CF8M 1.4408	2	-	4	-

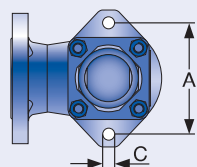

Support brackets

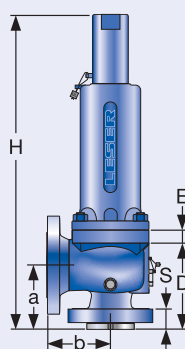

Conventional design

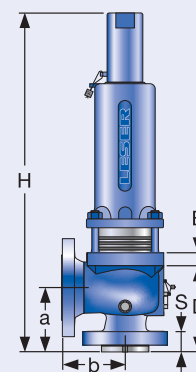

Balanced bellows design

## Pressure temperature ratings

### Metric Units

Valve size	1 D 2	1 D 2	1 D 2	1 D 2	1 1/2 D 2	1 1/2 D 2	1 1/2 D 3	
Flange rating class <small>Inlet x Outlet</small>	150 x 150	300L x 150	300 x 150	600 x 150	900 x 300	1500 x 300	2500 x 300	
Actual Orifice diameter $d_0$ [mm]	14.0	14.0	14.0	14.0	14.0	14.0	14.0	
Actual Orifice area $A_0$ [mm <sup>2</sup> ]	154	154	154	154	154	154	154	
Minimum set pressure [bar] S/G/L	0.3	0.3	0.3	0.3	5.0	5.0	18.5	
Minimum set pressure [bar] S/G	3.5	3.5	3.5	11.0	24.0	24.0	24.0	
Balanced bellows Inconel [bar] L	3.5	3.5	3.5	11.0	11.0	11.0	11.0	
<b>Body material: WCB 1.0619</b>		<b>Pressure range p [bar] S/G/L</b>						
<b>Maximum set pressure</b>	-29 to 38 °C	19.7	Use 1 D 2 300 x 150	51.0	102.1	Use 1 1/2 D 2 1500 x 300	255.5	413.8
	39 to 232 °C	12.8		42.4	85.2		212.4	354.1
	233 to 427 °C	5.5		28.3	56.9		142.1	236.6
<b>Outlet pressure limit</b> Conventional design		19.7		19.7	19.7		41.4	51.0
<b>Outlet pressure limit</b> Balanced bellows design		15.9		15.9	15.9		34.5	34.5
<b>Body material: CF8M 1.4408</b>		<b>Pressure range p [bar] S/G/L</b>						
<b>Maximum set pressure</b>	-268 to -60 °C	19.0	Use 1 D 2 300 x 150	49.7	99.3	Use 1 1/2 D 2 1500 x 300	248.3	275.9
	-59 to -29 °C	19.0		49.7	99.3		248.3	413.8
	-28 to 38 °C	19.0		49.7	99.3		248.3	413.8
	39 to 232 °C	12.4		34.1	68.3		171.0	284.8
	233 to 427 °C	5.5		29.0	58.3		145.5	242.8
428 to 538 °C	1.4	24.1	48.3	120.7	201.0			
<b>Outlet pressure limit</b> Conventional design		19.0		19.0	19.0		41.4	49.7
<b>Outlet pressure limit</b> Balanced bellows design		15.9		15.9	15.9		34.5	34.5
<b>Body material: WC6 1.7357</b>		<b>Pressure range p [bar] S/G/L</b>						
<b>Maximum set pressure</b>	233 to 427 °C	–	–	35.2	70.0	Use 1 1/2 D 2 1500 x 300	175.2	291.7
	428 to 538 °C	–	–	14.8	29.7		74.5	124.1
<b>Outlet pressure limit</b> Conventional design		–	–	19.7	19.7		41.4	51.0
<b>Outlet pressure limit</b> Balanced bellows design		–	–	15.9	15.9		34.5	34.5
<b>Body material: LCB</b>		<b>Pressure range p [bar] S/G/L</b>						
<b>Maximum set pressure</b>	-46 to 38 °C	18.4	Use 1 D 2 300 x 150	48.0	96.0	Use 1 1/2 D 2 1500 x 300	240.1	400.1
	39 to 200 °C	13.8		42.5	85.1		212.7	354.4
	201 to 343 °C	8.4		36.4	72.8		182.0	303.3
<b>Outlet pressure limit</b> Conventional design		18.4		18.4	18.4		41.4	48.0
<b>Outlet pressure limit</b> Balanced bellows design		15.9		15.9	15.9		34.5	34.5

Remark: SA 352 Gr. LCB is not listed in the API 526. Pressure-Temperature Rating acc. to ASME B16.34 Table 2-1.3  
The stated Pressure-Temperature Rating are taken from ASME B16.34 Table 2-1.3 if the maximum pressure is not limited by API 526.

Due to the extended material test certificate the LESER LCB can be applied as LCC, WCB, WCC and 1.0619 with the respective pressure-temperature range as well.

## Pressure temperature ratings

US Units								
Valve size		1 D 2	1 D 2	1 D 2	1 D 2	1 1/2 D 2	1 1/2 D 2	1 1/2 D 3
Flange rating class <small>Inlet x Outlet</small>		150 x 150	300L x 150	300 x 150	600 x 150	900 x 300	1500 x 300	2500 x 300
Actual Orifice diameter $d_0$ [inch]		0.551	0.551	0.551	0.551	0.551	0.551	0.551
Actual Orifice area $A_0$ [inch <sup>2</sup> ]		0.239	0.239	0.239	0.239	0.239	0.239	0.239
Minimum set pressure [psig] S/G/L		4.0	4.0	4.0	4.0	73.0	73.0	268.0
Minimum set pressure [psig] S/G		50.8	50.8	50.8	159.5	348.0	348.0	348.0
Balanced bellows Inconel [psig] L		50.8	50.8	50.8	159.5	159.5	159.5	159.5
<b>Body material: WCB 1.0619</b>		<b>Pressure range p [psig] S/G/L</b>						
<b>Maximum set pressure</b>	-20 to 100 °F	285	Use 1 D 2 300 x 150	740	1480	Use 1 1/2 D 2 1500 x 300	3705	6000
	101 to 450 °F	185		615	1235		3080	5135
	451 to 800 °F	80		410	825		2060	3430
<b>Outlet pressure limit</b> Conventional design		285		285	285		600	740
<b>Outlet pressure limit</b> Balanced bellows design		230		230	230		500	500
<b>Body material: CF8M 1.4408</b>		<b>Pressure range p [psig] S/G/L</b>						
<b>Maximum set pressure</b>	-450 to -76 °F	275	Use 1 D 2 300 x 150	720	1440	Use 1 1/2 D 2 1500 x 300	3600	4000
	-75 to -21 °F	275		720	1440		3600	6000
	-20 to 100 °F	275		720	1440		3600	6000
	101 to 450 °F	180		495	990		2480	4130
	451 to 800 °F	80		420	845		2110	3520
801 to 1000 °F	20	350	700	1750	2915			
<b>Outlet pressure limit</b> Conventional design		275		275	275		600	720
<b>Outlet pressure limit</b> Balanced bellows design		230		230	230		500	500
<b>Body material: WC6 1.7357</b>		<b>Pressure range p [psig] S/G/L</b>						
<b>Maximum set pressure</b>	451 to 800 °F	–	–	510	1015	Use 1 1/2 D 2 1500 x 300	2540	4230
	801 to 1000 °F	–	–	215	430		1080	1800
<b>Outlet pressure limit</b> Conventional design		–	–	285	285		600	740
<b>Outlet pressure limit</b> Balanced bellows design		–	–	230	230		500	500
<b>Body material: LCB</b>		<b>Pressure range p [psig] S/G/L</b>						
<b>Maximum set pressure</b>	-50 to 100 °F	265	Use 1 D 2 300 x 150	695	1395	Use 1 1/2 D 2 1500 x 300	3480	5805
	101 to 400 °F	200		615	1230		3075	5125
	401 to 650 °F	125		535	1065		2665	3430
<b>Outlet pressure limit</b> Conventional design		265		265	265		600	695
<b>Outlet pressure limit</b> Balanced bellows design		230		230	230		500	500

Remark: SA 352 Gr. LCB is not listed in the API 526. Pressure-Temperature Rating acc. to ASME B16.34 Table 2-1.3  
The stated Pressure-Temperature Rating are taken from ASME B16.34 Table 2-1.3 if the maximum pressure is not limited by API 526.

Due to the extended material test certificate the LESER LCB can be applied as LCC, WCB, WCC and 1.0619 with the respective pressure-temperature range as well.



## Selection chart

	150 x 150	300L x 150	300 x 150	600 x 150	900 x 300	1500 x 300	2500 x 300
WCB	5262.015X	See 300 x 150	5262.016X	5262.017X	See 1500 x 300	5262.018X	5262.019X
WC6	-	See 300 x 150	5267.020X	5267.021X	See 1500 x 300	5267.022X	5267.023X

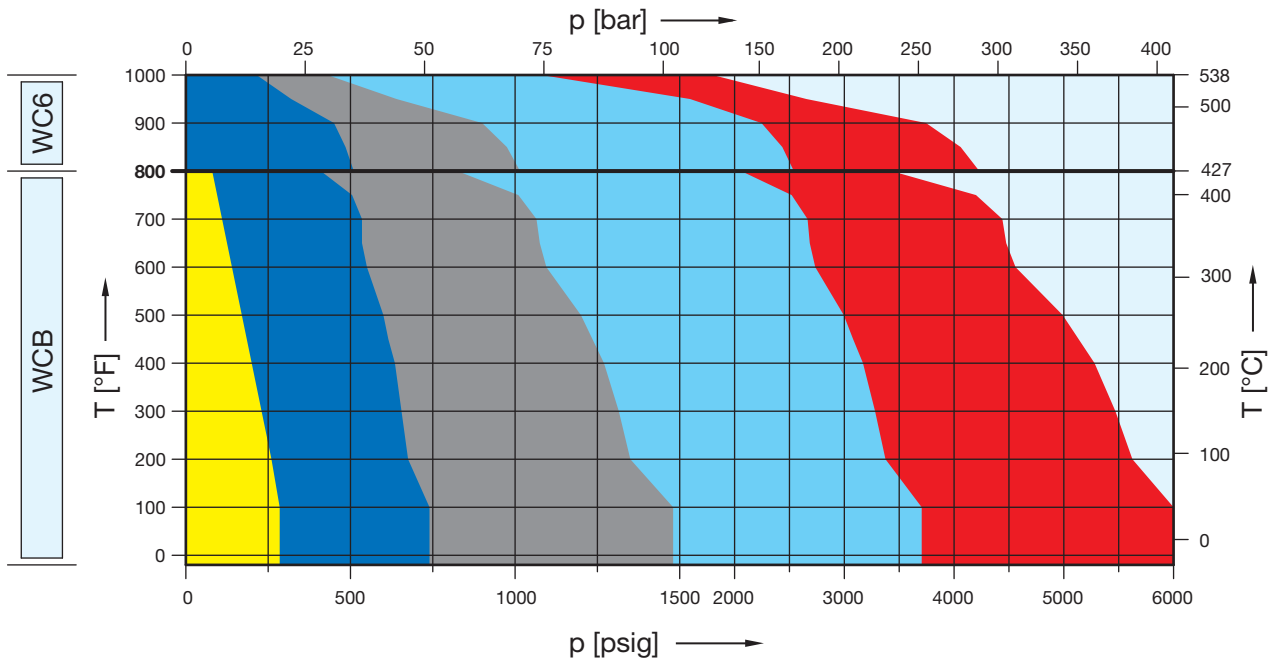

	150 x 150	300L x 150	300 x 150	600 x 150	900 x 300	1500 x 300	2500 x 300
CF8M	5264.024X	See 300 x 150	5264.025X	5264.026X	See 1500 x 300	5264.027X	5264.028X

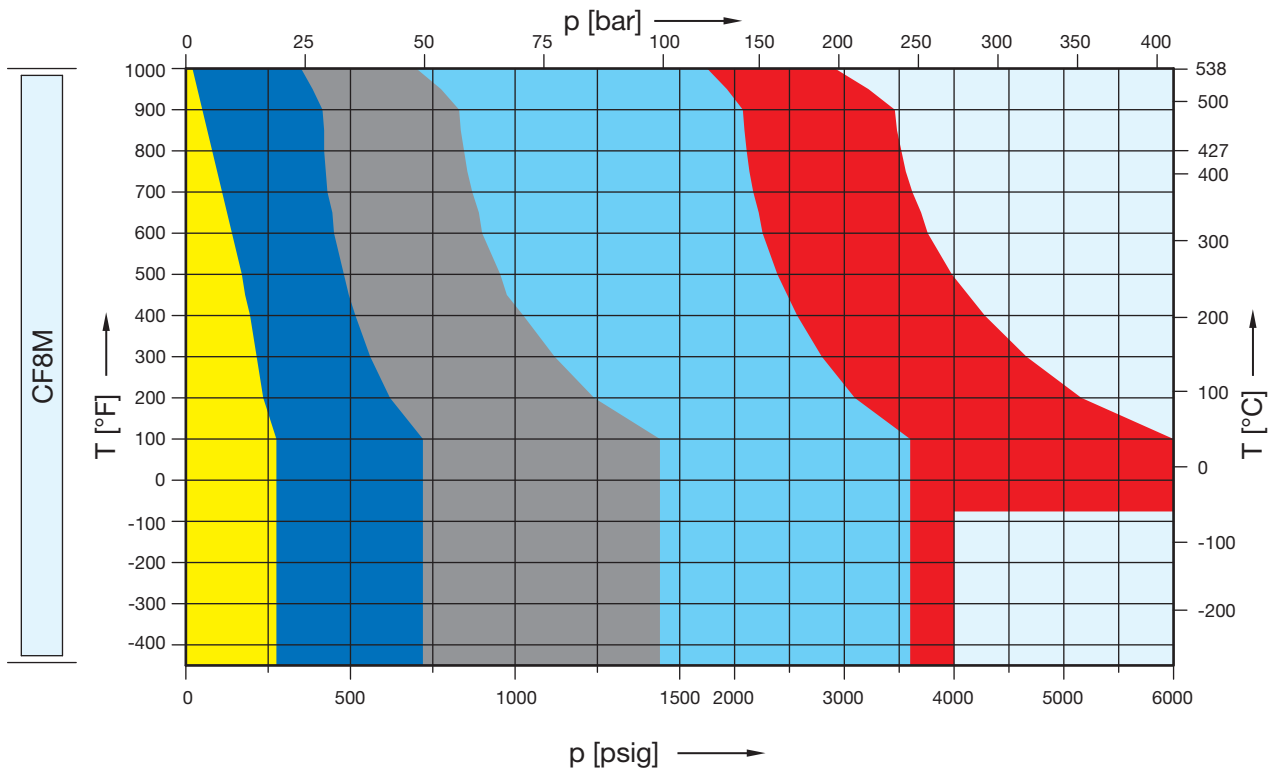

## Article numbers, dimensions and weights

### Article numbers

Valve size	1 E 2	1 E 2	1 E 2	1 E 2	1 1/2 E 2	1 1/2 E 2	1 1/2 E 3
Flange rating class <small>Inlet x Outlet</small>	150 x 150	300L x 150	300 x 150	600 x 150	900 x 300	1500 x 300	2500 x 300
Actual Orifice diameter $d_0$ [mm]	14.0	14.0	14.0	14.0	14.0	14.0	14.0
Actual Orifice area $A_0$ [mm <sup>2</sup> ]	154	154	154	154	154	154	154

### Body material

WCB 1.0619	Art.-No.	5262.015 <sup>□</sup>	Use 1 E 2 300 x 150	5262.016 <sup>□</sup>	5262.017 <sup>□</sup>	Use 1 1/2 E 2 1500 x 300	5262.018 <sup>□</sup>	5262.019 <sup>□</sup>
CF8M 1.4408	Art.-No.	5264.024 <sup>□</sup>		5264.025 <sup>□</sup>	5264.026 <sup>□</sup>		5264.027 <sup>□</sup>	5264.028 <sup>□</sup>
WC6 1.7357	Art.-No.	-		5267.020 <sup>□</sup>	5267.021 <sup>□</sup>		5267.022 <sup>□</sup>	5267.023 <sup>□</sup>
LCB	Art.-No.	5263.505 <sup>□</sup>		5263.506 <sup>□</sup>	5263.507 <sup>□</sup>		5263.508 <sup>□</sup>	5263.509 <sup>□</sup>

<sup>□</sup> Please add code for the required cap or lifting device. See below.

### Dimensions and weights

#### Metric Units

<b>Weight</b> [kg]		17.3		17.3	17.3		31.1	41.8	
	with bellows	18.4	Use 1 E 2 300 x 150	18.4	18.4	Use 1 1/2 E 2 1500 x 300	33.1	44.6	
<b>Center to face</b> [mm]	Inlet a	105		105	105		105	140	140
	Outlet b	114		114	114		114	178	178
	s	30		30	30		30	57	57
<b>Height (H4)</b> [mm]	Standard H max.	440	440	440	440	517	576		
	Bellows H max.	465	465	465	465	542	576		
<b>Support brackets</b> [mm]	A	130	130	130	130	162	162		
	B	-	-	-	-	-	-		
	C	∅ 14	∅ 14	∅ 14	∅ 14	∅ 14	∅ 14		
	D	132	132	132	132	129	189		
	E	16	16	16	16	16	16		

#### US Units

<b>Weight</b> [lbs]		38.1		38.1	38.1		68.6	92.2	
	with bellows	40.5	Use 1 E 2 300 x 150	40.5	40.5	Use 1 1/2 E 2 1500 x 300	73	98.4	
<b>Center to face</b> [inch]	Inlet a	4 1/8		4 1/8	4 1/8		4 1/8	5 1/2	5 1/2
	Outlet b	4 1/2		4 1/2	4 1/2		4 1/2	7	7
	s	1 3/16		1 3/16	1 3/16		1 3/16	2 1/4	2 1/4
<b>Height (H4)</b> [inch]	Standard H max.	17 5/16	17 5/16	17 5/16	17 5/16	20 11/32	22 11/16		
	Bellows H max.	18 5/16	18 5/16	18 5/16	18 5/16	21 11/32	22 11/16		
<b>Support brackets</b> [inch]	A	5 1/8	5 1/8	5 1/8	5 1/8	6 3/8	6 3/8		
	B	-	-	-	-	-	-		
	C	∅ 9/16	∅ 9/16	∅ 9/16	∅ 9/16	∅ 9/16	∅ 9/16		
	D	5 7/32	5 7/32	5 7/32	5 7/32	7 15/32	7 15/32		
	E	5/8	5/8	5/8	5/8	5/8	5/8		

#### Code for lifting device

Lifting device	H2	H3	H4	H3
Bonnet	closed	closed	closed	open
WCB 1.0619, WC6 1.7357, LCB	2	3	4	5
CF8M 1.4408	2	-	4	-

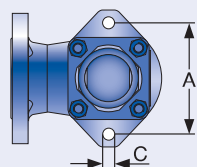

Support brackets

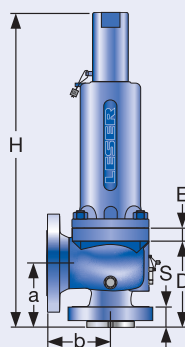

Conventional design

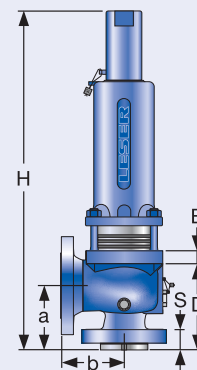

Balanced bellows design

## Pressure temperature ratings

### Metric Units

Valve size	1 E 2	1 E 2	1 E 2	1 E 2	1 1/2 E 2	1 1/2 E 2	1 1/2 E 3	
Flange rating class <small>Inlet x Outlet</small>	150 x 150	300L x 150	300 x 150	600 x 150	900 x 300	1500 x 300	2500 x 300	
Actual Orifice diameter $d_0$ [mm]	14.0	14.0	14.0	14.0	14.0	14.0	14.0	
Actual Orifice area $A_0$ [mm <sup>2</sup> ]	154	154	154	154	154	154	154	
Minimum set pressure [bar] S/G/L	0.3	0.3	0.3	0.3	5.0	5.0	18.5	
Minimum set pressure [bar] S/G	3.5	3.5	3.5	11.0	24.0	24.0	24.0	
Balanced bellows Inconel [bar] L	3.5	3.5	3.5	11.0	11.0	11.0	11.0	
<b>Body material: WCB 1.0619</b>								
<b>Pressure range p [bar] S/G/L</b>								
<b>Maximum set pressure</b>	-29 to 38 °C	19.7	Use 1 E 2 300 x 150	51.0	102.1	Use 1 1/2 E 2 1500 x 300	255.5	413.8
	39 to 232 °C	12.8		42.4	85.2		212.4	354.1
	233 to 427 °C	5.5		28.3	56.9		142.1	236.6
<b>Outlet pressure limit</b> Conventional design		19.7		19.7	19.7		41.4	51.0
<b>Outlet pressure limit</b> Balanced bellows design		15.9		15.9	15.9		34.5	34.5
<b>Body material: CF8M 1.4408</b>								
<b>Pressure range p [bar] S/G/L</b>								
<b>Maximum set pressure</b>	-268 to -60 °C	19.0	Use 1 E 2 300 x 150	49.7	99.3	Use 1 1/2 E 2 1500 x 300	248.3	275.9
	-59 to -29 °C	19.0		49.7	99.3		248.3	413.8
	-28 to 38 °C	19.0		49.7	99.3		248.3	413.8
	39 to 232 °C	12.4		34.1	67.2		171.0	284.8
	233 to 427 °C	5.5		29.0	58.3		145.5	242.8
428 to 538 °C	1.4	24.1	48.3	120.7	201.0			
<b>Outlet pressure limit</b> Conventional design		19.0		19.0	19.0		41.4	49.7
<b>Outlet pressure limit</b> Balanced bellows design		15.9		15.9	15.9		34.5	34.5
<b>Body material: WC6 1.7357</b>								
<b>Pressure range p [bar] S/G/L</b>								
<b>Maximum set pressure</b>	233 to 427 °C	-	-	35.2	70.0	Use 1 1/2 E 2 1500 x 300	175.2	291.7
	428 to 538 °C	-	-	14.8	29.7		74.5	124.1
<b>Outlet pressure limit</b> Conventional design		-	-	19.7	19.7		41.4	51.0
<b>Outlet pressure limit</b> Balanced bellows design		-	-	15.9	15.9		34.5	34.5
<b>Body material: LCB</b>								
<b>Pressure range p [bar] S/G/L</b>								
<b>Maximum set pressure</b>	-46 to 38 °C	18.4	Use 1 E 2 300 x 150	48.0	96.0	Use 1 1/2 E 2 1500 x 300	240.1	400.1
	39 to 200 °C	13.8		42.5	85.1		212.7	354.4
	201 to 343 °C	8.4		36.4	72.8		182.0	303.3
<b>Outlet pressure limit</b> Conventional design		18.4		18.4	18.4		41.4	48.0
<b>Outlet pressure limit</b> Balanced bellows design		15.9		15.9	15.9		34.5	34.5

Remark: SA 352 Gr. LCB is not listed in the API 526. Pressure-Temperature Rating acc. to ASME B16.34 Table 2-1.3  
The stated Pressure-Temperature Rating are taken from ASME B16.34 Table 2-1.3 if the maximum pressure is not limited by API 526.

Due to the extended material test certificate the LESER LCB can be applied as LCC, WCB, WCC and 1.0619 with the respective pressure-temperature range as well.

## Pressure temperature ratings

US Units								
Valve size		1 E 2	1 E 2	1 E 2	1 E 2	1 1/2 E 2	1 1/2 E 2	1 1/2 E 3
Flange rating class <small>Inlet x Outlet</small>		150 x 150	300L x 150	300 x 150	600 x 150	900 x 300	1500 x 300	2500 x 300
Actual Orifice diameter $d_0$ [inch]		0.551	0.551	0.551	0.551	0.551	0.551	0.551
Actual Orifice area $A_0$ [inch <sup>2</sup> ]		0.239	0.239	0.239	0.239	0.239	0.239	0.239
Minimum set pressure [psig] S/G/L		4.0	4.0	4.0	4.0	73.0	73.0	268.0
Minimum set pressure [psig] S/G		50.8	50.8	50.8	159.5	348.0	348.0	348.0
Balanced bellows Inconel [psig] L		50.8	50.8	50.8	159.5	159.5	159.5	159.5
<b>Body material: WCB 1.0619</b>		<b>Pressure range p [psig] S/G/L</b>						
<b>Maximum set pressure</b>	-20 to 100 °F	285	Use 1 E 2 300 x 150	740	1480	Use 1 1/2 E 2 1500 x 300	3705	6000
	101 to 450 °F	185		615	1235		3080	5135
	451 to 800 °F	80		410	825		2060	3430
<b>Outlet pressure limit</b> Conventional design		285		285	285		600	740
<b>Outlet pressure limit</b> Balanced bellows design		230		230	230		500	500
<b>Body material: CF8M 1.4408</b>		<b>Pressure range p [psig] S/G/L</b>						
<b>Maximum set pressure</b>	-450 to -76 °F	275	Use 1 E 2 300 x 150	720	1440	Use 1 1/2 E 2 1500 x 300	3600	4000
	-75 to -21 °F	275		720	1440		3600	6000
	-20 to 100 °F	275		720	1440		3600	6000
	101 to 450 °F	180		495	975		2480	4130
	451 to 800 °F	80		420	845		2110	3520
801 to 1000 °F	20	350	700	1750	2915			
<b>Outlet pressure limit</b> Conventional design		275		275	275		600	720
<b>Outlet pressure limit</b> Balanced bellows design		230		230	230		500	500
<b>Body material: WC6 1.7357</b>		<b>Pressure range p [psig] S/G/L</b>						
<b>Maximum set pressure</b>	451 to 800 °F	-	-	510	1015	Use 1 1/2 E 2 1500 x 300	2540	4230
	801 to 1000 °F	-	-	215	430		1080	1800
<b>Outlet pressure limit</b> Conventional design		-	-	285	285		600	740
<b>Outlet pressure limit</b> Balanced bellows design		-	-	230	230		500	500
<b>Body material: LCB</b>		<b>Pressure range p [psig] S/G/L</b>						
<b>Maximum set pressure</b>	-50 to 100 °F	265	Use 1 E 2 300 x 150	695	1395	Use 1 1/2 E 2 1500 x 300	3480	5805
	101 to 400 °F	200		615	1230		3075	5125
	401 to 650 °F	125		535	1065		2665	4440
<b>Outlet pressure limit</b> Conventional design		265		265	265		600	695
<b>Outlet pressure limit</b> Balanced bellows design		230		230	230		500	500

Remark: SA 352 Gr. LCB is not listed in the API 526. Pressure-Temperature Rating acc. to ASME B16.34 Table 2-1.3  
The stated Pressure-Temperature Rating are taken from ASME B16.34 Table 2-1.3 if the maximum pressure is not limited by API 526.

Due to the extended material test certificate the LESER LCB can be applied as LCC, WCB, WCC and 1.0619 with the respective pressure-temperature range as well.

## Selection chart

	150 x 150	300L x 150	300 x 150	600 x 150	900 x 300	1500 x 300	2500 x 300
WCB	5262.029X	5262.030X	5262.031X	5262.032X	See 1500 x 300	5262.033X	5262.034X
WC6	-	-	5267.035X	5267.036X	See 1500 x 300	5267.037X	5267.038X

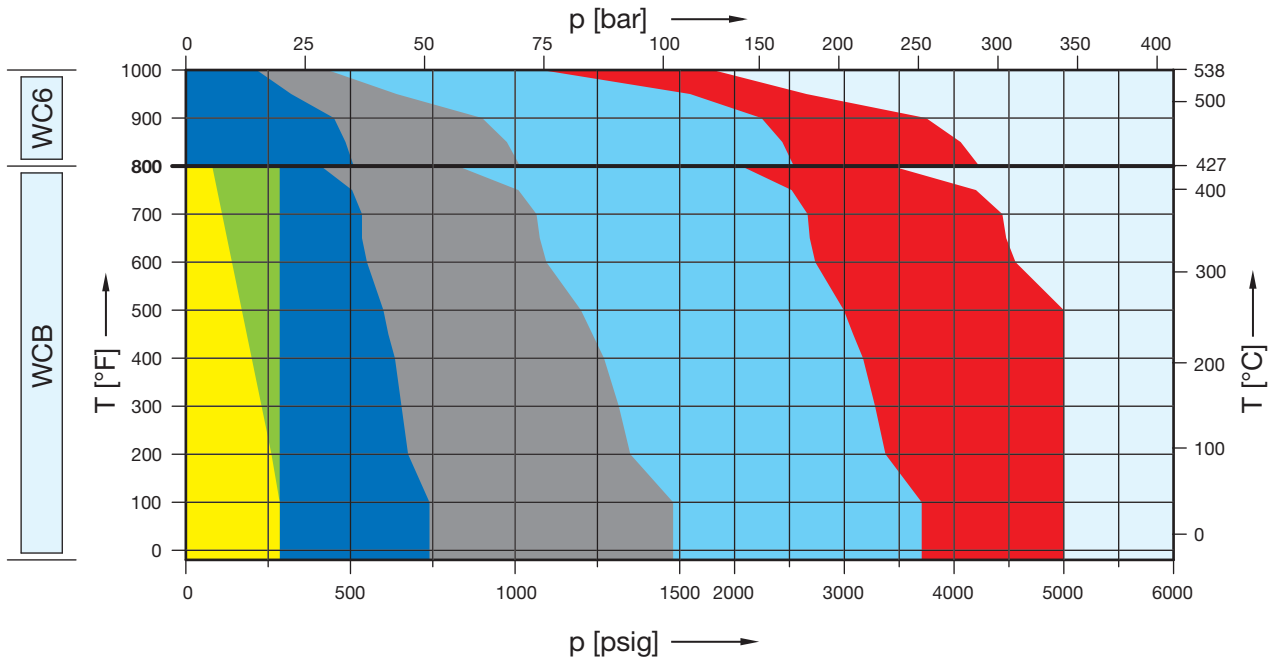

	150 x 150	300L x 150	300 x 150	600 x 150	900 x 300	1500 x 300	2500 x 300
CF8M	5264.039X	5264.040X	5264.041X	5264.042X	See 1500 x 300	5264.043X	5264.044X

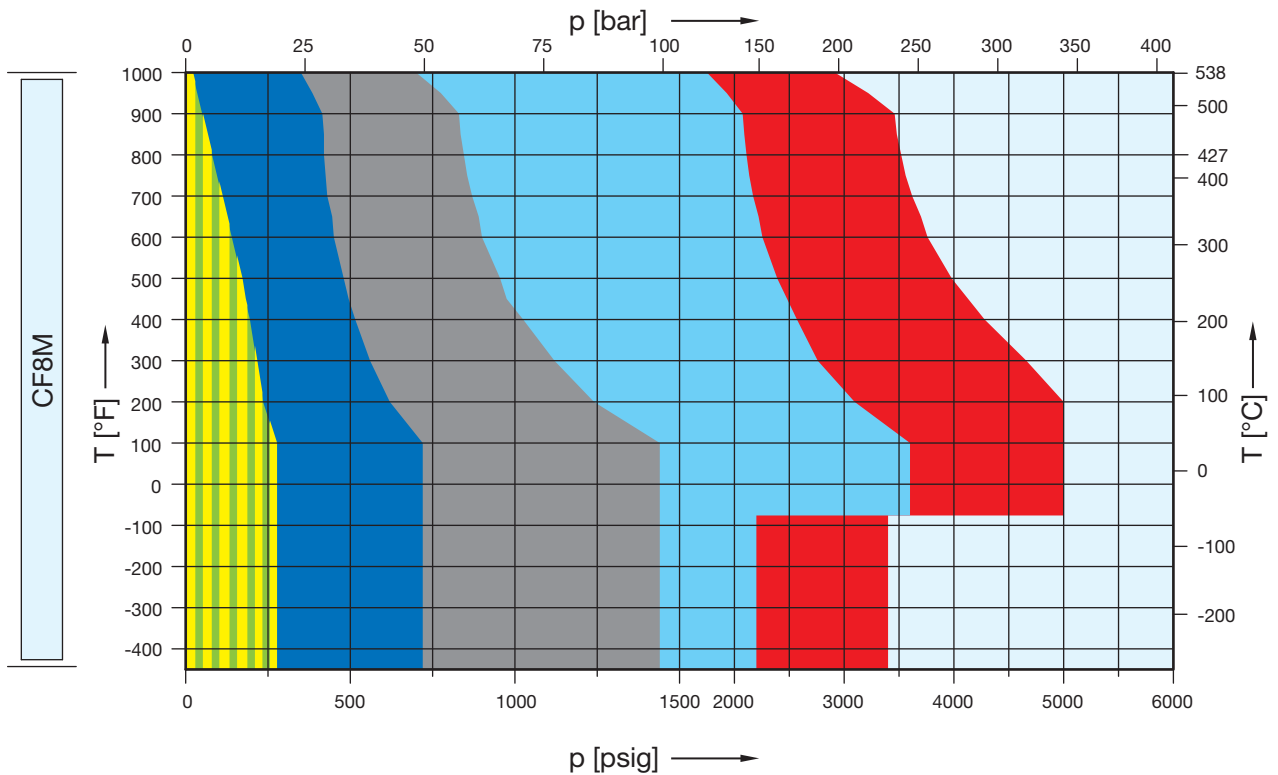

## Article numbers, dimensions and weights

### Article numbers

Valve size	1 1/2 F 2	1 1/2 F 2	1 1/2 F 2	1 1/2 F 2	1 1/2 F 3	1 1/2 F 3	1 1/2 F 3
Flange rating class <small>Inlet x Outlet</small>	150 x 150	300L x 150	300 x 150	600 x 150	900 x 300	1500 x 300	2500 x 300
Actual Orifice diameter $d_0$ [mm]	18.0	18.0	18.0	18.0	18.0	18.0	18.0
Actual Orifice area $A_0$ [mm <sup>2</sup> ]	254	254	254	254	254	254	254

### Body material

WCB 1.0619	Art.-No.	5262.029 <sup>□</sup>	5262.030 <sup>□</sup>	5262.031 <sup>□</sup>	5262.032 <sup>□</sup>	Use 1 1/2 F 3 1500 x 300	5262.033 <sup>□</sup>	5262.034 <sup>□</sup>
CF8M 1.4408	Art.-No.	5264.039 <sup>□</sup>	5264.040 <sup>□</sup>	5264.041 <sup>□</sup>	5264.042 <sup>□</sup>		5264.043 <sup>□</sup>	5264.044 <sup>□</sup>
WC6 1.7357	Art.-No.	-	-	5267.035 <sup>□</sup>	5267.036 <sup>□</sup>		5267.037 <sup>□</sup>	5267.038 <sup>□</sup>
LCB	Art.-No.	5263.510 <sup>□</sup>	5263.511 <sup>□</sup>	5263.512 <sup>□</sup>	5263.513 <sup>□</sup>		5263.514 <sup>□</sup>	5263.515 <sup>□</sup>

<sup>□</sup> Please add code for the required cap or lifting device. See below.

### Dimensions and weights

#### Metric Units

<b>Weight</b> [kg]		30.6	30.6	32.5	32.5	Use 1 1/2 F 3 1500 x 300	36.3	41.8
	with bellows	33.1	33.1	35	35		38.6	44.6
<b>Center to face</b> [mm]	Inlet a	124	124	124	124		124	140
	Outlet b	121	121	152	152		165	178
	s	32	32	35	35	44	57	
<b>Height (H4)</b> [mm]	Standard H max.	536	536	536	536	560	576	
	Bellows H max.	561	561	561	561	560	576	
<b>Support brackets</b> [mm]	A	162	162	162	162	162	162	
	B	-	-	-	-	-	-	
	C	Ø 14		Ø 14	Ø 14	Ø 14	Ø 14	
	D	148	148	148	148	174	189	
	E	16	16	16	16	16	16	

#### US Units

<b>Weight</b> [lbs]		67.5	67.5	71.1	71.1	Use 1 1/2 F 3 1500 x 300	80	92.2
	with bellows	73	73	77.2	77.2		85.1	98.4
<b>Center to face</b> [inch]	Inlet a	4 7/8	4 7/8	4 7/8	4 7/8		4 7/8	5 1/2
	Outlet b	4 3/4	4 3/4	6	6		6 1/2	7
	s	1 1/4	1 1/4	1 13/32	1 13/32	1 3/4	2 1/4	
<b>Height (H4)</b> [inch]	Standard H max.	21 3/32	21 3/32	21 3/32	21 3/32	22 1/16	22 11/16	
	Bellows H max.	22 3/32	22 3/32	22 3/32	22 3/32	22 1/16	22 11/16	
<b>Support brackets</b> [inch]	A	6 3/8	6 3/8	6 3/8	6 3/8	6 3/8	6 3/8	
	B	-	-	-	-	-	-	
	C	Ø 9/16	Ø 9/16	Ø 9/16	Ø 9/16	Ø 9/16	Ø 9/16	
	D	5 27/32	5 27/32	5 27/32	5 27/32	6 27/32	6 27/32	
	E	5/8	5/8	5/8	5/8	5/8	5/8	

#### Code for lifting device

Lifting device	H2	H3	H4	H3
Bonnet	closed	closed	closed	open
WCB 1.0619, WC6 1.7357, LCB	2	3	4	5
CF8M 1.4408	2	-	4	-

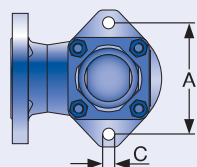

Support brackets

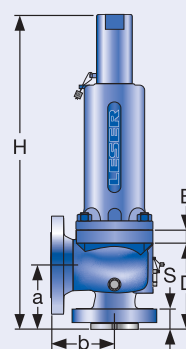

Conventional design

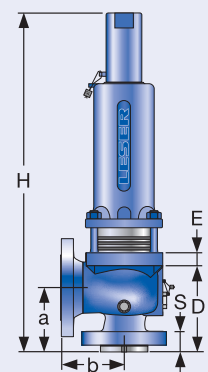

Balanced bellows design



## Pressure temperature ratings

Metric Units								
Valve size		1 1/2 F 2	1 1/2 F 2	1 1/2 F 2	1 1/2 F 2	1 1/2 F 3	1 1/2 F 3	1 1/2 F 3
Flange rating class <small>Inlet x Outlet</small>		150 x 150	300L x 150	300 x 150	600 x 150	900 x 300	1500 x 300	2500 x 300
Actual Orifice diameter $d_0$ [mm]		18.0	18.0	18.0	18.0	18.0	18.0	18.0
Actual Orifice area $A_0$ [mm <sup>2</sup> ]		254	254	254	254	254	254	254
Minimum set pressure [bar] S/G/L		0.3	0.3	0.3	0.3	0.3	0.3	0.3
Minimum set pressure [bar] S/G		1.7	1.7	1.7	12.0	12.0	12.0	13.5
Balanced bellows Inconel [bar] L		2.5	2.5	2.5	8.2	8.2	8.2	8.2
<b>Body material: WCB 1.0619</b>		<b>Pressure range p [bar] S/G/L</b>						
<b>Maximum set pressure</b>	-29 to 38 °C	19.7	19.7	51.0	102.1	Use 1 1/2 F 3 1500 x 300	255.5	344.8
	39 to 232 °C	12.8	19.7	42.4	85.2		212.4	344.8
	233 to 427 °C	5.5	19.7	28.3	56.9		142.1	236.6
<b>Outlet pressure limit</b> Conventional design		19.7	19.7	19.7	19.7		51.0	51.0
<b>Outlet pressure limit</b> Balanced bellows design		15.9	15.9	15.9	15.9		34.5	34.5
<b>Body material: CF8M 1.4408</b>		<b>Pressure range p [bar] S/G/L</b>						
<b>Maximum set pressure</b>	-268 to -60 °C	19.0	19.0	49.7	99.3	Use 1 1/2 F 3 1500 x 300	151.7	234.5
	-59 to -29 °C	19.0	19.0	49.7	99.3		248.3	344.8
	-28 to 38 °C	19.0	19.0	49.7	99.3		248.3	344.8
	39 to 232 °C	12.4	12.4	34.1	67.2		171.0	284.8
	233 to 427 °C	5.5	5.5	29.0	58.3		145.5	242.8
	428 to 538 °C	1.4	1.4	24.1	48.3		120.7	201.0
<b>Outlet pressure limit</b> Conventional design		19.0	19.0	19.0	19.0		41.4	49.7
<b>Outlet pressure limit</b> Balanced bellows design		15.9	15.9	15.9	15.9		34.5	34.5
<b>Body material: CF8M 1.4408</b>		<b>Pressure range p [bar] S/G/L</b>						
<b>Maximum set pressure</b>	233 to 427 °C	–	–	35.2	70.0	Use 1 1/2 F 3 1500 x 300	175.2	291.7
	428 to 538 °C	–	–	14.8	29.7		74.5	124.1
<b>Outlet pressure limit</b> Conventional design		–	–	19.7	19.7		51.0	51.0
<b>Outlet pressure limit</b> Balanced bellows design		–	–	15.9	15.9		34.5	34.5
<b>Body material: CF8M 1.4408</b>		<b>Pressure range p [bar] S/G/L</b>						
<b>Maximum set pressure</b>	-46 to 38 °C	18.4	18.4	48.0	96.0	Use 1 1/2 F 3 1500 x 300	240.1	400.1
	39 to 200 °C	13.8	13.8	42.5	85.1		212.7	354.4
	201 to 343 °C	8.4	8.4	36.4	72.8		182.0	303.3
<b>Outlet pressure limit</b> Conventional design		18.4	18.4	18.4	18.4		48.0	48.0
<b>Outlet pressure limit</b> Balanced bellows design		15.9	15.9	15.9	15.9		34.5	34.5

Remark: SA 352 Gr. LCB is not listed in the API 526. Pressure-Temperature Rating acc. to ASME B16.34 Table 2-1.3  
The stated Pressure-Temperature Rating are taken from ASME B16.34 Table 2-1.3 if the maximum pressure is not limited by API 526.

Due to the extended material test certificate the LESER LCB can be applied as LCC, WCB, WCC and 1.0619 with the respective pressure-temperature range as well.

## Pressure temperature ratings

US Units		Valve size	1 1/2 F 2	1 1/2 F 2	1 1/2 F 2	1 1/2 F 2	1 1/2 F 3	1 1/2 F 3	1 1/2 F 3
		Flange rating class <small>Inlet x Outlet</small>	150 x 150	300L x 150	300 x 150	600 x 150	900 x 300	1500 x 300	2500 x 300
		Actual Orifice diameter $d_0$ [inch]	0.709	0.709	0.709	0.709	0.709	0.709	0.709
		Actual Orifice area $A_0$ [inch <sup>2</sup> ]	0.394	0.394	0.394	0.394	0.394	0.394	0.394
		Minimum set pressure [psig] S/G/L	4.0	4.0	4.0	4.0	4.0	4.0	4.0
		Minimum set pressure [psig] S/G	24.6	24.6	24.6	174.0	174.0	174.0	159.0
		Balanced bellows Inconel [psig] L	36.3	36.3	36.3	118.9	118.9	118.9	118.9
<b>Body material: WCB 1.0619</b>		<b>Pressure range p [psig] S/G/L</b>							
<b>Maximum set pressure</b>	-20 to 100 °F	285	285	740	1480	Use 1 1/2 F 3 1500 x 300	3705	5000	
	101 to 450 °F	185	285	615	1235		3080	5000	
	451 to 800 °F	80	285	410	825		2060	3430	
<b>Outlet pressure limit</b> Conventional design		285	285	285	285		740	740	
<b>Outlet pressure limit</b> Balanced bellows design		230	230	230	230		500	500	
<b>Body material: CF8M 1.4408</b>		<b>Pressure range p [psig] S/G/L</b>							
<b>Maximum set pressure</b>	-450 to -76 °F	275	275	720	1440	Use 1 1/2 F 3 1500 x 300	2200	3400	
	-75 to -21 °F	275	275	720	1440		3600	5000	
	-20 to 100 °F	275	275	720	1440		3600	5000	
	101 to 450 °F	180	180	495	975		2480	4130	
	451 to 800 °F	80	80	420	845		2110	3520	
801 to 1000 °F	20	20	350	700	1750	2915			
<b>Outlet pressure limit</b> Conventional design		275	275	275	275		600	720	
<b>Outlet pressure limit</b> Balanced bellows design		230	230	230	230		500	500	
<b>Body material: CF8M 1.4408</b>		<b>Pressure range p [psig] S/G/L</b>							
<b>Maximum set pressure</b>	451 to 800 °F	-	-	510	1015	Use 1 1/2 F 3 1500 x 300	2540	4230	
	801 to 1000 °F	-	-	215	430		1080	1800	
<b>Outlet pressure limit</b> Conventional design		-	-	285	285		740	740	
<b>Outlet pressure limit</b> Balanced bellows design		-	-	230	230		500	500	
<b>Body material: LCB</b>		<b>Pressure range p [psig] S/G/L</b>							
<b>Maximum set pressure</b>	-50 to 100 °F	265	265	695	1395	Use 1 1/2 F 3 1500 x 300	3480	5805	
	101 to 400 °F	200	200	615	1230		3075	5125	
	401 to 650 °F	125	125	535	1065		2665	4440	
<b>Outlet pressure limit</b> Conventional design		265	265	265	265		695	695	
<b>Outlet pressure limit</b> Balanced bellows design		230	230	230	230		500	500	

Remark: SA 352 Gr. LCB is not listed in the API 526. Pressure-Temperature Rating acc. to ASME B16.34 Table 2-1.3  
The stated Pressure-Temperature Rating are taken from ASME B16.34 Table 2-1.3 if the maximum pressure is not limited by API 526.

Due to the extended material test certificate the LESER LCB can be applied as LCC, WCB, WCC and 1.0619 with the respective pressure-temperature range as well.

## Selection chart

	150 x 150	300L x 150	300 x 150	600 x 150	900 x 300	1500 x 300	2500 x 300
WC6	5262.045X	5262.046X	5262.047X	5262.048X	5262.049X	5262.050X	5262.051X
WC6	-	-	5267.052X	5267.053X	5267.054X	5267.055X	5267.056X

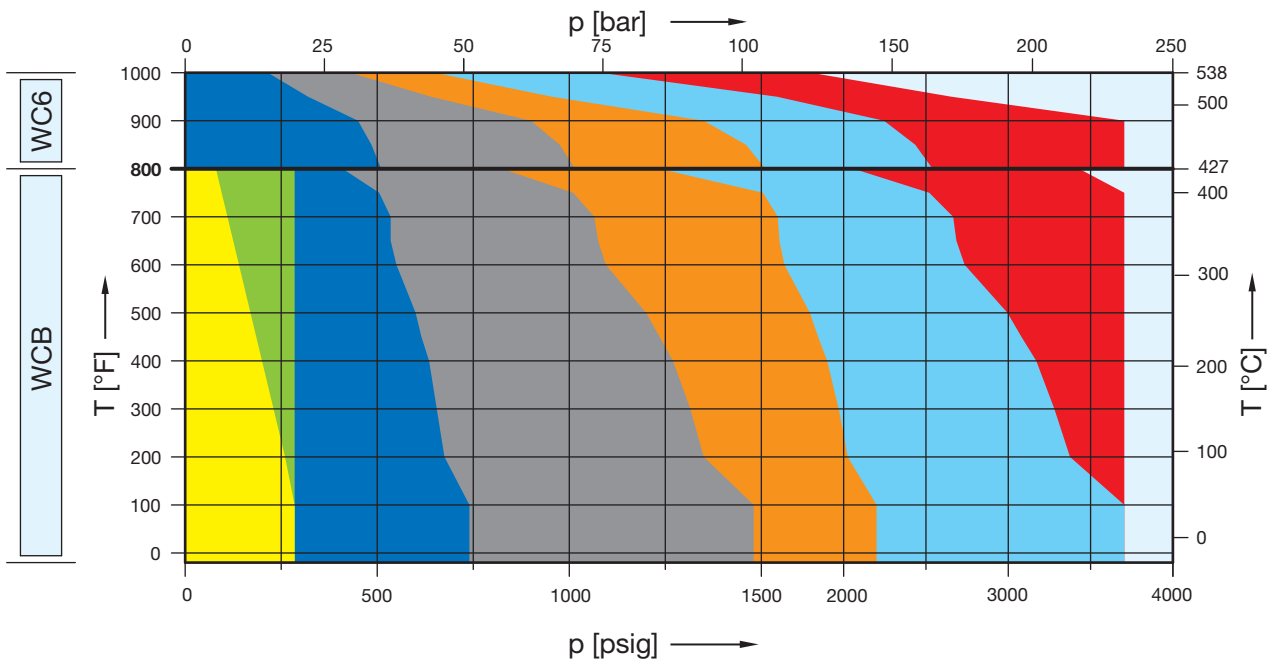

	150 x 150	300L x 150	300 x 150	600 x 150	900 x 300	1500 x 300	2500 x 300
CF8M	5264.110X	5264.111X	5264.112X	5264.113X	5264.114X	5264.115X	5264.116X

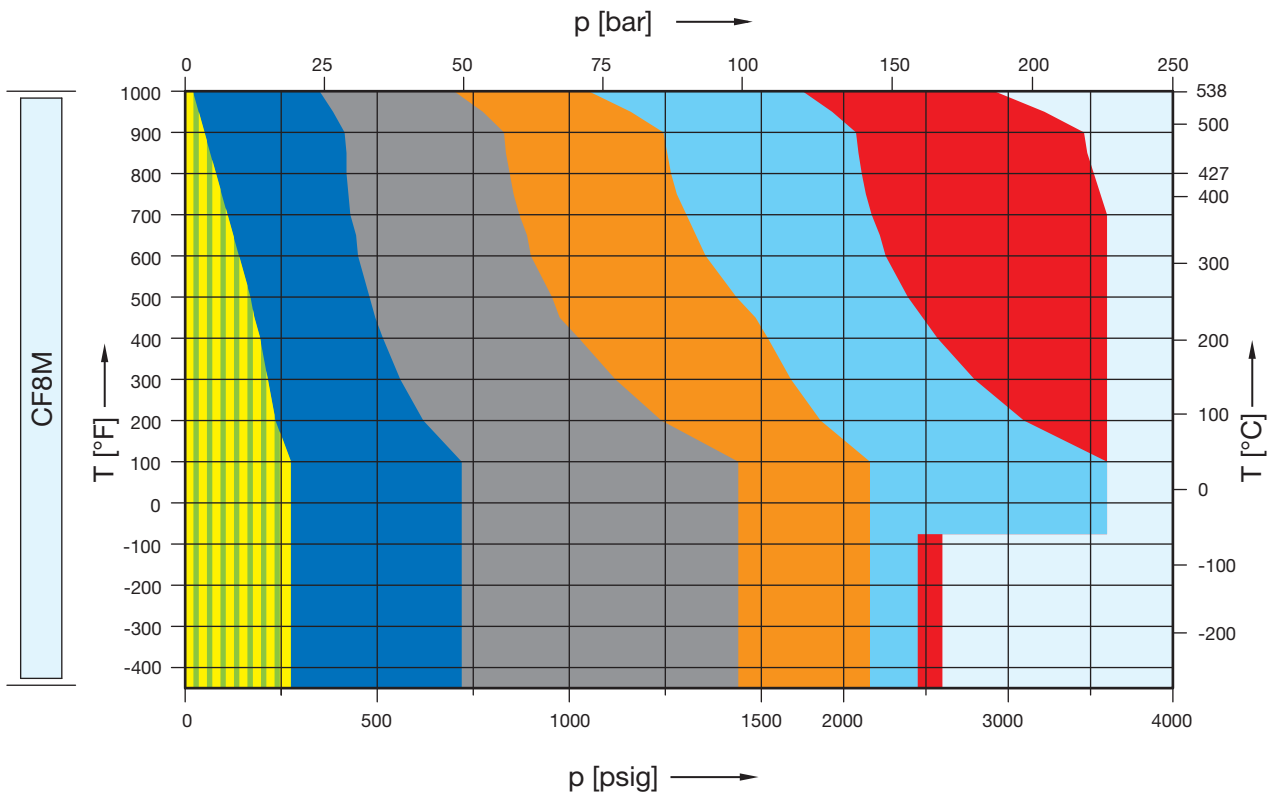

## Article numbers, dimensions and weights

### Article numbers

Valve size	1 1/2 G 3	1 1/2 G 3	1 1/2 G 3	1 1/2 G 3	1 1/2 G 3	2 G 3	2 G 3
Flange rating class <small>Inlet x Outlet</small>	150 x 150	300L x 150	300 x 150	600 x 150	900 x 300	1500 x 300	2500 x 300
Actual Orifice diameter $d_0$ [mm]	22.5	22.5	22.5	22.5	22.5	22.5	22.5
Actual Orifice area $A_0$ [mm <sup>2</sup> ]	398	398	398	398	398	398	398

### Body material

WCB 1.0619	Art.-No.	5262.045 <sup>□</sup>	5262.046 <sup>□</sup>	5262.047 <sup>□</sup>	5262.048 <sup>□</sup>	5262.049 <sup>□</sup>	5262.050 <sup>□</sup>	5262.051 <sup>□</sup>
CF8M 1.4408	Art.-No.	5264.110 <sup>□</sup>	5264.111 <sup>□</sup>	5264.112 <sup>□</sup>	5264.113 <sup>□</sup>	5264.114 <sup>□</sup>	5264.115 <sup>□</sup>	5264.116 <sup>□</sup>
WC6 1.7357	Art.-No.	-	-	5267.052 <sup>□</sup>	5267.053 <sup>□</sup>	5267.054 <sup>□</sup>	5267.055 <sup>□</sup>	5267.056 <sup>□</sup>
LCB	Art.-No.	5263.516 <sup>□</sup>	5263.517 <sup>□</sup>	5263.518 <sup>□</sup>	5263.519 <sup>□</sup>	5263.520 <sup>□</sup>	5263.521 <sup>□</sup>	5263.522 <sup>□</sup>

<sup>□</sup> Please add code for the required cap or lifting device. See below.

### Dimensions and weights

#### Metric Units

<b>Weight</b> [kg]		30,6	30,6	32,5	32,5	36,3	69,9	69,9
	with bellows	33,1	33,1	35	35	38,6	72,5	72,5
<b>Center to face</b> [mm]	Inlet a	124	124	124	124	124	156	156
	Outlet b	121	121	152	152	165	172	172
	s	32	32	35	35	44	68	68
<b>Height (H4)</b> [mm]	Standard H max.	536	536	536	536	560	688	688
	Bellows H max.	574	574	574	574	573	705	705
<b>Support brackets</b> [mm]	A	162	162	162	162	162	184	184
	B	-	-	-	-	-	110	110
	C	Ø 14	Ø 14	Ø 14	Ø 14	Ø 14	Ø 14	Ø 14
	D	148	148	148	148	174	198	198
	E	16	16	16	16	16	16	16

#### US Units

<b>Weight</b> [lbs]		67,5	67,5	71,7	71,7	80	154,1	154,1
	with bellows	73	73	77,2	77,2	85,1	159,9	159,9
<b>Center to face</b> [inch]	Inlet a	4 7/8	4 7/8	4 7/8	4 7/8	4 7/8	6 1/8	6 1/8
	Outlet b	4 3/4	4 3/4	6	6	6 1/2	6 3/4	6 3/4
	s	1 1/4	1 1/4	1 13/32	1 13/32	1 3/4	2 11/16	2 11/16
<b>Height (H4)</b> [inch]	Standard H max.	21 3/32	21 3/32	21 3/32	21 3/32	22 1/16	27 3/32	27 3/32
	Bellows H max.	22 19/32	22 19/32	22 19/32	22 19/32	22 9/16	27 3/4	27 3/4
<b>Support brackets</b> [inch]	A	6 3/8	6 3/8	6 3/8	6 3/8	6 3/8	7 1/4	7 1/4
	B	-	-	-	-	-	4 11/32	4 11/32
	C	Ø 9/16	Ø 9/16	Ø 9/16	Ø 9/16	Ø 9/16	Ø 9/16	Ø 9/16
	D	5 27/32	5 27/32	5 27/32	5 27/32	6 27/32	7 13/16	7 13/16
	E	5/8	5/8	5/8	5/8	5/8	5/8	5/8

#### Code for lifting device

Lifting device	H2	H3	H4	H3
Bonnet	closed	closed	closed	open
WCB 1.0619, WC6 1.7357, LCB	2	3	4	5
CF8M 1.4408	2	-	4	-

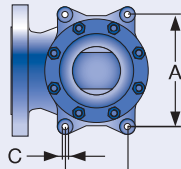
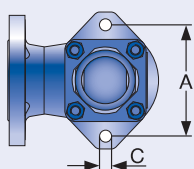

Support brackets

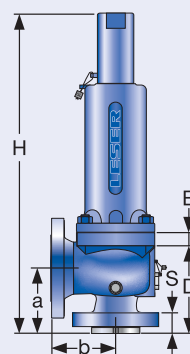

Conventional design

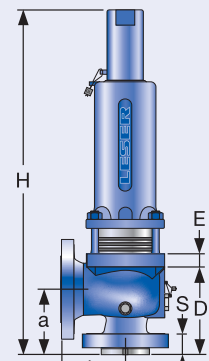

Balanced bellows design

## Pressure temperature ratings

Metric Units								
Valve size		1 1/2 G 3	1 1/2 G 3	1 1/2 G 3	1 1/2 G 3	1 1/2 G 3	2 G 3	2 G 3
Flange rating class <small>Inlet x Outlet</small>		150 x 150	300L x 150	300 x 150	600 x 150	900 x 300	1500 x 300	2500 x 300
Actual Orifice diameter $d_0$ [mm]		22.5	22.5	22,5	22.5	22.5	22.5	22.5
Actual Orifice area $A_0$ [mm <sup>2</sup> ]		398	398	398	398	398	398	398
Minimum set pressure [bar] S/G/L		0.2	0.2	0.2	0.2	0.2	5.0	5.0
Minimum set pressure [bar] S/G		3.4	3.4	3.4	9.2	9.2	9.2	9.2
Balanced bellows Inconel [bar] L		3.2	3.2	3.2	18.5	18.5	18.5	18.5
<b>Body material: WCB 1.0619</b>		<b>Pressure range p [bar] S/G/L</b>						
<b>Maximum set pressure</b>	-29 to 38 °C	19.7	19.7	51.0	102.1	153.1	255.5	255.5
	39 to 232 °C	12.8	19.7	42.4	85.2	127.2	212.4	255.5
	233 to 427 °C	5.5	19.7	28.3	56.9	85.2	142.1	236.6
<b>Outlet pressure limit</b> Conventional design		19.7	19.7	19.7	19.7	51.0	51.0	51.0
<b>Outlet pressure limit</b> Balanced bellows design		15.9	15.9	15.9	15.9	32.4	32.4	32.4
<b>Body material: CF8M 1.4408</b>		<b>Pressure range p [bar] S/G/L</b>						
<b>Maximum set pressure</b>	-268 to -60 °C	19.0	19.0	49.7	99.3	149.0	169.0	179.3
	-59 to -29 °C	19.0	19.0	49.7	99.3	149.0	248.3	248.3
	-28 to 38 °C	19.0	19.0	49.7	99.3	149.0	248.3	248.3
	39 to 232 °C	12.4	12.4	34.1	67.2	102.4	171.0	248.3
	233 to 427 °C	5.5	5.5	29.0	58.3	87.2	145.5	242.8
	428 to 538 °C	1.4	1.4	24.1	48.3	72.4	120.7	201.0
<b>Outlet pressure limit</b> Conventional design		19.0	19.0	19.0	19.0	41.4	41.4	49.7
<b>Outlet pressure limit</b> Balanced bellows design		15.9	15.9	15.9	15.9	32.4	32.4	32.4
<b>Body material: WC6 1.7357</b>		<b>Pressure range p [bar] S/G/L</b>						
<b>Maximum set pressure</b>	233 to 427 °C	–	–	35.2	70.0	105.2	175.2	255.5
	428 to 538 °C	–	–	14.8	29.7	44.8	74.5	124.1
<b>Outlet pressure limit</b> Conventional design		–	–	19.7	19.7	51.0	51.0	51.0
<b>Outlet pressure limit</b> Balanced bellows design		–	–	15.9	15.9	32.4	32.4	32.4
<b>Body material: LCB</b>		<b>Pressure range p [bar] S/G/L</b>						
<b>Maximum set pressure</b>	-46 to 38 °C	18.4	18.4	48.0	96.0	144.1	240.1	400.1
	39 to 200 °C	13.8	13.8	42.5	85.1	127.6	212.7	354.4
	201 to 343 °C	8.4	8.4	36.4	72.8	109.2	182.0	303.3
<b>Outlet pressure limit</b> Conventional design		18.4	18.4	18.4	18.4	48.0	48.0	48.0
<b>Outlet pressure limit</b> Balanced bellows design		15.9	15.9	15.9	15.9	32.4	32.4	32.4

Remark: SA 352 Gr. LCB is not listed in the API 526. Pressure-Temperature Rating acc. to ASME B16.34 Table 2-1.3  
The stated Pressure-Temperature Rating are taken from ASME B16.34 Table 2-1.3 if the maximum pressure is not limited by API 526.

Due to the extended material test certificate the LESER LCB can be applied as LCC, WCB, WCC and 1.0619 with the respective pressure-temperature range as well.

## Pressure temperature ratings

US Units		1 1/2 G 3	1 1/2 G 3	1 1/2 G 3	1 1/2 G 3	1 1/2 G 3	2 G 3	2 G 3
Valve size		1 1/2 G 3	1 1/2 G 3	1 1/2 G 3	1 1/2 G 3	1 1/2 G 3	2 G 3	2 G 3
Flange rating class	Inlet x Outlet	150 x 150	300L x 150	300 x 150	600 x 150	900 x 300	1500 x 300	2500 x 300
Actual Orifice diameter d <sub>0</sub>	[inch]	0.886	0.886	0.886	0.886	0.886	0.886	0.886
Actual Orifice area A <sub>0</sub>	[inch <sup>2</sup> ]	0.616	0.616	0.616	0.616	0.616	0.616	0.616
Minimum set pressure	[psig] S/G/L	3.0	3.0	3.0	3.0	3.0	73.0	73.0
Minimum set pressure	[psig] S/G	46.6	46.6	46.6	133.4	133.4	133.4	133.4
Balanced bellows Inconel	[psig] L	46.4	46.4	46.4	268.0	268.0	268.0	268.0
<b>Body material: WCB 1.0619</b>		<b>Pressure range p [psig] S/G/L</b>						
<b>Maximum set pressure</b>	-20 to 100 °F	285	285	740	1480	2220	3705	3705
	101 to 450 °F	185	285	615	1235	1845	3080	3705
	451 to 800 °F	80	285	410	825	1235	2060	3430
<b>Outlet pressure limit</b>	Conventional design	285	285	285	285	740	740	740
<b>Outlet pressure limit</b>	Balanced bellows design	230	230	230	230	470	470	470
<b>Body material: CF8M 1.4408</b>		<b>Pressure range p [psig] S/G/L</b>						
<b>Maximum set pressure</b>	-450 to -76 °F	275	275	720	1440	2160	2450	2600
	-75 to -21 °F	275	275	720	1440	2160	3600	3600
	-20 to 100 °F	275	275	720	1440	2160	3600	3600
	101 to 450 °F	180	180	495	975	1485	2480	3600
	451 to 800 °F	80	80	420	845	1265	2110	3520
	801 to 1000 °F	20	20	350	700	1050	1750	2915
<b>Outlet pressure limit</b>	Conventional design	275	275	275	275	600	600	720
<b>Outlet pressure limit</b>	Balanced bellows design	230	230	230	230	470	470	470
<b>Body material: WC6 1.7357</b>		<b>Pressure range p [psig] S/G/L</b>						
<b>Maximum set pressure</b>	451 to 800 °F	–	–	510	1015	1525	2540	3705
	801 to 1000 °F	–	–	215	430	650	1080	1800
<b>Outlet pressure limit</b>	Conventional design	–	–	285	285	740	740	740
<b>Outlet pressure limit</b>	Balanced bellows design	–	–	230	230	470	470	470
<b>Body material: LCB</b>		<b>Pressure range p [psig] S/G/L</b>						
<b>Maximum set pressure</b>	-50 to 100 °F	265	265	695	1395	2090	3480	5805
	101 to 400 °F	200	200	615	1230	1845	3075	5125
	401 to 650 °F	125	125	535	1065	1600	2665	4440
<b>Outlet pressure limit</b>	Conventional design	265	265	265	265	695	695	695
<b>Outlet pressure limit</b>	Balanced bellows design	230	230	230	230	470	470	470

Remark: SA 352 Gr. LCB is not listed in the API 526. Pressure-Temperature Rating acc. to ASME B16.34 Table 2-1.3  
The stated Pressure-Temperature Rating are taken from ASME B16.34 Table 2-1.3 if the maximum pressure is not limited by API 526.

Due to the extended material test certificate the LESER LCB can be applied as LCC, WCB, WCC and 1.0619 with the respective pressure-temperature range as well.



## Selection chart

	150 x 150	300L x 150	300 x 150	600 x 150	900 x 150	1500 x 300	2500 x 300
WCB	5262.142X	5262.143X	5262.144X	5262.145X	5262.146X	5262.147X	-
WC6	-	-	5267.148X	5267.149X	5267.150X	5267.151X	-

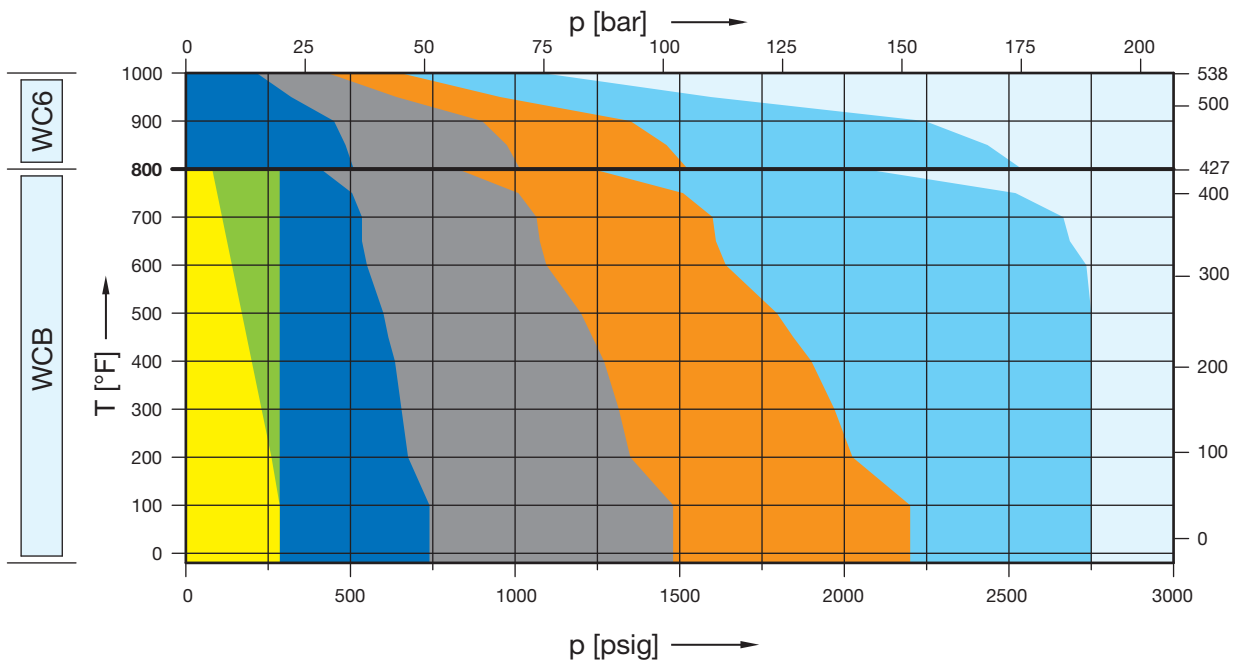

	150 x 150	300L x 150	300 x 150	600 x 150	900 x 150	1500 x 300	2500 x 300
CF8M	5264.152X	5264.153X	5264.154X	5264.155X	5264.156X	5264.157X	-

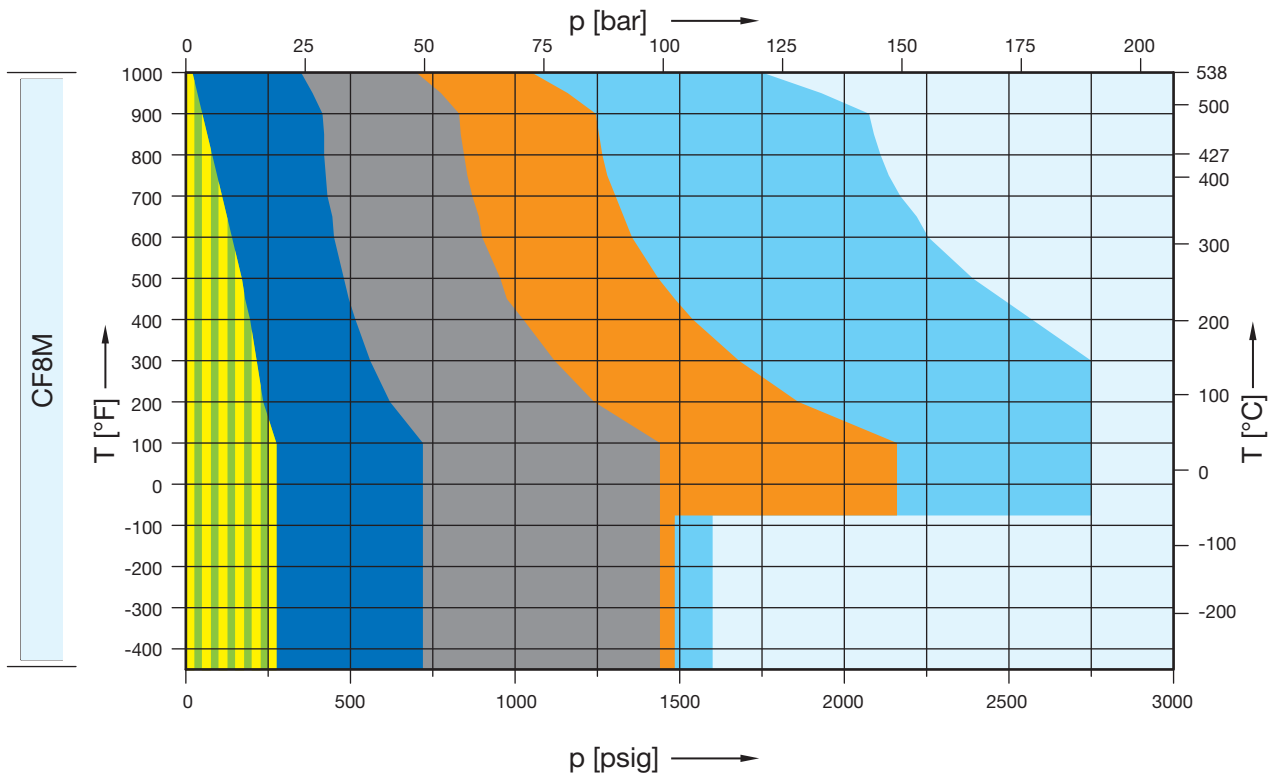

## Article numbers, dimensions and weights

### Article numbers

Valve size	1 1/2 H 3	1 1/2 H 3	2 H 3	2 H 3	2 H 3	2 H 3
Flange rating class Inlet x Outlet	150 x 150	300L x 150	300 x 150	600 x 150	900 x 150	1500 x 300
Actual Orifice diameter d <sub>0</sub> [mm]	28.3	28.3	28.3	28.3	28.3	28.3
Actual Orifice area A <sub>0</sub> [mm <sup>2</sup> ]	629	629	629	629	629	629

### Body material

WCB 1.0619	Art.-No.	5262.142 <sup>□</sup>	5262.143 <sup>□</sup>	5262.144 <sup>□</sup>	5262.145 <sup>□</sup>	5262.146 <sup>□</sup>	5262.147 <sup>□</sup>
CF8M 1.4408	Art.-No.	5264.152 <sup>□</sup>	5264.153 <sup>□</sup>	5264.154 <sup>□</sup>	5264.155 <sup>□</sup>	5264.156 <sup>□</sup>	5264.157 <sup>□</sup>
WC6 1.7357	Art.-No.	-	-	5267.148 <sup>□</sup>	5267.149 <sup>□</sup>	5267.150 <sup>□</sup>	5267.151 <sup>□</sup>
LCB	Art.-No.	5263.523 <sup>□</sup>	5263.524 <sup>□</sup>	5263.525 <sup>□</sup>	5263.526 <sup>□</sup>	5263.527 <sup>□</sup>	5263.528 <sup>□</sup>

<sup>□</sup> Please add code for the required cap or lifting device. See below.

### Dimensions and weights

#### Metric Units

<b>Weight</b> [kg]		30.6	30.6	44.6	62.2	62.2	62.2
	with bellows	33.1	33.1	48.4	65.3	65.3	65.3
<b>Center to face</b> [mm]	Inlet a	130	130	130	154	154	154
	Outlet b	124	124	124	162	162	162
	s	38	38	43	56	56	56
<b>Height (H4)</b> [mm]	Standard H max.	542	542	666	691	691	691
	Bellows H max.	580	580	692	717	717	717
<b>Support brackets</b> [mm]	A	162	162	184	184	184	184
	B	-	-	110	110	110	110
	C	Ø 14	Ø 14	Ø 14	Ø 14	Ø 14	Ø 14
	D	155	155	177	202	202	202
	E	16	16	16	16	16	16

#### US Units

<b>Weight</b> [lbs]		67.5	67.5	98.3	137.2	137.2	137.2
	with bellows	73	73	106.7	144	144	144
<b>Center to face</b> [inch]	Inlet a	5 1/8	5 1/8	5 1/8	6 1/16	6 1/16	6 1/16
	Outlet b	4 7/8	4 7/8	4 7/8	6 3/8	6 3/8	6 3/8
	s	1 1/2	1 1/2	1 1/16	2 3/16	2 3/16	2 3/16
<b>Height (H4)</b> [inch]	Standard H max.	21 11/32	21 11/32	26 7/32	27 7/32	27 7/32	27 7/32
	Bellows H max.	22 27/32	22 27/32	27 1/4	28 7/32	28 7/32	28 7/32
<b>Support brackets</b> [inch]	A	6 3/8	6 3/8	7 1/4	7 1/4	7 1/4	7 1/4
	B	-	-	4 11/32	4 11/32	4 11/32	4 11/32
	C	Ø 9/16	Ø 9/16	Ø 9/16	Ø 9/16	Ø 9/16	Ø 9/16
	D	6 3/32	6 3/32	6 31/32	7 15/16	7 15/16	7 15/16
	E	5/8	5/8	5/8	5/8	5/8	5/8

#### Code for lifting device

Lifting device	H2	H3	H4	H3
Bonnet	closed	closed	closed	open
WCB 1.0619, WC6 1.7357, LCB	2	3	4	5
CF8M 1.4408	2	-	4	-

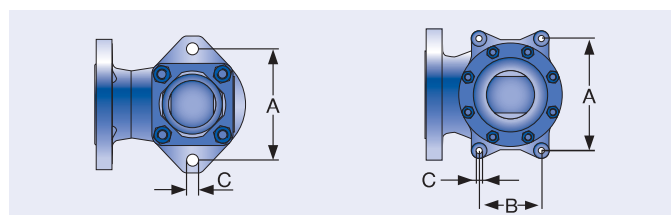

Support brackets

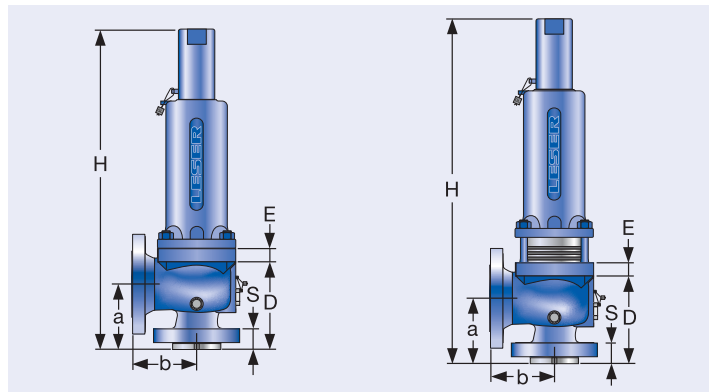

Conventional design

Balanced bellows design

## Pressure temperature ratings

Metric Units		1 1/2 H 3	1 1/2 H 3	2 H 3	2 H 3	2 H 3	2 H 3
Valve size		150 x 150	300L x 150	300 x 150	600 x 150	900 x 150	1500 x 300
Flange rating class	Inlet x Outlet	150 x 150	300L x 150	300 x 150	600 x 150	900 x 150	1500 x 300
Actual Orifice diameter d <sub>0</sub>	[mm]	28.3	28.3	28.3	28.3	28.3	28.3
Actual Orifice area A <sub>0</sub>	[mm <sup>2</sup> ]	625	625	625	625	625	625
Minimum set pressure	[bar] S/G/L	0.2	0.2	0.3	0.3	0.3	0.3
Minimum set pressure	[bar] S/G	3.2	3.2	6.5	6.5	6.5	6.5
Balanced bellows Inconel	[bar] L	3.2	3.2	12.0	12.0	12.0	12.0
<b>Body material: WCB 1.0619</b>		<b>Pressure range p [bar] S/G/L</b>					
<b>Maximum set pressure</b>	-29 to 38 °C	19.7	19.7	51.0	102.1	153.1	189.7
	39 to 232 °C	12.8	19.7	42.4	85.2	127.2	189.7
	233 to 427 °C	5.5	19.7	28.3	56.9	85.2	142.1
<b>Outlet pressure limit</b>	Conventional design	19.7	19.7	19.7	19.7	19.7	51.0
<b>Outlet pressure limit</b>	Balanced bellows design	15.9	15.9	15.9	15.9	15.9	28.6
<b>Body material: CF8M 1.4408</b>		<b>Pressure range p [bar] S/G/L</b>					
<b>Maximum set pressure</b>	-268 to -60 °C	19.0	19.0	49.7	99.3	102.4	110.3
	-59 to -29 °C	19.0	19.0	49.7	99.3	149.0	189.7
	-28 to 38 °C	19.0	19.0	49.7	99.3	149.0	189.7
	39 to 232 °C	12.4	12.4	34.1	67.2	102.4	171.0
	233 to 427 °C	5.5	5.5	29.0	58.3	87.2	145.5
	428 to 538 °C	1.4	1.4	24.1	48.3	72.4	120.7
<b>Outlet pressure limit</b>	Conventional design	19.0	19.0	19.0	19.0	41.4	41.4
<b>Outlet pressure limit</b>	Balanced bellows design	15.9	15.9	15.9	15.9	15.9	28.6
<b>Body material: WC6 1.7357</b>		<b>Pressure range p [bar] S/G/L</b>					
<b>Maximum set pressure</b>	233 to 427 °C	-	-	35.2	70.0	105.2	175.2
	428 to 538 °C	-	-	14.8	29.7	44.8	74.5
<b>Outlet pressure limit</b>	Conventional design	-	-	19.7	19.7	19.7	51.0
<b>Outlet pressure limit</b>	Balanced bellows design	-	-	15.9	15.9	15.9	28.6
<b>Body material: LCB</b>		<b>Pressure range p [bar] S/G/L</b>					
<b>Maximum set pressure</b>	-46 to 38 °C	18.4	18.4	48.0	96.0	144.1	240.1
	39 to 200 °C	13.8	13.8	42.5	85.1	127.6	212.7
	201 to 343 °C	8.4	8.4	36.4	72.8	109.2	182.0
<b>Outlet pressure limit</b>	Conventional design	18.4	18.4	18.4	18.4	18.4	48.0
<b>Outlet pressure limit</b>	Balanced bellows design	15.9	15.9	15.9	15.9	15.9	28.6

Remark: SA 352 Gr. LCB is not listed in the API 526. Pressure-Temperature Rating acc. to ASME B16.34 Table 2-1.3  
The stated Pressure-Temperature Rating are taken from ASME B16.34 Table 2-1.3 if the maximum pressure is not limited by API 526.

Due to the extended material test certificate the LESER LCB can be applied as LCC, WCB, WCC and 1.0619 with the respective pressure-temperature range as well.

## Pressure temperature ratings

US Units							
Valve size		1 1/2 H 3	1 1/2 H 3	2 H 3	2 H 3	2 H 3	2 H 3
Flange rating class <small>Inlet x Outlet</small>		150 x 150	300L x 150	300 x 150	600 x 150	900 x 150	1500 x 300
Actual Orifice diameter $d_0$ [inch]		1.11	1.11	1.11	1.11	1.11	1.11
Actual Orifice area $A_0$ [inch <sup>2</sup> ]		0.975	0.975	0.975	0.975	0.975	0.975
Minimum set pressure [psig] S/G/L		3.0	3.0	4.0	4.0	4.0	4.0
Minimum set pressure [psig] S/G		46.4	46.4	94.3	94.3	94.3	94.3
Balanced bellows Inconel [psig] L		46.4	46.4	174.0	174.0	174.0	174.0
<b>Body material: WCB 1.0619</b>		<b>Pressure range p [psig] S/G/L</b>					
<b>Maximum set pressure</b>	-20 to 100 °F	285	285	740	1480	2220	2750
	101 to 450 °F	185	285	615	1235	1845	2750
	451 to 800 °F	80	285	410	825	1235	2060
<b>Outlet pressure limit</b> Conventional design		285	285	285	285	285	740
<b>Outlet pressure limit</b> Balanced bellows design		230	230	230	230	230	415
<b>Body material: CF8M 1.4408</b>		<b>Pressure range p [psig] S/G/L</b>					
<b>Maximum set pressure</b>	-450 to -76 °F	275	275	720	1440	1485	1600
	-75 to -21 °F	275	275	720	1440	2160	2750
	-20 to 100 °F	275	275	720	1440	2160	2750
	101 to 450 °F	180	180	495	975	1485	2480
	451 to 800 °F	80	80	420	845	1265	2110
	801 to 1000 °F	20	20	350	700	1050	1750
<b>Outlet pressure limit</b> Conventional design		275	275	275	275	600	600
<b>Outlet pressure limit</b> Balanced bellows design		230	230	230	230	230	415
<b>Body material: WC6 1.7357</b>		<b>Pressure range p [psig] S/G/L</b>					
<b>Maximum set pressure</b>	451 to 800 °F	-	-	510	1015	1525	2540
	801 to 1000 °F	-	-	215	430	650	1080
<b>Outlet pressure limit</b> Conventional design		-	-	285	285	285	740
<b>Outlet pressure limit</b> Balanced bellows design		-	-	230	230	230	415
<b>Body material: LCB</b>		<b>Pressure range p [psig] S/G/L</b>					
<b>Maximum set pressure</b>	-50 to 100 °F	265	265	695	1395	2090	3480
	101 to 400 °F	200	200	615	1230	1845	3075
	401 to 650 °F	125	125	535	1065	1600	2665
<b>Outlet pressure limit</b> Conventional design		265	265	265	265	265	695
<b>Outlet pressure limit</b> Balanced bellows design		230	230	230	230	230	415

Remark: SA 352 Gr. LCB is not listed in the API 526. Pressure-Temperature Rating acc. to ASME B16.34 Table 2-1.3  
The stated Pressure-Temperature Rating are taken from ASME B16.34 Table 2-1.3 if the maximum pressure is not limited by API 526.

Due to the extended material test certificate the LESER LCB can be applied as LCC, WCB, WCC and 1.0619 with the respective pressure-temperature range as well.

## Selection chart

	150 x 150	300L x 150	300 x 150	600 x 150	900 x 150	1500 x 300	2500 x 300
WCB	5262.162X	5262.163X	5262.164X	5262.165X	5262.166X	5262.167X	-
WC6	-	-	5267.168X	5267.169X	5267.170X	5267.171X	-

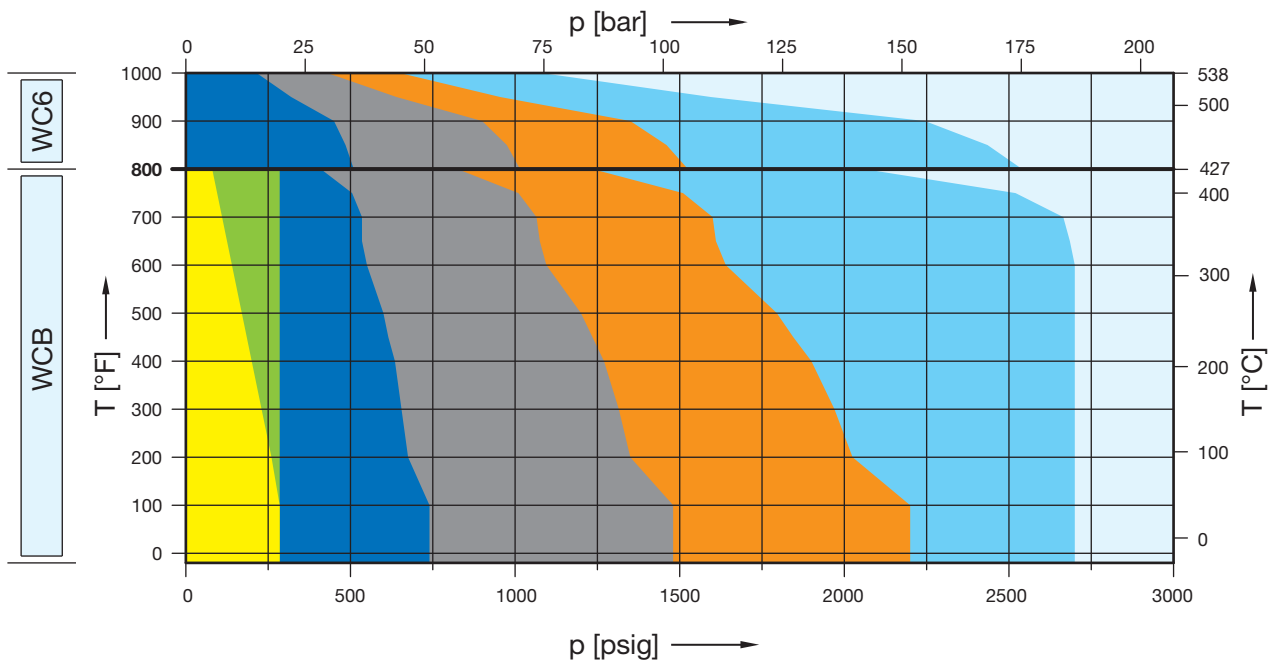

	150 x 150	300L x 150	300 x 150	600 x 150	900 x 150	1500 x 300	2500 x 300
CF8M	5264.196X	5264.197X	5264.198X	5264.199X	5264.200X	5264.201X	-

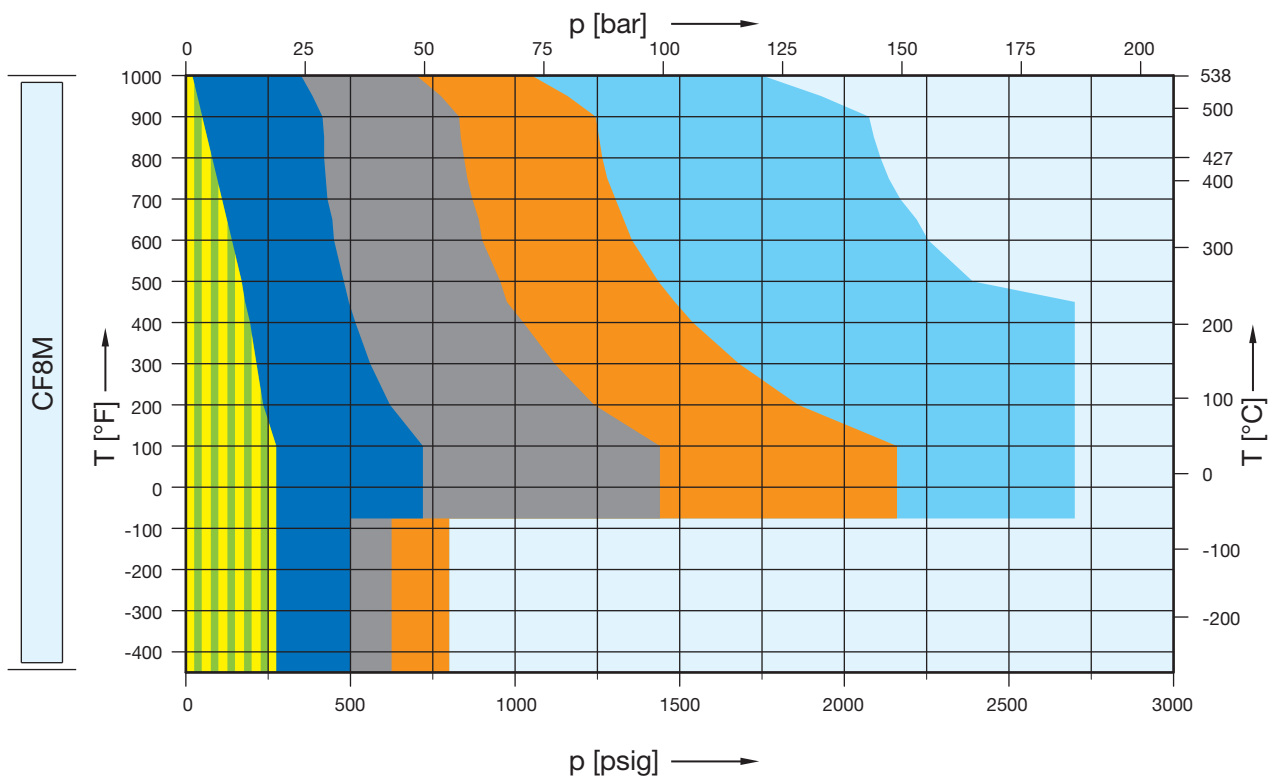

## Article numbers, dimensions and weights

### Article numbers

Valve size	2 J 3	2 J 3	3 J 4	3 J 4	3 J 4	3 J 4
Flange rating class <small>Inlet x Outlet</small>	150 x 150	300L x 150	300 x 150	600 x 150	900 x 150	1500 x 300
Actual Orifice diameter $d_0$ [mm]	36.0	36.0	36.0	36.0	36.0	36.0
Actual Orifice area $A_0$ [mm <sup>2</sup> ]	1018	1018	1018	1018	1018	1018

### Body material

WCB 1.0619	Art.-No.	5262.162 <sup>□</sup>	5262.163 <sup>□</sup>	5262.164 <sup>□</sup>	5262.165 <sup>□</sup>	5262.166 <sup>□</sup>	5262.167 <sup>□</sup>
CF8M 1.4408	Art.-No.	5264.196 <sup>□</sup>	5264.197 <sup>□</sup>	5264.198 <sup>□</sup>	5264.199 <sup>□</sup>	5264.200 <sup>□</sup>	5264.201 <sup>□</sup>
WC6 1.7357	Art.-No.	-	-	5267.168 <sup>□</sup>	5267.169 <sup>□</sup>	5267.170 <sup>□</sup>	5267.171 <sup>□</sup>
LCB	Art.-No.	5263.529 <sup>□</sup>	5263.530 <sup>□</sup>	5263.531 <sup>□</sup>	5263.532 <sup>□</sup>	5263.533 <sup>□</sup>	5263.534 <sup>□</sup>

<sup>□</sup> Please add code for the required cap or lifting device. See below.

### Dimensions and weights

#### Metric Units

<b>Weight</b> [kg]		44.6	44.6	77.7	77.7	100.2	100.2
	with bellows	48.4	48.4	83.2	83.2	105.7	105.7
<b>Center to face</b> [mm]	Inlet a	137	137	184	184	184	184
	Outlet b	124	124	181	181	181	181
	s	49	49	49	49	65	65
<b>Height (H4)</b> [mm]	Standard H max.	673	673	786	786	786	786
	Bellows H max.	722	722	824	824	824	824
<b>Support brackets</b> [mm]	A	184	184	238	238	238	238
	B	110	110	140	140	140	140
	C	Ø 14	Ø 14	Ø 18	Ø 18	Ø 18	Ø 18
	D	184	184	234	234	234	234
	E	16	16	25	25	25	25

#### US Units

<b>Weight</b> [lbs]		98.3	98.3	171.3	171.3	220.9	220.9
	with bellows	106.7	106.7	183.5	183.5	233.1	233.1
<b>Center to face</b> [inch]	Inlet a	5 <sup>3</sup> / <sub>8</sub>	5 <sup>3</sup> / <sub>8</sub>	7 <sup>1</sup> / <sub>4</sub>	7 <sup>1</sup> / <sub>4</sub>	7 <sup>1</sup> / <sub>4</sub>	7 <sup>1</sup> / <sub>4</sub>
	Outlet b	4 <sup>7</sup> / <sub>8</sub>	4 <sup>7</sup> / <sub>8</sub>	7 <sup>1</sup> / <sub>8</sub>	7 <sup>1</sup> / <sub>8</sub>	7 <sup>1</sup> / <sub>8</sub>	7 <sup>1</sup> / <sub>8</sub>
	s	1 <sup>15</sup> / <sub>16</sub>	1 <sup>15</sup> / <sub>16</sub>	1 <sup>15</sup> / <sub>16</sub>	1 <sup>15</sup> / <sub>16</sub>	2 <sup>9</sup> / <sub>16</sub>	2 <sup>9</sup> / <sub>16</sub>
<b>Height (H4)</b> [inch]	Standard H max.	26 <sup>1</sup> / <sub>2</sub>	26 <sup>1</sup> / <sub>2</sub>	30 <sup>15</sup> / <sub>16</sub>	30 <sup>15</sup> / <sub>16</sub>	30 <sup>15</sup> / <sub>16</sub>	30 <sup>15</sup> / <sub>16</sub>
	Bellows H max.	28 <sup>7</sup> / <sub>16</sub>	28 <sup>7</sup> / <sub>16</sub>	32 <sup>7</sup> / <sub>16</sub>	32 <sup>7</sup> / <sub>16</sub>	32 <sup>7</sup> / <sub>16</sub>	32 <sup>7</sup> / <sub>16</sub>
<b>Support brackets</b> [inch]	A	7 <sup>1</sup> / <sub>4</sub>	7 <sup>1</sup> / <sub>4</sub>	9 <sup>3</sup> / <sub>8</sub>	9 <sup>3</sup> / <sub>8</sub>	9 <sup>3</sup> / <sub>8</sub>	9 <sup>3</sup> / <sub>8</sub>
	B	4 <sup>11</sup> / <sub>32</sub>	4 <sup>11</sup> / <sub>32</sub>	5 <sup>1</sup> / <sub>2</sub>	5 <sup>1</sup> / <sub>2</sub>	5 <sup>1</sup> / <sub>2</sub>	5 <sup>1</sup> / <sub>2</sub>
	C	Ø <sup>9</sup> / <sub>16</sub>	Ø <sup>9</sup> / <sub>16</sub>	Ø <sup>23</sup> / <sub>32</sub>	Ø <sup>23</sup> / <sub>32</sub>	Ø <sup>23</sup> / <sub>32</sub>	Ø <sup>23</sup> / <sub>32</sub>
	D	7 <sup>1</sup> / <sub>4</sub>	7 <sup>1</sup> / <sub>4</sub>	9 <sup>7</sup> / <sub>32</sub>	9 <sup>7</sup> / <sub>32</sub>	9 <sup>7</sup> / <sub>32</sub>	9 <sup>7</sup> / <sub>32</sub>
	E	<sup>5</sup> / <sub>8</sub>	<sup>5</sup> / <sub>8</sub>	<sup>31</sup> / <sub>32</sub>	<sup>31</sup> / <sub>32</sub>	<sup>31</sup> / <sub>32</sub>	<sup>31</sup> / <sub>32</sub>

### Code for lifting device

Lifting device	H2	H3	H4	H3
Bonnet	closed	closed	closed	open
WCB 1.0619, WC6 1.7357, LCB	2	3	4	5
CF8M 1.4408	2	-	4	-

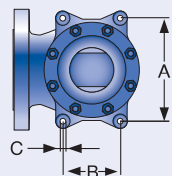

Support brackets

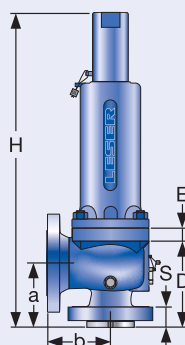

Conventional design

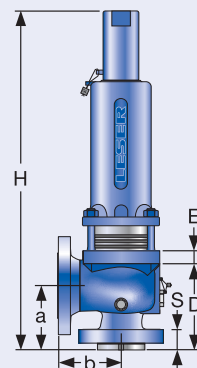

Balanced bellows design



## Pressure temperature ratings

Metric Units							
Valve size		2 J 3	2 J 3	3 J 4	3 J 4	3 J 4	3 J 4
Flange rating class <small>Inlet x Outlet</small>		150 x 150	300L x 150	300 x 150	600 x 150	900 x 150	1500 x 300
Actual Orifice diameter $d_0$ [mm]		36.0	36.0	36.0	36.0	36.0	36.0
Actual Orifice area $A_0$ [mm <sup>2</sup> ]		1018	1018	1018	1018	1018	1018
Minimum set pressure [bar] S/G/L		0.2	0.2	0.8	0.8	0.8	0.8
Minimum set pressure [bar] S/G		3.5	3.5	3.5	3.5	3.5	3.5
Balanced bellows Inconel [bar] L		5.0	5.0	5.0	5.0	5.0	5.0
<b>Body material: WCB 1.0619</b>		<b>Pressure range p [bar] S/G/L</b>					
<b>Maximum set pressure</b>	-29 to 38 °C	19.7	19.7	51.0	102.1	153.1	186.2
	39 to 232 °C	12.8	19.7	42.4	85.2	127.2	186.2
	233 to 427 °C	5.5	19.7	28.3	56.9	85.2	142.1
<b>Outlet pressure limit</b> Conventional design		19.7	19.7	19.7	19.7	19.7	41.4
<b>Outlet pressure limit</b> Balanced bellows design		15.9	15.9	15.9	15.9	15.9	15.9
<b>Body material: CF8M 1.4408</b>		<b>Pressure range p [bar] S/G/L</b>					
<b>Maximum set pressure</b>	-268 to -60 °C	19.0	19.0	34.5	43.1	55.2	55.2
	-59 to -29 °C	19.0	19.0	49.7	99.3	149.0	186.2
	-28 to 38 °C	19.0	19.0	49.7	99.3	149.0	186.2
	39 to 232 °C	12.4	12.4	34.1	67.2	102.4	171.0
	233 to 427 °C	5.5	5.5	29.0	58.3	87.2	145.5
	428 to 538 °C	1.4	1.4	24.1	48.3	72.4	120.7
<b>Outlet pressure limit</b> Conventional design		19.0	19.0	19.0	19.0	19.0	41.4
<b>Outlet pressure limit</b> Balanced bellows design		15.9	15.9	15.9	15.9	15.9	15.9
<b>Body material: WC6 1.7357</b>		<b>Pressure range p [bar] S/G/L</b>					
<b>Maximum set pressure</b>	233 to 427 °C	–	–	35.2	70.0	105.2	175.2
	428 to 538 °C	–	–	14.8	29.7	44.8	74.5
<b>Outlet pressure limit</b> Conventional design		–	–	19.7	19.7	19.7	41.4
<b>Outlet pressure limit</b> Balanced bellows design		–	–	15.9	15.9	15.9	15.9
<b>Body material: LCB</b>		<b>Pressure range p [bar] S/G/L</b>					
<b>Maximum set pressure</b>	-46 to 38 °C	18.4	18.4	48.0	96.0	144.1	240.1
	39 to 200 °C	13.8	13.8	42.5	85.1	127.6	212.7
	201 to 343 °C	8.4	8.4	36.4	72.8	109.2	182.0
<b>Outlet pressure limit</b> Conventional design		18.4	18.4	18.4	18.4	18.4	41.4
<b>Outlet pressure limit</b> Balanced bellows design		15.9	15.9	15.9	15.9	15.9	15.9

Remark: SA 352 Gr. LCB is not listed in the API 526. Pressure-Temperature Rating acc. to ASME B16.34 Table 2-1.3  
The stated Pressure-Temperature Rating are taken from ASME B16.34 Table 2-1.3 if the maximum pressure is not limited by API 526.

Due to the extended material test certificate the LESER LCB can be applied as LCC, WCB, WCC and 1.0619 with the respective pressure-temperature range as well.

## Pressure temperature ratings

US Units							
Valve size		2 J 3	2 J 3	3 J 4	3 J 4	3 J 4	3 J 4
Flange rating class <small>Inlet x Outlet</small>		150 x 150	300L x 150	300 x 150	600 x 150	900 x 150	1500 x 300
Actual Orifice diameter $d_0$ [inch]		1.42	1.42	1.42	1.42	1.42	1.42
Actual Orifice area $A_0$ [inch <sup>2</sup> ]		1.58	1.58	1.58	1.58	1.58	1.58
Minimum set pressure [psig] S/G/L		3.0	3.0	12.0	12.0	12.0	12.0
Minimum set pressure [psig] S/G		50.8	50.8	50.8	50.8	50.8	50.8
Balanced bellows Inconel [psig] L		72.5	72.5	72.5	72.5	72.5	72.5
<b>Body material: WCB 1.0619</b>		<b>Pressure range p [psig] S/G/L</b>					
<b>Maximum set pressure</b>	-20 to 100 °F	285	285	740	1480	2220	2700
	101 to 450 °F	185	285	615	1235	1845	2700
	451 to 800 °F	80	285	410	825	1235	2060
<b>Outlet pressure limit</b> Conventional design		285	285	285	285	285	600
<b>Outlet pressure limit</b> Balanced bellows design		230	230	230	230	230	230
<b>Body material: CF8M 1.4408</b>		<b>Pressure range p [psig] S/G/L</b>					
<b>Maximum set pressure</b>	-450 to -76 °F	275	275	500	625	800	800
	-75 to -21 °F	275	275	720	1440	2160	2700
	-20 to 100 °F	275	275	720	1440	2160	2700
	101 to 450 °F	180	180	495	975	1485	2480
	451 to 800 °F	80	80	420	845	1265	2110
	801 to 1000 °F	20	20	350	700	1050	1750
<b>Outlet pressure limit</b> Conventional design		275	275	275	275	275	600
<b>Outlet pressure limit</b> Balanced bellows design		230	230	230	230	230	230
<b>Body material: WC6 1.7357</b>		<b>Pressure range p [psig] S/G/L</b>					
<b>Maximum set pressure</b>	451 to 800 °F	–	–	510	1015	1525	2540
	801 to 1000 °F	–	–	215	430	650	1080
<b>Outlet pressure limit</b> Conventional design		–	–	285	285	285	600
<b>Outlet pressure limit</b> Balanced bellows design		–	–	230	230	230	230
<b>Body material: LCB</b>		<b>Pressure range p [psig] S/G/L</b>					
<b>Maximum set pressure</b>	-50 to 100 °F	265	265	695	1395	2090	3480
	101 to 400 °F	200	200	615	1230	1845	3075
	401 to 650 °F	125	125	535	1065	1600	2665
<b>Outlet pressure limit</b> Conventional design		265	265	265	265	265	600
<b>Outlet pressure limit</b> Balanced bellows design		230	230	230	230	230	230

Remark: SA 352 Gr. LCB is not listed in the API 526. Pressure-Temperature Rating acc. to ASME B16.34 Table 2-1.3  
The stated Pressure-Temperature Rating are taken from ASME B16.34 Table 2-1.3 if the maximum pressure is not limited by API 526.

Due to the extended material test certificate the LESER LCB can be applied as LCC, WCB, WCC and 1.0619 with the respective pressure-temperature range as well.

## Selection chart

	150 x 150	300L x 150	300 x 150	600 x 150	900 x 150	1500 x 300	2500 x 300
WCB	5262.202X	See 300 x 150	5262.203X	5262.204X	5262.205X	5262.206X	-
WC6	-	See 300 x 150	5267.207X	5267.208X	5267.209X	5267.210X	-

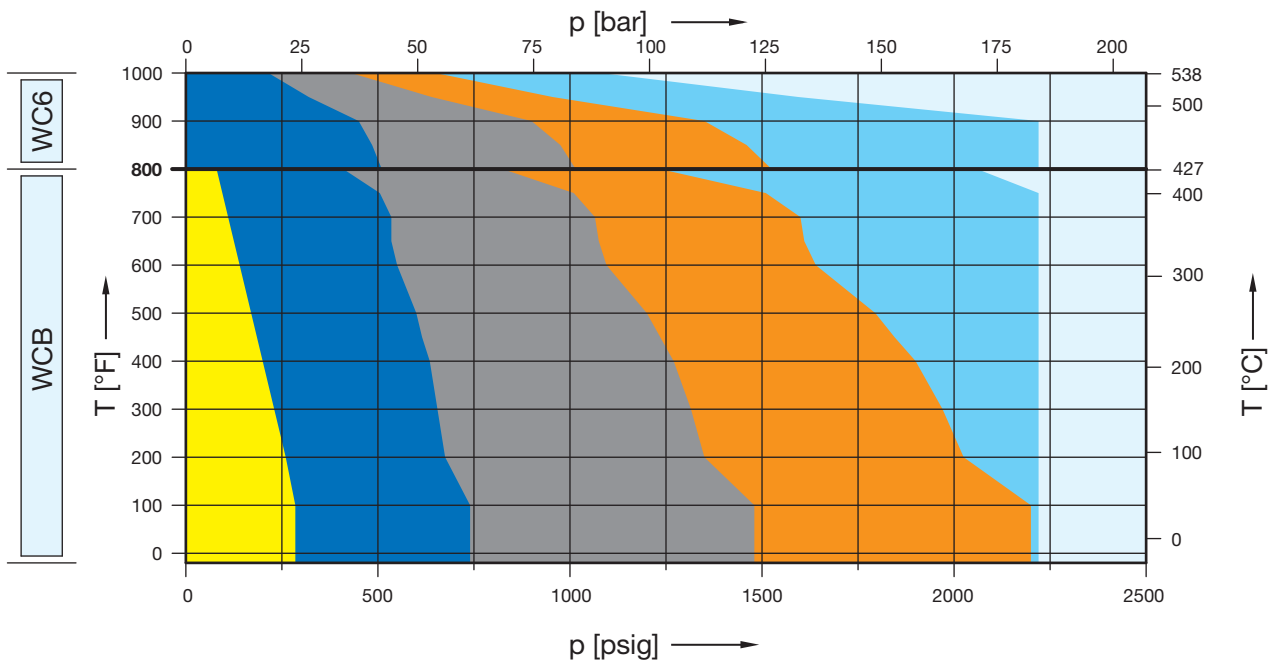

	150 x 150	300L x 150	300 x 150	600 x 150	900 x 150	1500 x 300	2500 x 300
CF8M	5264.211X	See 300 x 150	5264.212X	5264.213X	5264.214X	5264.215X	-

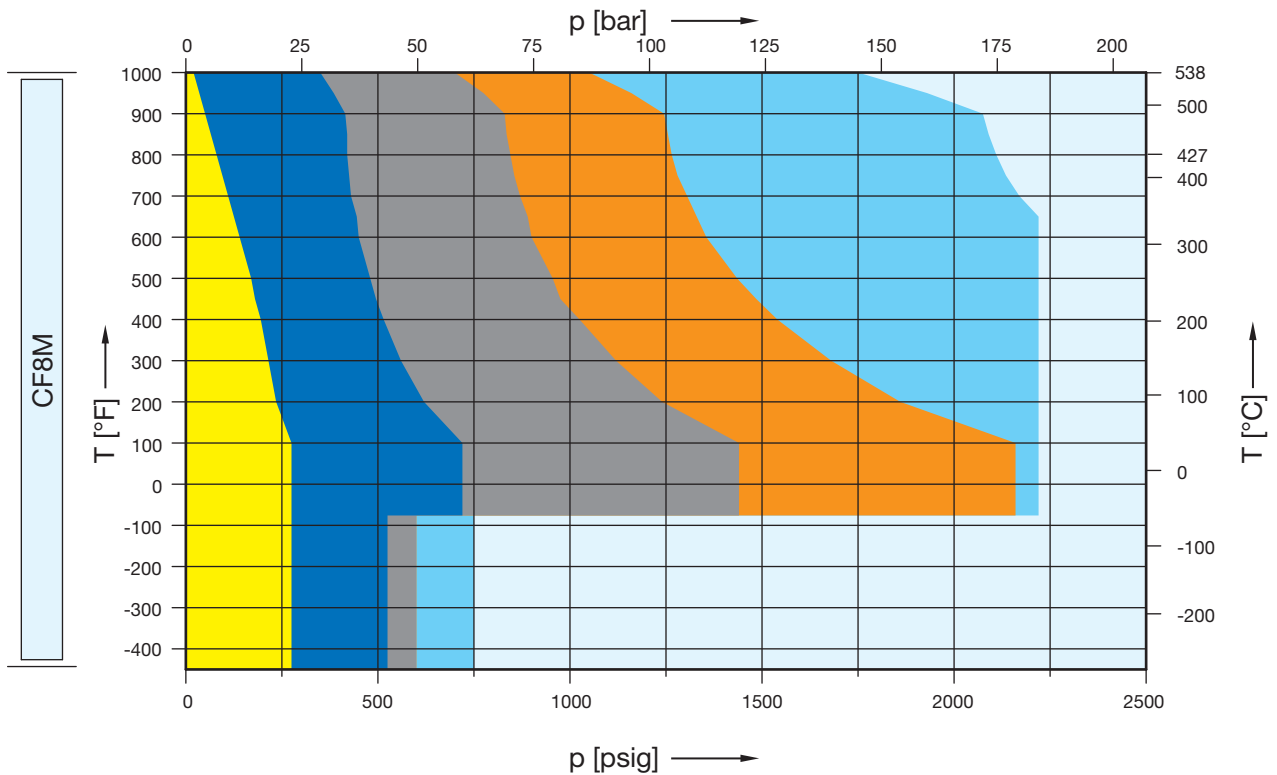

## Article numbers, dimensions and weights

### Article numbers

Valve size	3 K 4	3 K 4	3 K 4	3 K 4	3 K 6	3 K 6
Flange rating class $d_{inlet} \times d_{outlet}$	150 x 150	300L x 150	300 x 150	600 x 150	900 x 150	1500 x 300
Actual Orifice diameter $d_0$ [mm]	43.0	43.0	43.0	43.0	43.0	43.0
Actual Orifice area $A_0$ [mm <sup>2</sup> ]	1452	1452	1452	1452	1452	1452

### Body material

Material	Art.-No.	5262.202 <sup>□</sup>	Use 3 K 4 300 x 150	5262.203 <sup>□</sup>	5262.204 <sup>□</sup>	5262.205 <sup>□</sup>	5262.206 <sup>□</sup>
WCB 1.0619	Art.-No.	5262.202 <sup>□</sup>		5262.203 <sup>□</sup>	5262.204 <sup>□</sup>	5262.205 <sup>□</sup>	5262.206 <sup>□</sup>
CF8M 1.4408	Art.-No.	5264.111 <sup>□</sup>		5264.112 <sup>□</sup>	5264.113 <sup>□</sup>	5264.114 <sup>□</sup>	5264.115 <sup>□</sup>
WC6 1.7357	Art.-No.	-		5267.207 <sup>□</sup>	5267.208 <sup>□</sup>	5267.209 <sup>□</sup>	5267.210 <sup>□</sup>
LCB	Art.-No.	5263.535 <sup>□</sup>	5263.536 <sup>□</sup>	5263.537 <sup>□</sup>	5263.538 <sup>□</sup>	5263.539 <sup>□</sup>	

<sup>□</sup> Please add code for the required cap or lifting device. See below.

### Dimensions and weights

#### Metric Units

				Other	WC6			
Weight [kg]		70.1	Use 3 K 4 300 x 150	70.1	77.7	70.1	127.5	127.5
	with bellows	75.7		75.7	83.2	75.7	134.1	134.1
Center to face [mm]	Inlet a	156		156	184	156	198	197
	Outlet b	162		162	181	162	216	216
	s	49	49	49	49	67	65	
Height (H4) [mm]	Standard H max.	758	758	786	758	880	879	
	Bellows H max.	796	796	824	796	880	879	
Support brackets [mm]	A	238	238	238	238	278	278	
	B	140	140	140	140	160	160	
	C	Ø 18	Ø 18	Ø 18	Ø 18	Ø 18	Ø 18	
	D	206	206	234	206	288	287	
	E	25	25	25	25	25	25	

#### US Units

Weight [lbs]		154.6	Use 3 K 4 300 x 150	154.6	171.3	154.6	281.1	281.1
	with bellows	166.9		166.9	183.5	166.9	295.7	295.7
Center to face [inch]	Inlet a	6 1/8		6 1/8	7 1/4	6 1/8	7 13/16	7 3/4
	Outlet b	6 3/8		6 3/8	7 1/8	6 3/8	8 1/2	8 1/2
	s	1 15/16	1 15/16	1 15/16	1 15/16	2 9/16	2 9/16	
Height (H4) [inch]	Standard H max.	29 27/32	29 27/32	30 15/16	29 27/32	34 21/32	34 19/32	
	Bellows H max.	31 11/32	31 11/32	32 7/16	31 11/32	34 21/32	34 19/32	
Support brackets [inch]	A	9 3/8	9 3/8	9 3/8	9 3/8	10 15/16	10 15/16	
	B	5 1/2	5 1/2	5 1/2	5 1/2	6 5/16	6 5/16	
	C	Ø 23/32	Ø 23/32	Ø 23/32	Ø 23/32	Ø 23/32	Ø 23/32	
	D	8 3/32	8 3/32	9 7/32	8 3/32	11 11/32	11 9/32	
	E	31/32	31/32	31/32	31/32	31/32	31/32	

### Code for lifting device

Lifting device	H2	H3	H4	H3
Bonnet	closed	closed	closed	open
WCB 1.0619, WC6 1.7357, LCB	2	3	4	5
CF8M 1.4408	2	-	4	-

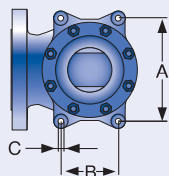

Support brackets

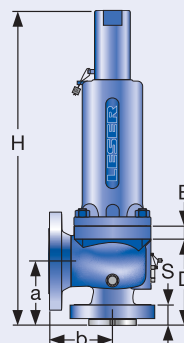

Conventional design

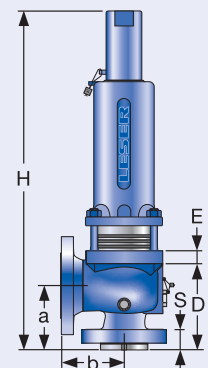

Balanced bellows design

## Pressure temperature ratings

Metric Units							
Valve size		3 K 4	3 K 4	3 K 4	3 K 4	3 K 6	3 K 6
Flange rating class <small>Inlet x Outlet</small>		150 x 150	300L x 150	300 x 150	600 x 150	900 x 150	1500 x 300
Actual Orifice diameter $d_0$ [mm]		43.0	43.0	43.0	43.0	43.0	43.0
Actual Orifice area $A_0$ [mm <sup>2</sup> ]		1452	1452	1452	1452	1452	1452
Minimum set pressure [bar] S/G/L		0.3	0.3	0.3	0.3	2.3	2.3
	WC6 only					0.3	0.3
Minimum set pressure [bar] S/G		2.2	2.2	2.2	5.6	5.6	5.6
Balanced bellows Inconel [bar] L		2.5	2.5	2.5	6.5	6.5	6.5
<b>Body material: WCB 1.0619</b>		<b>Pressure range p [bar] S/G/L</b>					
<b>Maximum set pressure</b>	-29 to 38 °C	19.7	Use 3 K 4 300 x 150	51.0	102.1	153.1	153.1
	39 to 232 °C	12.8		42.4	85.2	127.2	153.1
	233 to 427 °C	5.5		28.3	56.9	85.2	142.1
<b>Outlet pressure limit</b> Conventional design		19.7		19.7	19.7	19.7	41.4
<b>Outlet pressure limit</b> Balanced bellows design		10.3		10.3	13.8	13.8	13.8
<b>Body material: CF8M 1.4408</b>		<b>Pressure range p [bar] S/G/L</b>					
<b>Maximum set pressure</b>	-268 to -60 °C	19.0	Use 3 K 4 300 x 150	36.2	41.4	41.4	51.7
	-59 to -29 °C	19.0		49.7	99.3	149.0	153.1
	-28 to 38 °C	19.0		49.7	99.3	149.0	153.1
	39 to 232 °C	12.4		34.1	67.2	102.4	171.0
	233 to 427 °C	5.5		29.0	58.3	87.2	145.5
	428 to 538 °C	1.4		24.1	48.3	72.4	120.7
<b>Outlet pressure limit</b> Conventional design		19.0		19.0	19.0	19.0	41.4
<b>Outlet pressure limit</b> Balanced bellows design		10.3		10.3	13.8	13.8	13.8
<b>Body material: WC6 1.7357</b>		<b>Pressure range p [bar] S/G/L</b>					
<b>Maximum set pressure</b>	233 to 427 °C	–	–	35.2	70.0	105.2	153.1
	428 to 538 °C	–	–	14.8	29.7	44.8	74.5
<b>Outlet pressure limit</b> Conventional design		–	–	19.7	19.7	19.7	41.4
<b>Outlet pressure limit</b> Balanced bellows design		–	–	10.3	13.8	13.8	13.8
<b>Body material: LCB</b>		<b>Pressure range p [bar] S/G/L</b>					
<b>Maximum set pressure</b>	-46 to 38 °C	18.4	Use 3 K 4 300 x 150	48.0	96.0	144.1	240.1
	39 to 200 °C	13.8		42.5	85.1	127.6	212.7
	201 to 343 °C	8.4		36.4	72.8	109.2	182.0
<b>Outlet pressure limit</b> Conventional design		18.4		18.4	18.4	18.4	41.4
<b>Outlet pressure limit</b> Balanced bellows design		10.3		10.3	13.8	13.8	13.8

Remark: SA 352 Gr. LCB is not listed in the API 526. Pressure-Temperature Rating acc. to ASME B16.34 Table 2-1.3  
The stated Pressure-Temperature Rating are taken from ASME B16.34 Table 2-1.3 if the maximum pressure is not limited by API 526.

Due to the extended material test certificate the LESER LCB can be applied as LCC, WCB, WCC and 1.0619 with the respective pressure-temperature range as well.

## Pressure temperature ratings

US Units							
Valve size	3 K 4	3 K 4	3 K 4	3 K 4	3 K 6	3 K 6	
Flange rating class <small>Inlet x Outlet</small>	150 x 150	300L x 150	300 x 150	600 x 150	900 x 150	1500 x 300	
Actual Orifice diameter $d_0$ [inch]	1.69	1.69	1.69	1.69	1.69	1.69	
Actual Orifice area $A_0$ [inch <sup>2</sup> ]	2.25	2.25	2.25	2.25	2.25	2.25	
Minimum set pressure [psig] S/G/L	4.0	4.0	4.0	4.0	33.0	33.0	
Minimum set pressure [psig] S/G	31.9	31.9	31.9	81.2	81.2	81.2	
Balanced bellows Inconel [psig] L	36.3	36.3	36.3	94.3	94.3	94.3	
<b>Body material: WCB 1.0619</b>							
<b>Pressure range p [psig] S/G/L</b>							
<b>Maximum set pressure</b>	-20 to 100 °F	285	Use 3 K 4 300 x 150	740	1480	2220	2200
	101 to 450 °F	185		615	1235	1845	2200
	451 to 800 °F	80		410	825	1235	2060
<b>Outlet pressure limit</b> Conventional design	285		285	285	285	600	
<b>Outlet pressure limit</b> Balanced bellows design	150		150	200	200	200	
<b>Body material: CF8M 1.4408</b>							
<b>Pressure range p [psig] S/G/L</b>							
<b>Maximum set pressure</b>	-450 to -76 °F	275	Use 3 K 4 300 x 150	525	600	600	750
	-75 to -21 °F	275		720	1440	2160	2220
	-20 to 100 °F	275		720	1440	2160	2220
	101 to 450 °F	180		495	975	1485	2480
	451 to 800 °F	80		420	845	1265	2110
	801 to 1000 °F	20		350	700	1050	1750
<b>Outlet pressure limit</b> Conventional design	275		275	275	275	600	
<b>Outlet pressure limit</b> Balanced bellows design	150		150	200	200	200	
<b>Body material: WC6 1.7357</b>							
<b>Pressure range p [psig] S/G/L</b>							
<b>Maximum set pressure</b>	451 to 800 °F	-	-	510	1015	1525	2220
	801 to 1000 °F	-	-	215	430	650	1080
<b>Outlet pressure limit</b> Conventional design	-	-	285	285	285	600	
<b>Outlet pressure limit</b> Balanced bellows design	-	-	150	200	200	200	
<b>Body material: LCB</b>							
<b>Pressure range p [psig] S/G/L</b>							
<b>Maximum set pressure</b>	-50 to 100 °F	265	Use 3 K 4 300 x 150	695	1395	2090	3480
	101 to 400 °F	200		615	1230	1845	3075
	401 to 650 °F	125		535	1065	1600	2665
<b>Outlet pressure limit</b> Conventional design	265		265	265	265	265	
<b>Outlet pressure limit</b> Balanced bellows design	150		150	200	200	200	

Remark: SA 352 Gr. LCB is not listed in the API 526. Pressure-Temperature Rating acc. to ASME B16.34 Table 2-1.3  
The stated Pressure-Temperature Rating are taken from ASME B16.34 Table 2-1.3 if the maximum pressure is not limited by API 526.

Due to the extended material test certificate the LESER LCB can be applied as LCC, WCB, WCC and 1.0619 with the respective pressure-temperature range as well.



## Selection chart

	150 x 150	300L x 150	300 x 150	600 x 150	900 x 150	1500 x 150	2500 x 300
WCB	5262.232X	5262.233X	5262.234X	5262.235X	5262.236X	5262.237X	-
WC6	-	-	5267.238X	5267.239X	5267.240X	5267.241X	-

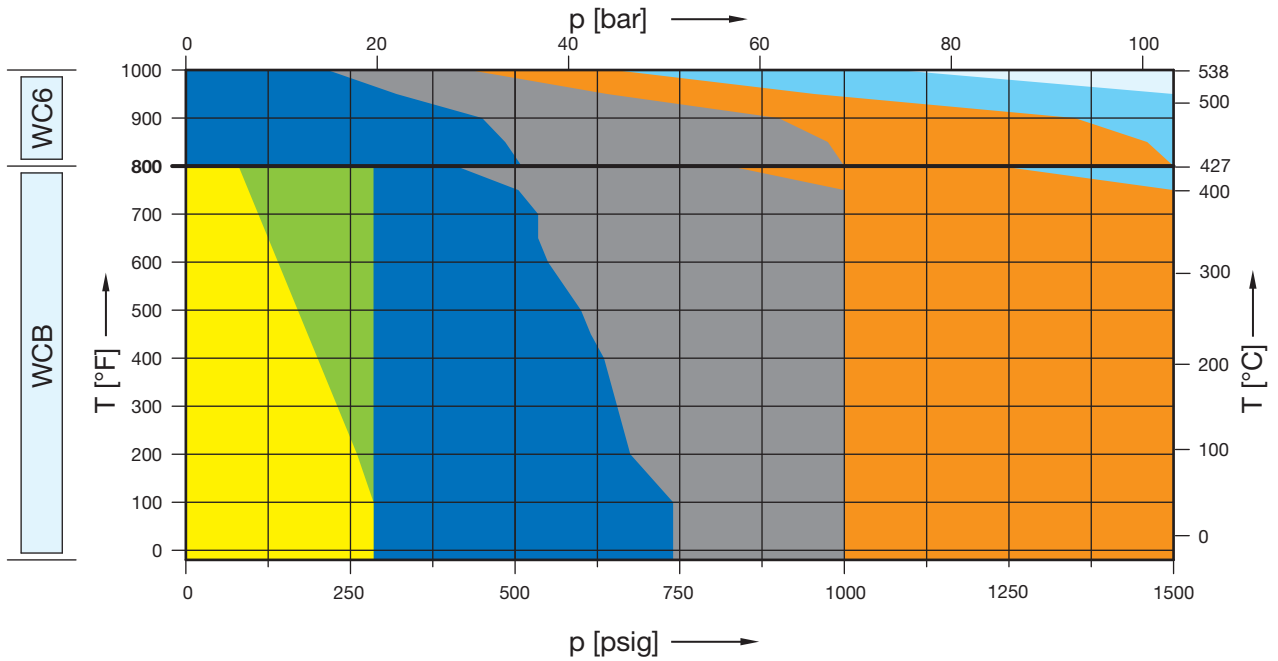

	150 x 150	300L x 150	300 x 150	600 x 150	900 x 150	1500 x 150	2500 x 300
CF8M	5264.242X	5264.243X	5264.244X	5264.245X	5264.246X	-	-

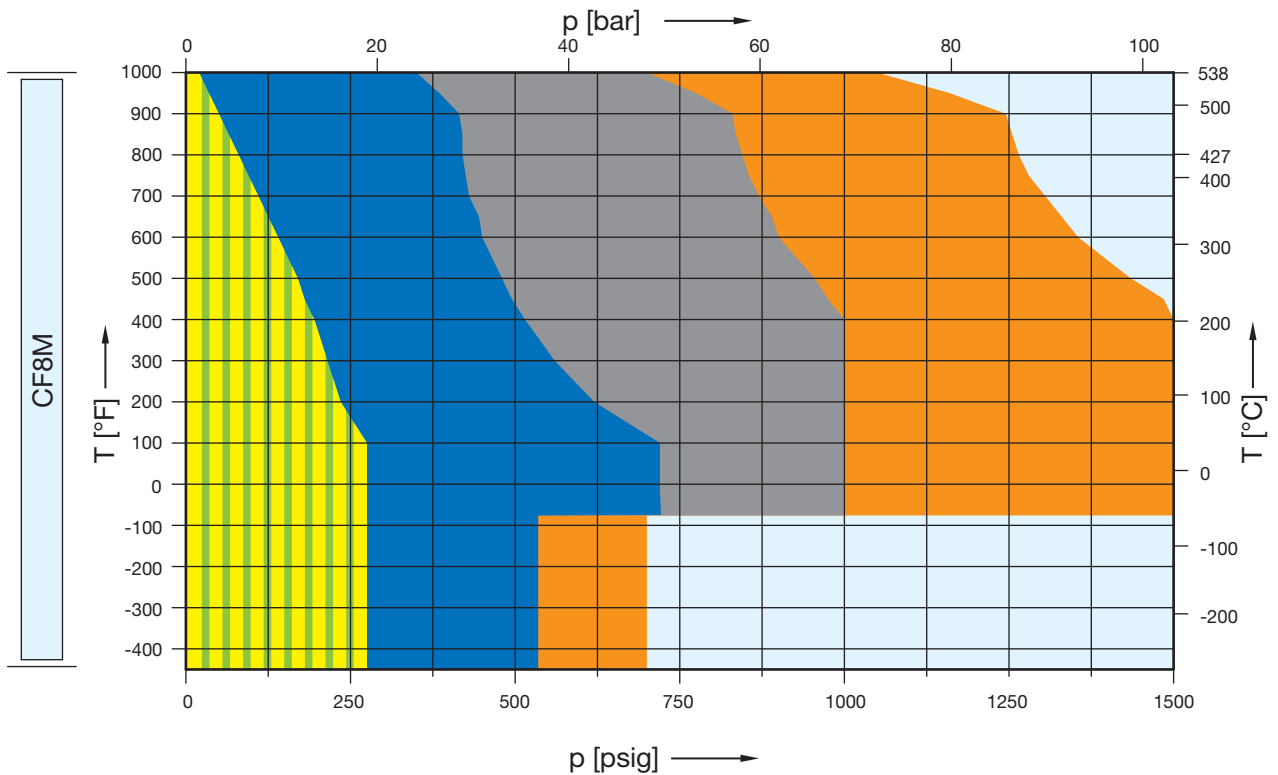

## Article numbers, dimensions and weights

### Article numbers

Valve size	3 L 4	3 L 4	4 L 6	4 L 6	4 L 6	4 L 6
Flange rating class <small>Inlet x Outlet</small>	150 x 150	300L x 150	300 x 150	600 x 150	900 x 150	1500 x 150
Actual Orifice diameter $d_0$ [mm]	53.5	53.5	53.5	53.5	53.5	53.5
Actual Orifice area $A_0$ [mm <sup>2</sup> ]	2248	2248	2248	2248	2248	2248

### Body material

	Art.-No.	5262.232 <sup>□</sup>	5262.233 <sup>□</sup>	5262.234 <sup>□</sup>	5262.235 <sup>□</sup>	5262.236 <sup>□</sup>	5262.237 <sup>□</sup>
WCB 1.0619	Art.-No.	5262.232 <sup>□</sup>	5262.233 <sup>□</sup>	5262.234 <sup>□</sup>	5262.235 <sup>□</sup>	5262.236 <sup>□</sup>	5262.237 <sup>□</sup>
CF8M 1.4408	Art.-No.	5264.242 <sup>□</sup>	5264.243 <sup>□</sup>	5264.244 <sup>□</sup>	5264.245 <sup>□</sup>	5264.246 <sup>□</sup>	-
WC6 1.7357	Art.-No.	-	-	5267.238 <sup>□</sup>	5267.239 <sup>□</sup>	5267.240 <sup>□</sup>	5267.241 <sup>□</sup>
LCB	Art.-No.	5263.540 <sup>□</sup>	5263.541 <sup>□</sup>	5263.542 <sup>□</sup>	5263.543 <sup>□</sup>	5263.544 <sup>□</sup>	5263.545 <sup>□</sup>

<sup>□</sup> Please add code for the required cap or lifting device. See below.

### Dimensions and weights

#### Metric Units

<b>Weight</b> [kg]		70.1	70.1	112.2	122	134.1	127.5
	with bellows	75.7	75.7	118.8	128.6	140.7	134.1
<b>Center to face</b> [mm]	Inlet a	156	156	179	179	197	197
	Outlet b	165	165	181	203	222	222
	s	49	49	49	57	72	72
<b>Height (H4)</b> [mm]	Standard H max.	758	758	853	853	871	871
	Bellows H max.	796	796	886	886	904	904
<b>Support brackets</b> [mm]	A	238	238	278	278	278	278
	B	140	140	160	160	160	160
	C	Ø 18	Ø 18	Ø 18	Ø 18	Ø 18	Ø 18
	D	206	206	262	262	280	280
	E	25	25	25	25	25	25

#### US Units

<b>Weight</b> [lbs]		154.6	154.6	247.4	269	295.7	281.1
	with bellows	166.9	166.9	262	283.6	310.2	295.7
<b>Center to face</b> [inch]	Inlet a	6 1/8	6 1/8	7 1/16	7 1/16	7 3/4	7 3/4
	Outlet b	6 1/2	6 1/2	7 1/8	8	8 3/4	8 3/4
	s	1 15/16	1 15/16	1 15/16	2 1/4	2 3/4	2 3/4
<b>Height (H4)</b> [inch]	Standard H max.	29 27/32	29 27/32	33 19/32	33 19/32	34 9/32	34 9/32
	Bellows H max.	31 11/32	31 11/32	34 7/8	34 7/8	35 19/32	35 19/32
<b>Support brackets</b> [inch]	A	9 3/8	9 3/8	10 15/16	10 15/16	10 15/16	10 15/16
	B	5 1/2	5 1/2	6 5/16	6 5/16	6 5/16	6 5/16
	C	Ø 23/32	Ø 23/32	Ø 23/32	Ø 23/32	Ø 23/32	Ø 23/32
	D	8 3/32	8 3/32	10 15/16	10 15/16	11	11
	E	31/32	31/32	31/32	31/32	31/32	31/32

### Code for lifting device

Lifting device	H2	H3	H4	H3
Bonnet	closed	closed	closed	open
WCB 1.0619, WC6 1.7357, LCB	2	3	4	5
CF8M 1.4408	2	-	4	-

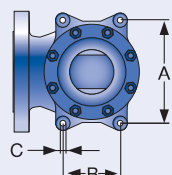

Support brackets

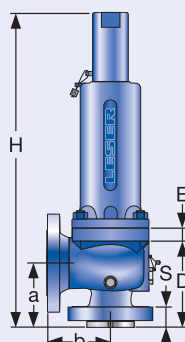

Conventional design

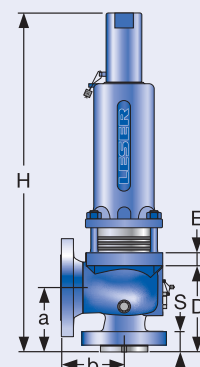

Balanced bellows design

## Pressure temperature ratings

Metric Units							
Valve size		3 L 4	3 L 4	4 L 6	4 L 6	4 L 6	4 L 6
Flange rating class <small>Inlet x Outlet</small>		150 x 150	300L x 150	300 x 150	600 x 150	900 x 150	1500 x 150
Actual Orifice diameter $d_0$ [mm]		53.5	53.5	53.5	53.5	53.5	53.5
Actual Orifice area $A_0$ [mm <sup>2</sup> ]		2248	2248	2248	2248	2248	2248
Minimum set pressure [bar] S/G/L		0.3	0.3	0.2	0.2	0.2	0.2
Minimum set pressure [bar] S/G		3.5	3.5	3.5	3.5	3.5	3.5
Balanced bellows Inconel [bar] L		3.5	3.5	6.0	6.0	6.0	6.0
<b>Body material: WCB 1.0619</b>		<b>Pressure range p [bar] S/G/L</b>					
<b>Maximum set pressure</b>	-29 to 38 °C	19.7	19.7	51.0	69.0	103.4	-
	39 to 232 °C	12.8	19.7	42.4	69.0	103.4	-
	233 to 427 °C	5.5	19.7	28.3	56.9	85.2	103.4
<b>Outlet pressure limit</b> Conventional design		19.7	19.7	19.7	19.7	19.7	19.7
<b>Outlet pressure limit</b> Balanced bellows design		6.9	6.9	11.7	11.7	11.7	11.7
<b>Body material: CF8M 1.4408</b>		<b>Pressure range p [bar] S/G/L</b>					
<b>Maximum set pressure</b>	-268 to -60 °C	19.0	19.0	36.2	36.9	48.3	-
	-59 to -29 °C	19.0	19.0	49.7	69.0	103.4	-
	-28 to 38 °C	19.0	19.0	49.7	69.0	103.4	-
	39 to 232 °C	12.4	12.4	34.1	67.2	102.4	-
	233 to 427 °C	5.5	5.5	29.0	58.3	87.2	-
	428 to 538 °C	1.4	1.4	24.1	48.3	72.4	-
<b>Outlet pressure limit</b> Conventional design		19.0	19.0	19.0	19.0	19.0	-
<b>Outlet pressure limit</b> Balanced bellows design		6.9	6.9	11.7	11.7	11.7	-
<b>Body material: WC6 1.7357</b>		<b>Pressure range p [bar] S/G/L</b>					
<b>Maximum set pressure</b>	233 to 427 °C	-	-	35.2	69.0	103.4	103.4
	428 to 538 °C	-	-	14.8	29.7	44.8	74.5
<b>Outlet pressure limit</b> Conventional design		-	-	19.7	19.7	19.7	19.7
<b>Outlet pressure limit</b> Balanced bellows design		-	-	11.7	11.7	11.7	11.7
<b>Body material: LCB</b>		<b>Pressure range p [bar] S/G/L</b>					
<b>Maximum set pressure</b>	-46 to 38 °C	18.4	18.4	48.0	96.0	144.1	240.1
	39 to 200 °C	13.8	13.8	42.5	85.1	127.6	212.7
	201 to 343 °C	8.4	8.4	36.4	72.8	109.2	182.0
<b>Outlet pressure limit</b> Conventional design		18.4	18.4	18.4	18.4	18.4	18.4
<b>Outlet pressure limit</b> Balanced bellows design		6.9	6.9	11.7	11.7	11.7	11.7

Remark: SA 352 Gr. LCB is not listed in the API 526. Pressure-Temperature Rating acc. to ASME B16.34 Table 2-1.3  
The stated Pressure-Temperature Rating are taken from ASME B16.34 Table 2-1.3 if the maximum pressure is not limited by API 526.

Due to the extended material test certificate the LESER LCB can be applied as LCC, WCB, WCC and 1.0619 with the respective pressure-temperature range as well.

## Pressure temperature ratings

US Units							
Valve size		3 L 4	3 L 4	4 L 6	4 L 6	4 L 6	4 L 6
Flange rating class <small>Inlet x Outlet</small>		150 x 150	300L x 150	300 x 150	600 x 150	900 x 150	1500 x 150
Actual Orifice diameter $d_0$ [inch]		2.11	2.11	2.11	2.11	2.11	2.11
Actual Orifice area $A_0$ [inch <sup>2</sup> ]		3.48	3.48	3.48	3.48	3.48	3.48
Minimum set pressure [psig] S/G/L		4.0	4.0	3.0	3.0	3.0	3.0
Minimum set pressure [psig] S/G		50.8	50.8	50.8	50.8	50.8	50.8
Balanced bellows Inconel [psig] L		50.8	50.8	87.0	87.0	87.0	87.0
<b>Body material: WCB 1.0619</b>		<b>Pressure range p [psig] S/G/L</b>					
<b>Maximum set pressure</b>	-20 to 100 °F	285	285	740	1000	1500	-
	101 to 450 °F	185	285	615	1000	1500	-
	451 to 800 °F	80	285	410	825	1235	1500
<b>Outlet pressure limit</b> Conventional design		285	285	285	285	285	285
<b>Outlet pressure limit</b> Balanced bellows design		100	100	170	170	170	170
<b>Body material: CF8M 1.4408</b>		<b>Pressure range p [psig] S/G/L</b>					
<b>Maximum set pressure</b>	-450 to -76 °F	275	275	535	535	700	-
	-75 to -21 °F	275	275	720	1000	1500	-
	-20 to 100 °F	275	275	720	1000	1500	-
	101 to 450 °F	180	180	495	975	1485	-
	451 to 800 °F	80	80	420	845	1265	-
	801 to 1000 °F	20	20	350	700	1050	-
<b>Outlet pressure limit</b> Conventional design		275	275	275	275	275	-
<b>Outlet pressure limit</b> Balanced bellows design		100	100	170	170	170	-
<b>Body material: WC6 1.7357</b>		<b>Pressure range p [psig] S/G/L</b>					
<b>Maximum set pressure</b>	451 to 800 °F	-	-	510	1000	1500	1500
	801 to 1000 °F	-	-	215	430	650	1080
<b>Outlet pressure limit</b> Conventional design		-	-	285	285	285	285
<b>Outlet pressure limit</b> Balanced bellows design		-	-	170	170	170	170
<b>Body material: LCB</b>		<b>Pressure range p [psig] S/G/L</b>					
<b>Maximum set pressure</b>	-50 to 100 °F	265	265	695	1395	2090	3480
	101 to 400 °F	200	200	615	1230	1845	3075
	401 to 650 °F	125	125	535	1065	1600	2665
<b>Outlet pressure limit</b> Conventional design		265	265	265	265	265	265
<b>Outlet pressure limit</b> Balanced bellows design		100	100	170	170	170	170

Remark: SA 352 Gr. LCB is not listed in the API 526. Pressure-Temperature Rating acc. to ASME B16.34 Table 2-1.3  
The stated Pressure-Temperature Rating are taken from ASME B16.34 Table 2-1.3 if the maximum pressure is not limited by API 526.

Due to the extended material test certificate the LESER LCB can be applied as LCC, WCB, WCC and 1.0619 with the respective pressure-temperature range as well.

## Selection chart

	150 x 150	300L x 150	300 x 150	600 x 150	900 x 150	1500 x 150	2500 x 300
WCB	5262.580X	See 300 x 150	5262.581X	5262.582X	5262.583X	-	-
WC6	-	See 300 x 150	5267.584X	5267.585X	5267.586X	-	-

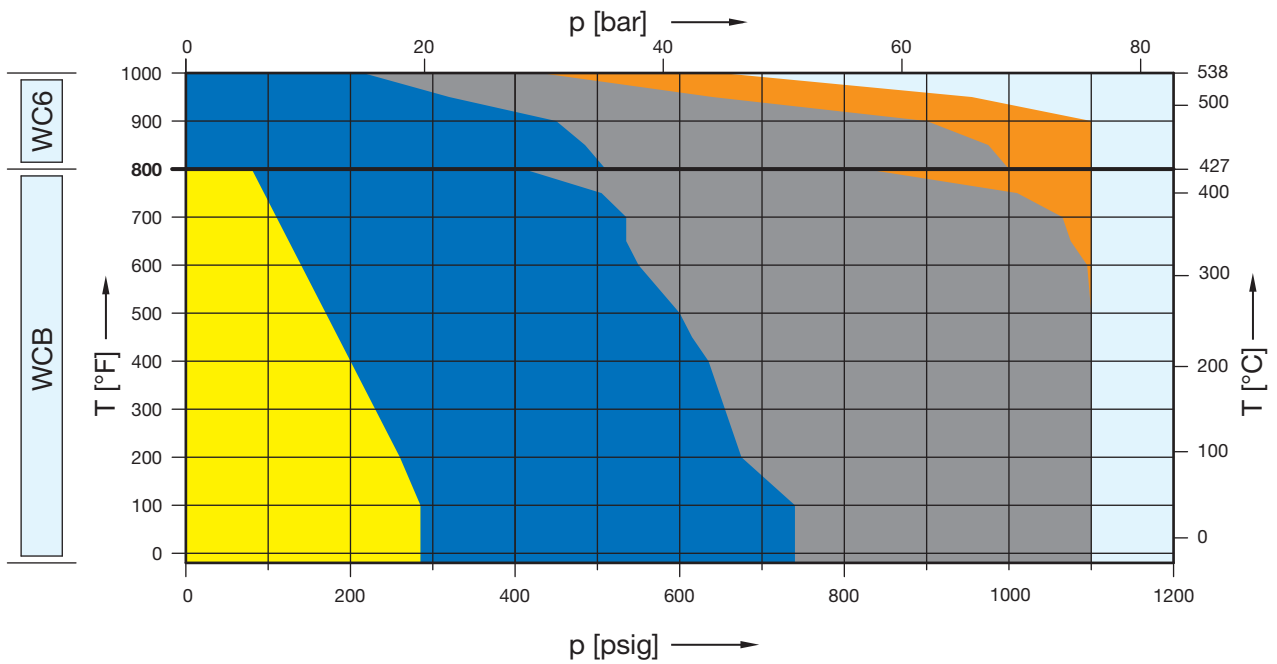

	150 x 150	300L x 150	300 x 150	600 x 150	900 x 150	1500 x 150	2500 x 300
CF8M	5264.587X	See 300 x 150	5264.588X	5264.589X	-	-	-

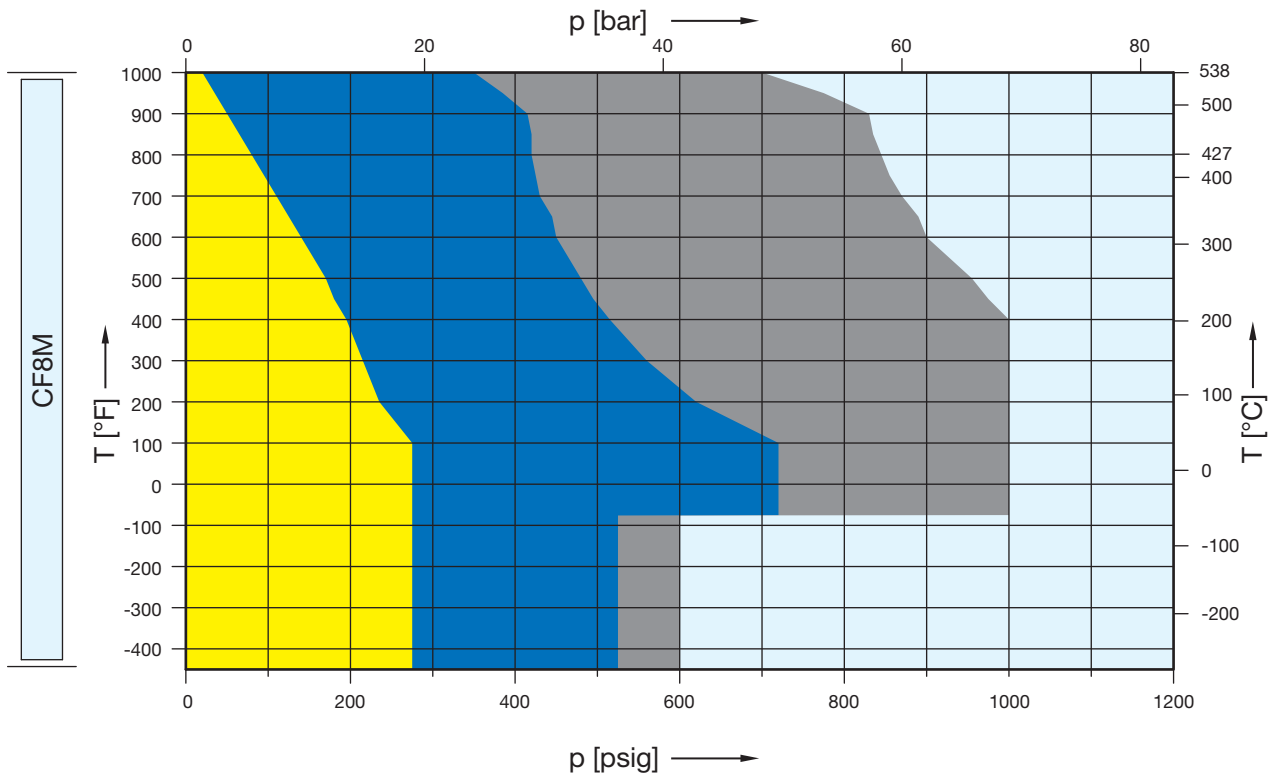

## Article numbers, dimensions and weights

### Article numbers

Valve size	4 M 6	4 M 6	4 M 6	4 M 6	4 M 6
Flange rating class Inlet x Outlet	150 x 150	300L x 150	300 x 150	600 x 150	900 x 150
Actual Orifice diameter $d_0$ [mm]	60.3	60.3	60.3	60.3	60.3
Actual Orifice area $A_0$ [mm <sup>2</sup> ]	2856	2856	2856	2856	2856

### Body material

WCB 1.0619	Art.-No.	5262.580 <sup>□</sup>	Use 4 M 6 300 x 150	5262.581 <sup>□</sup>	5262.582 <sup>□</sup>	5262.583 <sup>□</sup>
CF8M 1.4408	Art.-No.	5264.587 <sup>□</sup>		5264.588 <sup>□</sup>	5264.589 <sup>□</sup>	-
WC6 1.7357	Art.-No.	-		5267.584 <sup>□</sup>	5267.585 <sup>□</sup>	5267.586 <sup>□</sup>
LCB	Art.-No.	5263.546 <sup>□</sup>		5263.547 <sup>□</sup>	5263.548 <sup>□</sup>	5263.549 <sup>□</sup>

<sup>□</sup> Please add code for the required cap or lifting device. See below.

### Dimensions and weights

#### Metric Units

<b>Weight</b> [kg]		112.1	Use 4 M 6 300 x 150	112.1	122	134.1
	with bellows	118.7		118.7	128.6	140.7
<b>Center to face</b> [mm]	Inlet a	178		178	178	197
	Outlet b	184		184	203	222
	s	48		48	56	72
<b>Height (H4)</b> [mm]	Standard H max.	852	852	852	871	
	Bellows H max.	885	885	885	904	
<b>Support brackets</b> [mm]	A	278	278	278	278	
	B	160	160	160	160	
	C	Ø 18	Ø 18	Ø 18	Ø 18	
	D	260	260	260	280	
	E	25	25	25	25	

#### US Units

<b>Weight</b> [lbs]		247.2	Use 4 M 6 300 x 150	247.2	269	295.7
	with bellows	261.7		261.7	283.6	310.2
<b>Center to face</b> [inch]	Inlet a	7		7	7	7 <sup>3</sup> / <sub>4</sub>
	Outlet b	7 <sup>1</sup> / <sub>4</sub>		7 <sup>1</sup> / <sub>4</sub>	8	8 <sup>3</sup> / <sub>4</sub>
	s	1 <sup>7</sup> / <sub>8</sub>		1 <sup>7</sup> / <sub>8</sub>	2 <sup>3</sup> / <sub>16</sub>	2 <sup>3</sup> / <sub>4</sub>
<b>Height (H4)</b> [inch]	Standard H max.	33 <sup>17</sup> / <sub>32</sub>	33 <sup>17</sup> / <sub>32</sub>	33 <sup>17</sup> / <sub>32</sub>	33 <sup>17</sup> / <sub>32</sub>	
	Bellows H max.	34 <sup>27</sup> / <sub>32</sub>	34 <sup>27</sup> / <sub>32</sub>	34 <sup>27</sup> / <sub>32</sub>	34 <sup>27</sup> / <sub>32</sub>	
<b>Support brackets</b> [inch]	A	10 <sup>15</sup> / <sub>16</sub>	10 <sup>15</sup> / <sub>16</sub>	10 <sup>15</sup> / <sub>16</sub>	10 <sup>15</sup> / <sub>16</sub>	
	B	6 <sup>5</sup> / <sub>16</sub>	6 <sup>5</sup> / <sub>16</sub>	6 <sup>5</sup> / <sub>16</sub>	6 <sup>5</sup> / <sub>16</sub>	
	C	Ø <sup>23</sup> / <sub>32</sub>	Ø <sup>23</sup> / <sub>32</sub>	Ø <sup>23</sup> / <sub>32</sub>	Ø <sup>23</sup> / <sub>32</sub>	
	D	10 <sup>1</sup> / <sub>4</sub>	10 <sup>1</sup> / <sub>4</sub>	10 <sup>1</sup> / <sub>4</sub>	11	
	E	<sup>3</sup> / <sub>32</sub>	<sup>3</sup> / <sub>32</sub>	<sup>3</sup> / <sub>32</sub>	<sup>3</sup> / <sub>32</sub>	

### Code for lifting device

Lifting device	H2	H3	H4	H3
Bonnet	closed	closed	closed	open
WCB 1.0619, WC6 1.7357, LCB	2	3	4	5
CF8M 1.4408	2	-	4	-

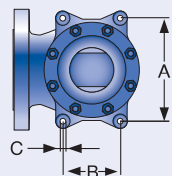

Support brackets

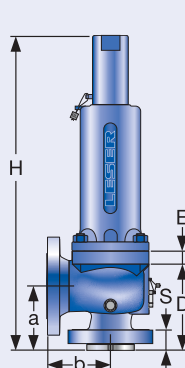

Conventional design

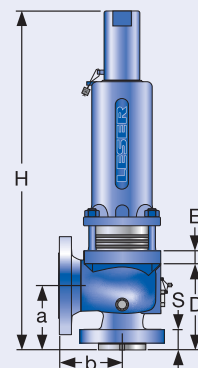

Balanced bellows design

## Pressure temperature ratings

Metric Units						
Valve size		4 M 6	4 M 6	4 M 6	4 M 6	4 M 6
Flange rating class <small>Inlet x Outlet</small>		150 x 150	300L x 150	300 x 150	600 x 150	900 x 150
Actual Orifice diameter $d_0$ [mm]		60.3	60.3	60.3	60.3	60.3
Actual Orifice area $A_0$ [mm <sup>2</sup> ]		2846	2846	2846	2846	2846
Minimum set pressure [bar] S/G/L		0.2	0.2	0.2	0.2	0.2
Minimum set pressure [bar] S/G		2.6	2.6	2.6	6.3	10.5
Balanced bellows Inconel [bar] L		2.2	2.2	2.2	10.5	10.5
<b>Body material: WCB 1.0619</b>		<b>Pressure range p [bar] S/G/L</b>				
<b>Maximum set pressure</b>	-29 to 38 °C	19.7	Use 4 M 6 300 x 150	51.0	75.9	-
	39 to 232 °C	12.8		42.4	75.9	-
	233 to 427 °C	5.5		28.3	56.9	75.9
<b>Outlet pressure limit</b> Conventional design		19.7		19.7	19.7	19.7
<b>Outlet pressure limit</b> Balanced bellows design		5.5		11.0	11.0	11.0
<b>Body material: CF8M 1.4408</b>		<b>Pressure range p [bar] S/G/L</b>				
<b>Maximum set pressure</b>	-268 to -60 °C	19.0	Use 4 M 6 300 x 150	36.2	41.4	-
	-59 to -29 °C	19.0		49.7	69.0	-
	-28 to 38 °C	19.0		49.7	69.0	-
	39 to 232 °C	12.4		34.1	67.2	-
	233 to 427 °C	5.5		29.0	58.3	-
	428 to 538 °C	1.4		24.1	48.3	-
<b>Outlet pressure limit</b> Conventional design		19.0		19.0	19.0	-
<b>Outlet pressure limit</b> Balanced bellows design		5.5		11.0	11.0	-
<b>Body material: WC6 1.7357</b>		<b>Pressure range p [bar] S/G/L</b>				
<b>Maximum set pressure</b>	233 to 427 °C	-	Use 4 M 6 300 x 150	35.2	69.0	75.9
	428 to 538 °C	-		14.8	29.7	44.8
<b>Outlet pressure limit</b> Conventional design		-		19.7	19.7	19.7
<b>Outlet pressure limit</b> Balanced bellows design		-		11.0	11.0	11.0
<b>Body material: LCB</b>		<b>Pressure range p [bar] S/G/L</b>				
<b>Maximum set pressure</b>	-46 to 38 °C	18.4	Use 4 M 6 300 x 150	48.0	96.0	144.1
	39 to 200 °C	13.8		42.5	85.1	127.6
	201 to 343 °C	8.4		36.4	72.8	109.2
<b>Outlet pressure limit</b> Conventional design		18.4		18.4	18.4	18.4
<b>Outlet pressure limit</b> Balanced bellows design		5.5		11.0	11.0	11.0

Remark: SA 352 Gr. LCB is not listed in the API 526. Pressure-Temperature Rating acc. to ASME B16.34 Table 2-1.3  
The stated Pressure-Temperature Rating are taken from ASME B16.34 Table 2-1.3 if the maximum pressure is not limited by API 526.

Due to the extended material test certificate the LESER LCB can be applied as LCC, WCB, WCC and 1.0619 with the respective pressure-temperature range as well.



## Pressure temperature ratings

US Units						
Valve size		4 M 6	4 M 6	4 M 6	4 M 6	4 M 6
Flange rating class <small>Inlet x Outlet</small>		150 x 150	300L x 150	300 x 150	600 x 150	900 x 150
Actual Orifice diameter $d_0$ [inch]		2.37	2.37	2.37	2.37	2.37
Actual Orifice area $A_0$ [inch <sup>2</sup> ]		4.43	4.43	4.43	4.43	4.43
Minimum set pressure [psig] S/G/L		3.0	3.0	3.0	3.0	3.0
Minimum set pressure [psig] S/G		37.7	37.7	37.7	91.4	152.3
Balanced bellows Inconel [psig] L		31.9	31.9	31.9	152.3	152.3
<b>Body material: WCB 1.0619</b>		<b>Pressure range p [psig] S/G/L</b>				
<b>Maximum set pressure</b>	-20 to 100 °F	285	Use 4 M 6 300 x 150	740	1100	-
	101 to 450 °F	185		615	1100	-
	451 to 800 °F	80		410	825	1100
<b>Outlet pressure limit</b> Conventional design		285		285	285	285
<b>Outlet pressure limit</b> Balanced bellows design		80		160	160	160
<b>Body material: CF8M 1.4408</b>		<b>Pressure range p [psig] S/G/L</b>				
<b>Maximum set pressure</b>	-450 to -76 °F	275	Use 4 M 6 300 x 150	525	600	-
	-75 to -21 °F	275		720	1000	-
	-20 to 100 °F	275		720	1000	-
	101 to 450 °F	180		495	975	-
	451 to 800 °F	80		420	845	-
	801 to 1000 °F	20		350	700	-
<b>Outlet pressure limit</b> Conventional design		275		275	275	-
<b>Outlet pressure limit</b> Balanced bellows design		80		160	160	-
<b>Body material: WC6 1.7357</b>		<b>Pressure range p [psig] S/G/L</b>				
<b>Maximum set pressure</b>	451 to 800 °F	-	Use 4 M 6 300 x 150	510	1000	1100
	801 to 1000 °F	-		215	430	650
<b>Outlet pressure limit</b> Conventional design		-		285	285	285
<b>Outlet pressure limit</b> Balanced bellows design		-		160	160	160
<b>Body material: LCB</b>		<b>Pressure range p [psig] S/G/L</b>				
<b>Maximum set pressure</b>	-50 to 100 °F	265	Use 4 M 6 300 x 150	695	1395	2090
	101 to 400 °F	200		615	1230	1845
	401 to 650 °F	125		535	1065	1600
<b>Outlet pressure limit</b> Conventional design		265		265	265	265
<b>Outlet pressure limit</b> Balanced bellows design		80		160	160	160

Remark: SA 352 Gr. LCB is not listed in the API 526. Pressure-Temperature Rating acc. to ASME B16.34 Table 2-1.3  
The stated Pressure-Temperature Rating are taken from ASME B16.34 Table 2-1.3 if the maximum pressure is not limited by API 526.

Due to the extended material test certificate the LESER LCB can be applied as LCC, WCB, WCC and 1.0619 with the respective pressure-temperature range as well.



## Selection chart

	150 x 150	300L x 150	300 x 150	600 x 150	900 x 150	1500 x 150	2500 x 300
WCB	5262.590X	See 300 x 150	5262.591X	5262.592X	5262.593X	-	-
WC6	-	See 300 x 150	5267.594X	5267.595X	5267.596X	-	-

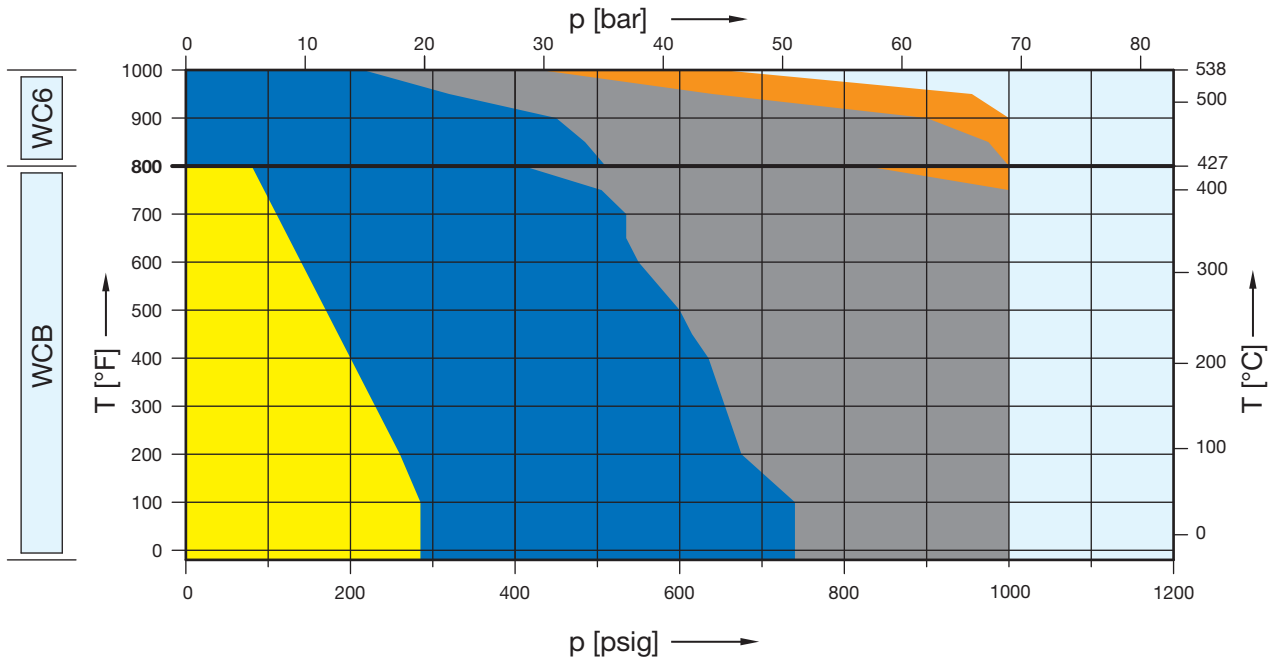

	150 x 150	300L x 150	300 x 150	600 x 150	900 x 150	1500 x 150	2500 x 300
CF8M	5264.597X	See 300 x 150	5264.598X	5264.599X	-	-	-

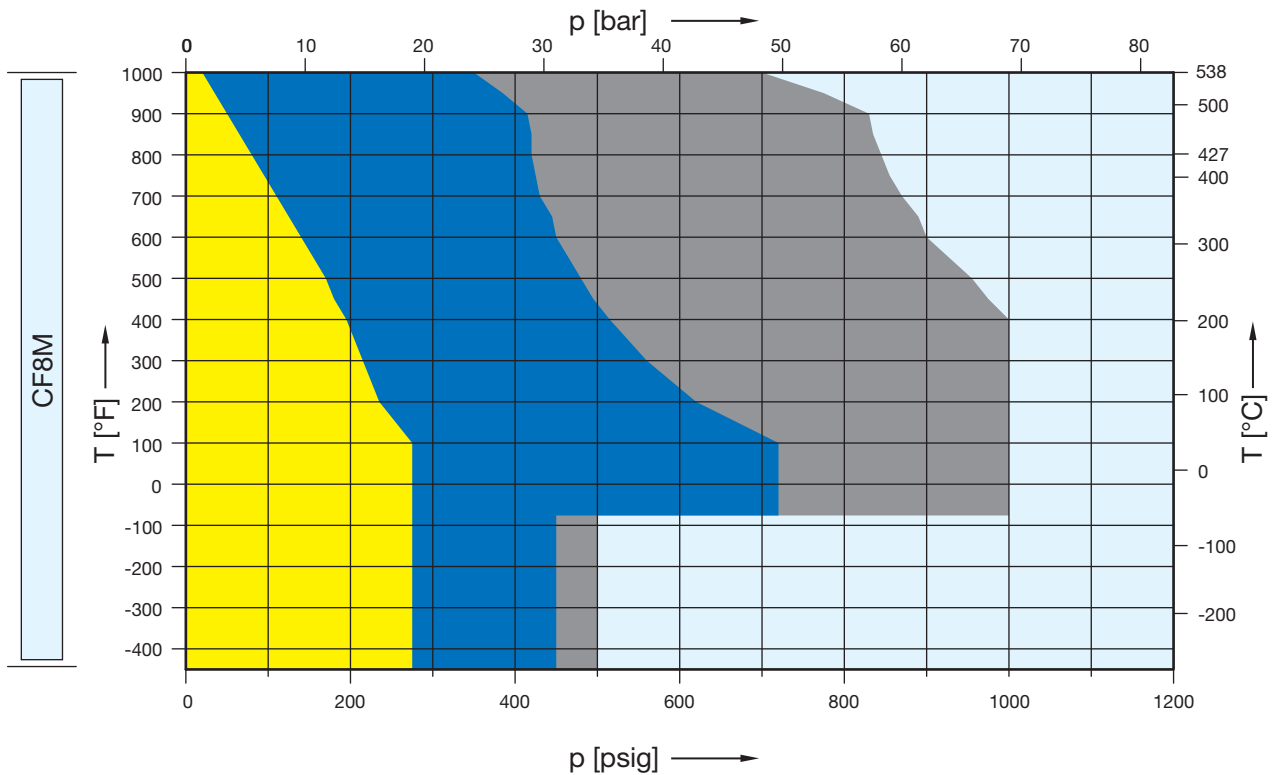

## Article numbers, dimensions and weights

### Article numbers

Valve size	4 N 6	4 N 6	4 N 6	4 N 6	4 N 6
Flange rating class $d_{inlet} \times d_{outlet}$	150 x 150	300L x 150	300 x 150	600 x 150	900 x 150
Actual Orifice diameter $d_0$ [mm]	66.0	66.0	66.0	66.0	66.0
Actual Orifice area $A_0$ [mm <sup>2</sup> ]	3421	3421	3421	3421	3421

### Body material

Material	Art.-No.	5262.590 <sup>□</sup>	Use 4 N 6 300 x 150	5262.591 <sup>□</sup>	5262.592 <sup>□</sup>	5262.593 <sup>□</sup>
WCB 1.0619	Art.-No.	5262.590 <sup>□</sup>		5262.591 <sup>□</sup>	5262.592 <sup>□</sup>	5262.593 <sup>□</sup>
CF8M 1.4408	Art.-No.	5264.597 <sup>□</sup>		5264.598 <sup>□</sup>	5264.599 <sup>□</sup>	-
WC6 1.7357	Art.-No.	-		5267.594 <sup>□</sup>	5267.595 <sup>□</sup>	5267.596 <sup>□</sup>
LCB	Art.-No.	5263.550 <sup>□</sup>		5263.551 <sup>□</sup>	5263.552 <sup>□</sup>	5263.553 <sup>□</sup>

<sup>□</sup> Please add code for the required cap or lifting device. See below.

### Dimensions and weights

#### Metric Units

Weight [kg]		128.6	Use 4 N 6 300 x 150	128.6	134.1	134.1
with bellows		135.2		135.2	140.7	140.7
Center to face [mm]	Inlet a	197		197	197	197
	Outlet b	210		210	222	222
	s	48		48	72	72
Height (H4) [mm]	Standard H max.	871		871	871	871
	Bellows H max.	904		904	904	904
Support brackets [mm]	A	278		278	278	278
	B	160		160	160	160
	C	Ø 18		Ø 18	Ø 18	Ø 18
	D	280		280	280	280
	E	25		25	25	25

#### US Units

Weight [lbs]		283.6	Use 4 N 6 300 x 150	283.6	295.7	295.7
with bellows		298.1		298.1	310.2	310.2
Center to face [inch]	Inlet a	7 <sup>3</sup> / <sub>4</sub>		7 <sup>3</sup> / <sub>4</sub>	7 <sup>3</sup> / <sub>4</sub>	7 <sup>3</sup> / <sub>4</sub>
	Outlet b	8 <sup>1</sup> / <sub>4</sub>		8 <sup>1</sup> / <sub>4</sub>	8 <sup>3</sup> / <sub>4</sub>	8 <sup>3</sup> / <sub>4</sub>
	s	1 <sup>7</sup> / <sub>8</sub>		1 <sup>7</sup> / <sub>8</sub>	2 <sup>3</sup> / <sub>4</sub>	2 <sup>3</sup> / <sub>4</sub>
Height (H4) [inch]	Standard H max.	34 <sup>9</sup> / <sub>32</sub>		34 <sup>9</sup> / <sub>32</sub>	34 <sup>9</sup> / <sub>32</sub>	34 <sup>9</sup> / <sub>32</sub>
	Bellows H max.	35 <sup>19</sup> / <sub>32</sub>		35 <sup>19</sup> / <sub>32</sub>	35 <sup>19</sup> / <sub>32</sub>	35 <sup>19</sup> / <sub>32</sub>
Support brackets [inch]	A	10 <sup>15</sup> / <sub>16</sub>		10 <sup>15</sup> / <sub>16</sub>	10 <sup>15</sup> / <sub>16</sub>	10 <sup>15</sup> / <sub>16</sub>
	B	6 <sup>5</sup> / <sub>16</sub>		6 <sup>5</sup> / <sub>16</sub>	6 <sup>5</sup> / <sub>16</sub>	6 <sup>5</sup> / <sub>16</sub>
	C	Ø <sup>23</sup> / <sub>32</sub>		Ø <sup>23</sup> / <sub>32</sub>	Ø <sup>23</sup> / <sub>32</sub>	Ø <sup>23</sup> / <sub>32</sub>
	D	11		11	11	11
	E	<sup>31</sup> / <sub>32</sub>		<sup>31</sup> / <sub>32</sub>	<sup>31</sup> / <sub>32</sub>	<sup>31</sup> / <sub>32</sub>

### Code for lifting device

Lifting device	H2	H3	H4	H3
Bonnet	closed	closed	closed	open
WCB 1.0619, WC6 1.7357, LCB	2	3	4	5
CF8M 1.4408	2	-	4	-

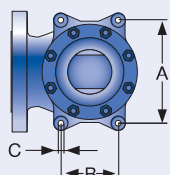

Support brackets

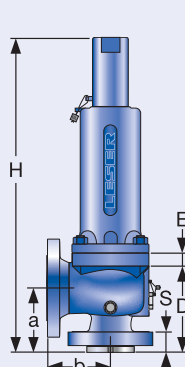

Conventional design

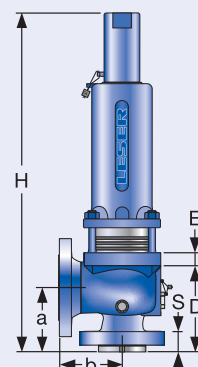

Balanced bellows design

## Pressure temperature ratings

Metric Units						
Valve size		4 N 6	4 N 6	4 N 6	4 N 6	4 N 6
Flange rating class <small>Inlet x Outlet</small>		150 x 150	300L x 150	300 x 150	600 x 150	900 x 150
Actual Orifice diameter $d_0$ [mm]		66.0	66.0	66.0	66.0	66.0
Actual Orifice area $A_0$ [mm <sup>2</sup> ]		3421	3421	3421	3421	3421
Minimum set pressure [bar] S/G/L		0.2	0.2	0.2	0.2	0.2
Minimum set pressure [bar] S/G		1.8	1.8	1.8	5.2	5.2
Balanced bellows Inconel [bar] L		1.8	1.8	1.8	8.9	8.9
<b>Body material: WCB 1.0619</b>		<b>Pressure range p [bar] S/G/L</b>				
<b>Maximum set pressure</b>	-29 to 38 °C	19.7	Use 4 N 6 300 x 150	51.0	69.0	-
	39 to 232 °C	12.8		42.4	69.0	-
	233 to 427 °C	5.5		28.3	56.9	69.0
<b>Outlet pressure limit</b> Conventional design		19.7		19.7	19.7	19.7
<b>Outlet pressure limit</b> Balanced bellows design		5.5		11.0	11.0	11.0
<b>Body material: CF8M 1.4408</b>		<b>Pressure range p [bar] S/G/L</b>				
<b>Maximum set pressure</b>	-268 to -60 °C	19.0	Use 4 N 6 300 x 150	31.0	34.5	-
	-59 to -29 °C	19.0		49.7	69.0	-
	-28 to 38 °C	19.0		49.7	69.0	-
	39 to 232 °C	12.4		34.1	67.2	-
	233 to 427 °C	5.5		29.0	58.3	-
	428 to 538 °C	1.4		24.1	48.3	-
<b>Outlet pressure limit</b> Conventional design		19.0		19.0	19.0	-
<b>Outlet pressure limit</b> Balanced bellows design		5.5		11.0	11.0	-
<b>Body material: WC6 1.7357</b>		<b>Pressure range p [bar] S/G/L</b>				
<b>Maximum set pressure</b>	233 to 427 °C	-	Use 4 N 6 300 x 150	35.2	69.0	69.0
	428 to 538 °C	-		14.8	29.7	44.8
<b>Outlet pressure limit</b> Conventional design		-		19.7	19.7	19.7
<b>Outlet pressure limit</b> Balanced bellows design		-		11.0	11.0	11.0
<b>Body material: LCB</b>		<b>Pressure range p [bar] S/G/L</b>				
<b>Maximum set pressure</b>	-46 to 38 °C	18.4	Use 4 N 6 300 x 150	48.0	96.0	144.1
	39 to 200 °C	13.8		42.5	85.1	127.6
	201 to 343 °C	8.4		36.4	72.8	109.2
<b>Outlet pressure limit</b> Conventional design		18.4		18.4	18.4	18.4
<b>Outlet pressure limit</b> Balanced bellows design		5.5		11.0	11.0	11.0

Remark: SA 352 Gr. LCB is not listed in the API 526. Pressure-Temperature Rating acc. to ASME B16.34 Table 2-1.3  
The stated Pressure-Temperature Rating are taken from ASME B16.34 Table 2-1.3 if the maximum pressure is not limited by API 526.

Due to the extended material test certificate the LESER LCB can be applied as LCC, WCB, WCC and 1.0619 with the respective pressure-temperature range as well.

## Pressure temperature ratings

US Units						
Valve size		4 N 6	4 N 6	4 N 6	4 N 6	4 N 6
Flange rating class <small>Inlet x Outlet</small>		150 x 150	300L x 150	300 x 150	600 x 150	900 x 150
Actual Orifice diameter $d_0$ [inch]		2.60	2.60	2.60	2.60	2.60
Actual Orifice area $A_0$ [inch <sup>2</sup> ]		5.30	5.30	5.30	5.30	5.30
Minimum set pressure [psig] S/G/L		3.0	3.0	3.0	3.0	3.0
Minimum set pressure [psig] S/G		26.1	26.1	26.1	75.4	75.4
Balanced bellows Inconel [psig] L		26.1	26.1	26.1	129.0	129.0
<b>Body material: WCB 1.0619</b>		<b>Pressure range p [psig] S/G/L</b>				
<b>Maximum set pressure</b>	-20 to 100 °F	285	Use 4 N 6 300 x 150	740	1000	-
	101 to 450 °F	185		615	1000	-
	451 to 800 °F	80		410	825	1000
<b>Outlet pressure limit</b> Conventional design		285		285	285	285
<b>Outlet pressure limit</b> Balanced bellows design		80		160	160	160
<b>Body material: CF8M 1.4408</b>		<b>Pressure range p [psig] S/G/L</b>				
<b>Maximum set pressure</b>	-450 to -76 °F	275	Use 4 N 6 300 x 150	450	500	-
	-75 to -21 °F	275		720	1000	-
	-20 to 100 °F	275		720	1000	-
	101 to 450 °F	180		495	975	-
	451 to 800 °F	80		420	845	-
	801 to 1000 °F	20		350	700	-
<b>Outlet pressure limit</b> Conventional design		275		275	275	-
<b>Outlet pressure limit</b> Balanced bellows design		80		160	160	-
<b>Body material: WC6 1.7357</b>		<b>Pressure range p [psig] S/G/L</b>				
<b>Maximum set pressure</b>	451 to 800 °F	-	Use 4 N 6 300 x 150	510	1000	1000
	801 to 1000 °F	-		215	430	650
<b>Outlet pressure limit</b> Conventional design		-		285	285	285
<b>Outlet pressure limit</b> Balanced bellows design		-		160	160	160
<b>Body material: LCB</b>		<b>Pressure range p [psig] S/G/L</b>				
<b>Maximum set pressure</b>	-50 to 100 °F	265	Use 4 N 6 300 x 150	695	1395	2090
	101 to 400 °F	200		615	1230	1845
	401 to 650 °F	125		535	1065	1600
<b>Outlet pressure limit</b> Conventional design		265		265	265	265
<b>Outlet pressure limit</b> Balanced bellows design		80		160	160	160

Remark: SA 352 Gr. LCB is not listed in the API 526. Pressure-Temperature Rating acc. to ASME B16.34 Table 2-1.3  
The stated Pressure-Temperature Rating are taken from ASME B16.34 Table 2-1.3 if the maximum pressure is not limited by API 526.

Due to the extended material test certificate the LESER LCB can be applied as LCC, WCB, WCC and 1.0619 with the respective pressure-temperature range as well.

## Selection chart

	150 x 150	300L x 150	300 x 150	600 x 150	900 x 150	1500 x 150	2500 x 300
WCB	5262.645X	5262.646X	5262.647X	5262.648X	5262.649X	-	-
WC6	-	-	5267.650X	5267.651X	5267.652X	-	-

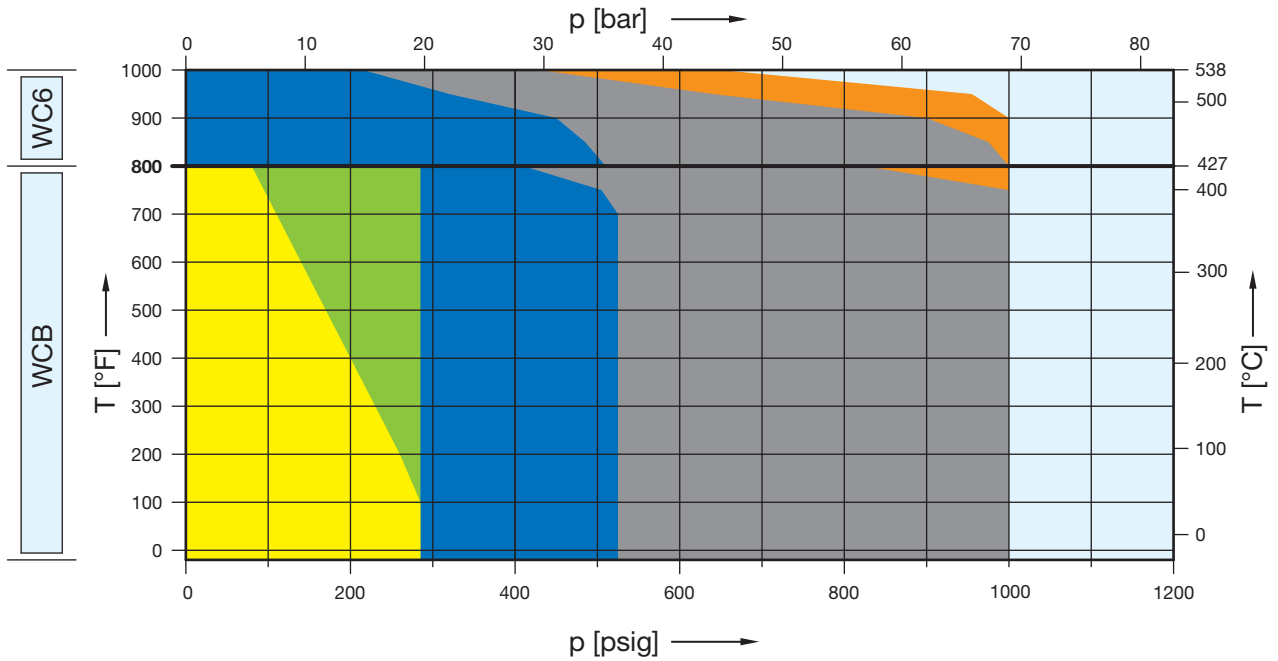

	150 x 150	300L x 150	300 x 150	600 x 150	900 x 150	1500 x 150	2500 x 300
CF8M	5264.653X	5264.654X	5264.655X	5264.656X	-	-	-

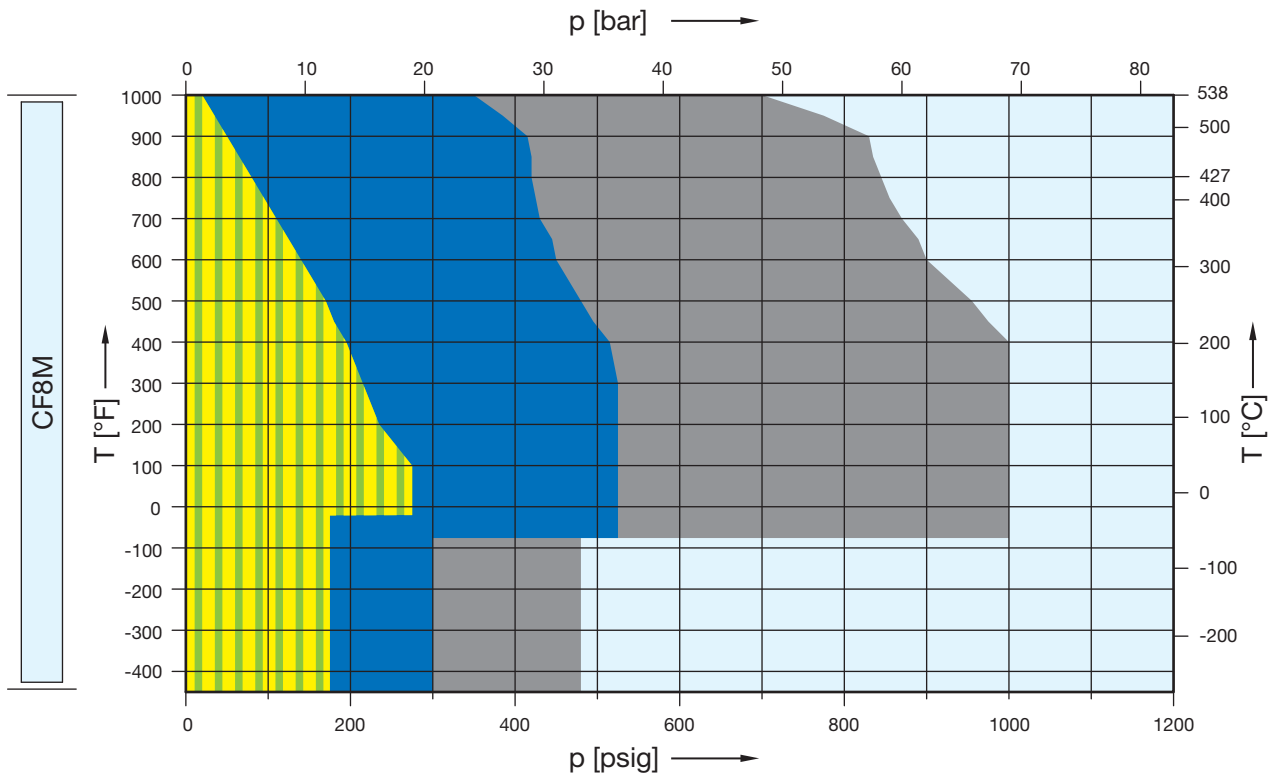

## Article numbers, dimensions and weights

### Article numbers

Valve size	4 P 6	4 P 6	4 P 6	4 P 6	4 P 6
Flange rating class <small>Inlet x Outlet</small>	150 x 150	300L x 150	300 x 150	600 x 150	900 x 150
Actual Orifice diameter $d_0$ [mm]	80.0	80.0	80.0	80.0	80.0
Actual Orifice area $A_0$ [mm <sup>2</sup> ]	5027	5027	5027	5027	5027
<b>Body material</b>					
WCB 1.0619	Art.-No. <b>5262.645<sup>□</sup></b>	<b>5262.646<sup>□</sup></b>	<b>5262.647<sup>□</sup></b>	<b>5262.648<sup>□</sup></b>	<b>5262.649<sup>□</sup></b>
CF8M 1.4408	Art.-No. <b>5264.653<sup>□</sup></b>	<b>5264.654<sup>□</sup></b>	<b>5264.655<sup>□</sup></b>	<b>5264.656<sup>□</sup></b>	-
WC6 1.7357	Art.-No. -	-	<b>5267.650<sup>□</sup></b>	<b>5267.651<sup>□</sup></b>	<b>5267.652<sup>□</sup></b>
LCB	Art.-No. <b>5263.554<sup>□</sup></b>	<b>5263.555<sup>□</sup></b>	<b>5263.556<sup>□</sup></b>	<b>5263.557<sup>□</sup></b>	<b>5263.558<sup>□</sup></b>

<sup>□</sup> Please add code for the required cap or lifting device. See below.

### Dimensions and weights

#### Metric Units

<b>Weight</b> [kg]		107.7	107.7	164	164	164
	with bellows	114.8	114.8	172	172	172
<b>Center to face</b> [mm]	Inlet a	181	181	225	225	225
	Outlet b	229	229	254	254	254
	s	48	48	62	62	62
<b>Height (H4)</b> [mm]	Standard H max.	855	855	1079	1079	1079
	Bellows H max.	888	888	1138	1138	1138
<b>Support brackets</b> [mm]	A	278	278	370	370	370
	B	160	160	210	210	210
	C	Ø 18	Ø 18	Ø 18	Ø 18	Ø 18
	D	262	262	306	306	306
	E	25	25	25	25	25

#### US Units

<b>Weight</b> [lbs]		237.5	237.5	361.6	361.6	361.6
	with bellows	253.1	253.1	379.3	379.3	379.3
<b>Center to face</b> [inch]	Inlet a	7 <sup>1</sup> / <sub>8</sub>	7 <sup>1</sup> / <sub>8</sub>	8 <sup>7</sup> / <sub>8</sub>	8 <sup>7</sup> / <sub>8</sub>	8 <sup>7</sup> / <sub>8</sub>
	Outlet b	9	9	10	10	10
	s	1 <sup>7</sup> / <sub>8</sub>	1 <sup>7</sup> / <sub>8</sub>	2 <sup>7</sup> / <sub>16</sub>	2 <sup>7</sup> / <sub>16</sub>	2 <sup>7</sup> / <sub>16</sub>
<b>Height (H4)</b> [inch]	Standard H max.	33 <sup>21</sup> / <sub>32</sub>	33 <sup>21</sup> / <sub>32</sub>	42 <sup>1</sup> / <sub>2</sub>	42 <sup>1</sup> / <sub>2</sub>	42 <sup>1</sup> / <sub>2</sub>
	Bellows H max.	34 <sup>31</sup> / <sub>32</sub>	34 <sup>31</sup> / <sub>32</sub>	44 <sup>13</sup> / <sub>16</sub>	44 <sup>13</sup> / <sub>16</sub>	44 <sup>13</sup> / <sub>16</sub>
<b>Support brackets</b> [inch]	A	10 <sup>15</sup> / <sub>16</sub>	10 <sup>15</sup> / <sub>16</sub>	14 <sup>9</sup> / <sub>16</sub>	14 <sup>9</sup> / <sub>16</sub>	14 <sup>9</sup> / <sub>16</sub>
	B	6 <sup>5</sup> / <sub>16</sub>	6 <sup>5</sup> / <sub>16</sub>	8 <sup>9</sup> / <sub>32</sub>	8 <sup>9</sup> / <sub>32</sub>	8 <sup>9</sup> / <sub>32</sub>
	C	Ø <sup>23</sup> / <sub>32</sub>	Ø <sup>23</sup> / <sub>32</sub>	Ø <sup>23</sup> / <sub>32</sub>	Ø <sup>23</sup> / <sub>32</sub>	Ø <sup>23</sup> / <sub>32</sub>
	D	10 <sup>5</sup> / <sub>16</sub>	10 <sup>5</sup> / <sub>16</sub>	12 <sup>1</sup> / <sub>16</sub>	12 <sup>1</sup> / <sub>16</sub>	12 <sup>1</sup> / <sub>16</sub>
	E	<sup>31</sup> / <sub>32</sub>	<sup>31</sup> / <sub>32</sub>	<sup>31</sup> / <sub>32</sub>	<sup>31</sup> / <sub>32</sub>	<sup>31</sup> / <sub>32</sub>

#### Code for lifting device

Lifting device	H2	H3	H4	H3
Bonnet	closed	closed	closed	open
WCB 1.0619, WC6 1.7357, LCB	2	3	4	5
CF8M 1.4408	2	-	4	-

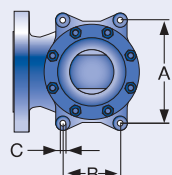

Support brackets

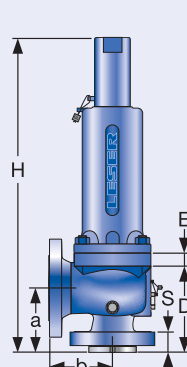

Conventional design

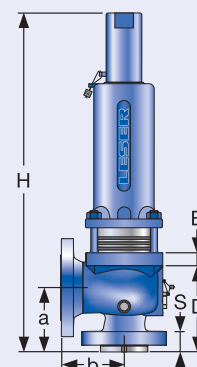

Balanced bellows design



## Pressure temperature ratings

Metric Units						
Valve size		4 P 6	4 P 6	4 P 6	4 P 6	4 P 6
Flange rating class <small>Inlet x Outlet</small>		150 x 150	300L x 150	300 x 150	600 x 150	900 x 150
Actual Orifice diameter $d_0$ [mm]		80.0	80.0	80.0	80.0	80.0
Actual Orifice area $A_0$ [mm <sup>2</sup> ]		5027	5027	5027	5027	5027
Minimum set pressure [bar] S/G/L		0.12	0.12	0.25	0.25	0.25
Minimum set pressure [bar] S/G		2.3	2.3	2.3	2.3	2.3
Balanced bellows Inconel [bar] L		2.5	2.5	2.5	2.5	2.5
<b>Body material: WCB 1.0619</b>		<b>Pressure range p [bar] S/G/L</b>				
<b>Maximum set pressure</b>	-29 to 38 °C	19.7	19.7	36.2	69.0	-
	39 to 232 °C	12.8	19.7	36.2	69.0	-
	233 to 427 °C	5.5	19.7	28.3	56.9	69.0
<b>Outlet pressure limit</b> Conventional design		19.7	19.7	19.7	19.7	19.7
<b>Outlet pressure limit</b> Balanced bellows design		5.5	5.5	10.3	10.3	10.3
<b>Body material: CF8M 1.4408</b>		<b>Pressure range p [bar] S/G/L</b>				
<b>Maximum set pressure</b>	-268 to -60 °C	12.1	12.1	20.7	33.1	-
	-59 to -29 °C	19.0	19.0	36.2	69.0	-
	-28 to 38 °C	19.0	19.0	36.2	69.0	-
	39 to 232 °C	12.4	12.4	34.1	67.2	-
	233 to 427 °C	5.5	5.5	29.0	58.3	-
	428 to 538 °C	1.4	1.4	24.1	48.3	-
<b>Outlet pressure limit</b> Conventional design		19.0	19.0	19.0	19.0	-
<b>Outlet pressure limit</b> Balanced bellows design		5.5	5.5	10.3	10.3	-
<b>Body material: WC6 1.7357</b>		<b>Pressure range p [bar] S/G/L</b>				
<b>Maximum set pressure</b>	233 to 427 °C	-	-	35.2	69.0	69.0
	428 to 538 °C	-	-	14.8	29.7	44.8
<b>Outlet pressure limit</b> Conventional design		-	-	19.7	19.7	19.7
<b>Outlet pressure limit</b> Balanced bellows design		-	-	10.3	10.3	10.3
<b>Body material: LCB</b>		<b>Pressure range p [bar] S/G/L</b>				
<b>Maximum set pressure</b>	-46 to 38 °C	18.4	18.4	48.0	96.0	144.1
	39 to 200 °C	13.8	13.8	42.5	85.1	127.6
	201 to 343 °C	8.4	8.4	36.4	72.8	109.2
<b>Outlet pressure limit</b> Conventional design		18.4	18.4	18.4	18.4	18.4
<b>Outlet pressure limit</b> Balanced bellows design		5.5	5.5	10.3	10.3	10.3

Remark: SA 352 Gr. LCB is not listed in the API 526. Pressure-Temperature Rating acc. to ASME B16.34 Table 2-1.3  
The stated Pressure-Temperature Rating are taken from ASME B16.34 Table 2-1.3 if the maximum pressure is not limited by API 526.

Due to the extended material test certificate the LESER LCB can be applied as LCC, WCB, WCC and 1.0619 with the respective pressure-temperature range as well.

## Pressure temperature ratings

US Units						
Valve size		4 P 6	4 P 6	4 P 6	4 P 6	4 P 6
Flange rating class <small>Inlet x Outlet</small>		150 x 150	300L x 150	300 x 150	600 x 150	900 x 150
Actual Orifice diameter $d_0$ [inch]		3.15	3.15	3.15	3.15	3.15
Actual Orifice area $A_0$ [inch <sup>2</sup> ]		7.79	7.79	7.79	7.79	7.79
Minimum set pressure [psig] S/G/L		2.0	2.0	4.0	4.0	4.0
Minimum set pressure [psig] S/G		33.4	33.4	33.4	33.4	33.4
Balanced bellows Inconel [psig] L		36.3	36.3	36.3	36.3	36.3
<b>Body material: WCB 1.0619</b>		<b>Pressure range p [psig] S/G/L</b>				
<b>Maximum set pressure</b>	-20 to 100 °F	285	285	525	1000	-
	101 to 450 °F	185	285	525	1000	-
	451 to 800 °F	80	285	410	825	1000
<b>Outlet pressure limit</b> Conventional design		285	285	285	285	285
<b>Outlet pressure limit</b> Balanced bellows design		80	80	150	150	150
<b>Body material: CF8M 1.4408</b>		<b>Pressure range p [psig] S/G/L</b>				
<b>Maximum set pressure</b>	-450 to -76 °F	175	175	300	480	-
	-75 to -21 °F	275	275	525	1000	-
	-20 to 100 °F	275	275	525	1000	-
	101 to 450 °F	180	180	495	975	-
	451 to 800 °F	80	80	420	845	-
	801 to 1000 °F	20	20	350	700	-
<b>Outlet pressure limit</b> Conventional design		275	275	275	275	-
<b>Outlet pressure limit</b> Balanced bellows design		80	80	150	150	-
<b>Body material: WC6 1.7357</b>		<b>Pressure range p [psig] S/G/L</b>				
<b>Maximum set pressure</b>	451 to 800 °F	-	-	510	1000	1000
	801 to 1000 °F	-	-	215	430	650
<b>Outlet pressure limit</b> Conventional design		-	-	285	285	285
<b>Outlet pressure limit</b> Balanced bellows design		-	-	150	150	150
<b>Body material: LCB</b>		<b>Pressure range p [psig] S/G/L</b>				
<b>Maximum set pressure</b>	-50 to 100 °F	265	265	695	1395	2090
	101 to 400 °F	200	200	615	1230	1845
	401 to 650 °F	125	125	535	1065	1600
<b>Outlet pressure limit</b> Conventional design		265	265	265	265	265
<b>Outlet pressure limit</b> Balanced bellows design		80	80	150	150	150

Remark: SA 352 Gr. LCB is not listed in the API 526. Pressure-Temperature Rating acc. to ASME B16.34 Table 2-1.3  
The stated Pressure-Temperature Rating are taken from ASME B16.34 Table 2-1.3 if the maximum pressure is not limited by API 526.

Due to the extended material test certificate the LESER LCB can be applied as LCC, WCB, WCC and 1.0619 with the respective pressure-temperature range as well.



## Selection chart

	150 x 150	300L x 150	300 x 150	600 x 150	900 x 150	1500 x 150	2500 x 300
WC6	5262.657X	See 300 x 150	5262.658X	5262.659X	-	-	-
WC6	-	See 300 x 150	5267.660X	5267.661X	-	-	-

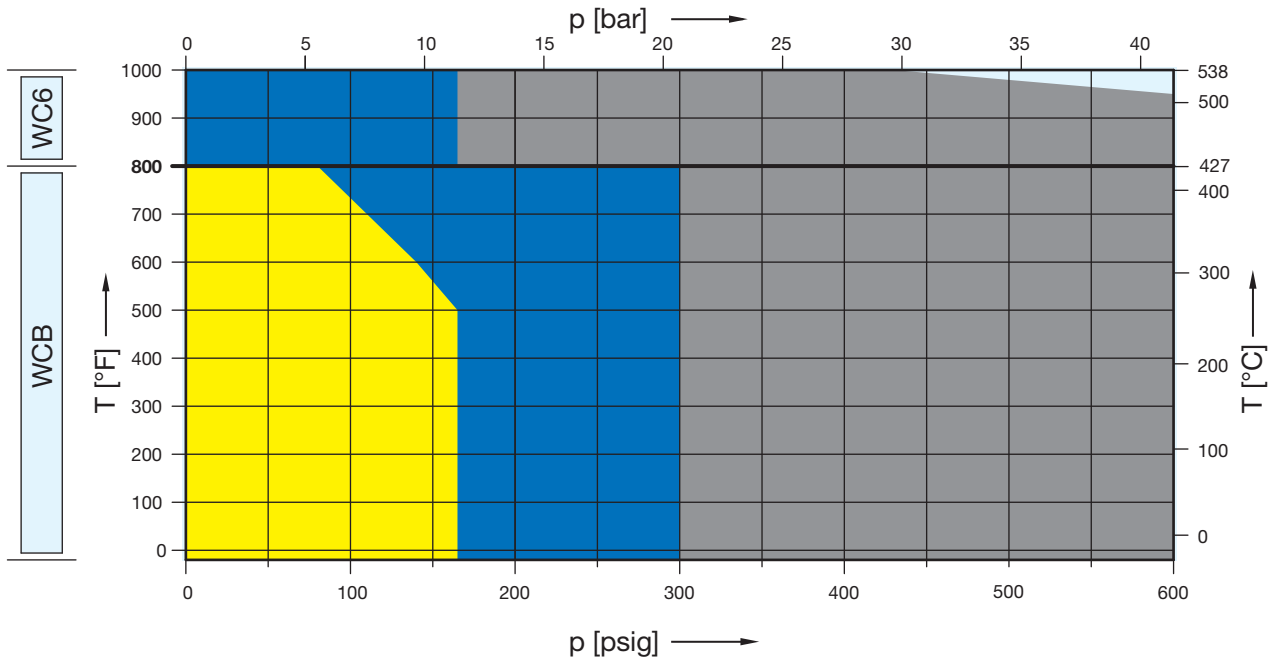

	150 x 150	300L x 150	300 x 150	600 x 150	900 x 150	1500 x 150	2500 x 300
CF8M	5264.662X	See 300 x 150	5264.663X	5264.664X	-	-	-

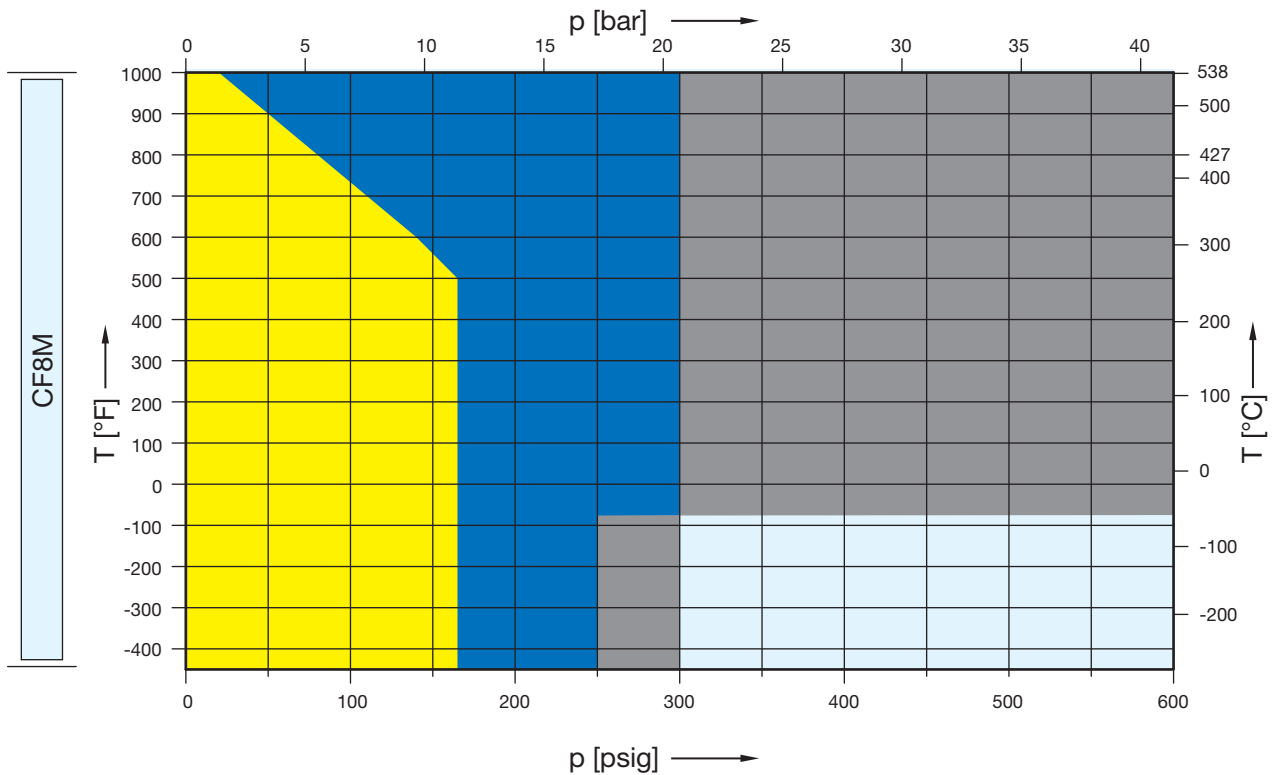

## Article numbers, dimensions and weights

### Article numbers

Valve size	6 Q 8	6 Q 8	6 Q 8	6 Q 8
Flange rating class Inlet x Outlet	150 x 150	300L x 150	300 x 150	600 x 150
Actual Orifice diameter $d_0$ [mm]	105.5	105.5	105.5	105.5
Actual Orifice area $A_0$ [mm <sup>2</sup> ]	8742	8742	8742	8742

### Body material

WCB 1.0619	Art.-No.	5262.657 <sup>□</sup>	Use 6 Q 8 300 x 150	5262.658 <sup>□</sup>	5262.659 <sup>□</sup>
CF8M 1.4408	Art.-No.	5264.662 <sup>□</sup>		5264.663 <sup>□</sup>	5264.664 <sup>□</sup>
WC6 1.7357	Art.-No.	-		5267.660 <sup>□</sup>	5267.661 <sup>□</sup>
LCB	Art.-No.	5263.559 <sup>□</sup>		5263.560 <sup>□</sup>	5263.561 <sup>□</sup>

<sup>□</sup> Please add code for the required cap or lifting device. See below.

### Dimensions and weights

#### Metric Units

<b>Weight</b> [kg]		221	Use 6 Q 8 300 x 150	221	221
	with bellows	230		230	230
<b>Center to face</b> [mm]	Inlet a	240		240	240
	Outlet b	241		241	241
	s	68		68	68
<b>Height (H4)</b> [mm]	Standard H max.	1120		1120	1120
	Bellows H max.	1200		1200	1200
<b>Support brackets</b> [mm]	A	370		370	370
	B	210		210	210
	C	Ø 18		Ø 18	Ø 18
	D	346	346	346	
	E	25	25	25	

#### US Units

<b>Weight</b> [lbs]		487,3	Use 6 Q 8 300 x 150	487,3	487,3
	with bellows	507,2		507,2	507,2
<b>Center to face</b> [inch]	Inlet a	9 <sup>7</sup> / <sub>16</sub>		9 <sup>7</sup> / <sub>16</sub>	9 <sup>7</sup> / <sub>16</sub>
	Outlet b	9 <sup>1</sup> / <sub>2</sub>		9 <sup>1</sup> / <sub>2</sub>	9 <sup>1</sup> / <sub>2</sub>
	s	2 <sup>11</sup> / <sub>16</sub>		2 <sup>11</sup> / <sub>16</sub>	2 <sup>11</sup> / <sub>16</sub>
<b>Height (H4)</b> [inch]	Standard H max.	44 <sup>1</sup> / <sub>8</sub>		44 <sup>1</sup> / <sub>8</sub>	44 <sup>1</sup> / <sub>8</sub>
	Bellows H max.	47 <sup>1</sup> / <sub>4</sub>		47 <sup>1</sup> / <sub>4</sub>	47 <sup>1</sup> / <sub>4</sub>
<b>Support brackets</b> [inch]	A	14 <sup>9</sup> / <sub>16</sub>		14 <sup>9</sup> / <sub>16</sub>	14 <sup>9</sup> / <sub>16</sub>
	B	8 <sup>9</sup> / <sub>32</sub>		8 <sup>9</sup> / <sub>32</sub>	8 <sup>9</sup> / <sub>32</sub>
	C	Ø <sup>23</sup> / <sub>32</sub>		Ø <sup>23</sup> / <sub>32</sub>	Ø <sup>23</sup> / <sub>32</sub>
	D	13 <sup>5</sup> / <sub>8</sub>	13 <sup>5</sup> / <sub>8</sub>	13 <sup>5</sup> / <sub>8</sub>	
	E	<sup>31</sup> / <sub>32</sub>	<sup>31</sup> / <sub>32</sub>	<sup>31</sup> / <sub>32</sub>	

### Code for lifting device

Lifting device	H2	H3	H4	H3
Bonnet	closed	closed	closed	open
WCB 1.0619, WC6 1.7357, LCB	2	3	4	5
CF8M 1.4408	2	-	4	-

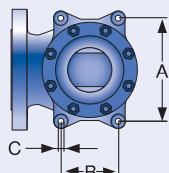

Support brackets

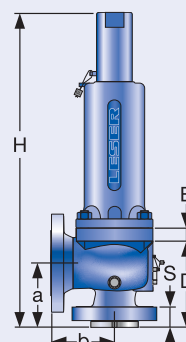

Conventional design

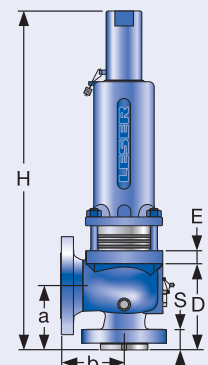

Balanced bellows design

## Pressure temperature ratings

Metric Units					
Valve size		6 Q 8	6 Q 8	6 Q 8	6 Q 8
Flange rating class <small>Inlet x Outlet</small>		150 x 150	300L x 150	300 x 150	600 x 150
Actual Orifice diameter $d_0$ [mm]		105.5	105.5	105.5	105.5
Actual Orifice area $A_0$ [mm <sup>2</sup> ]		8742	8742	8742	8742
Minimum set pressure [bar] S/G/L		0.2	0.2	0.2	0.2
Minimum set pressure [bar] S/G		1.3	1.3	1.3	1.3
Balanced bellows Inconel [bar] L		2.3	2.3	2.3	2.3
<b>Body material: WCB 1.0619</b>		<b>Pressure range p [bar] S/G/L</b>			
<b>Maximum set pressure</b>	-29 to 38 °C	11.4	Use 6 Q 8 300 x 150	20.7	41.4
	39 to 232 °C	11.4		20.7	41.4
	233 to 427 °C	5.5		20.7	41.4
<b>Outlet pressure limit</b> Conventional design	7.9	7.9		7.9	
<b>Outlet pressure limit</b> Balanced bellows design	4.8	7.9		7.9	
<b>Body material: CF8M 1.4408</b>		<b>Pressure range p [bar] S/G/L</b>			
<b>Maximum set pressure</b>	-268 to -60 °C	11.4	Use 6 Q 8 300 x 150	17.2	20.7
	-59 to -29 °C	11.4		20.7	41.4
	-28 to 38 °C	11.4		20.7	41.4
	39 to 232 °C	11.4		20.7	41.4
	233 to 427 °C	5.5		20.7	41.4
	428 to 538 °C	1.4		20.7	41.4
<b>Outlet pressure limit</b> Conventional design	7.9	7.9	7.9		
<b>Outlet pressure limit</b> Balanced bellows design	4.8	7.9	7.9		
<b>Body material: WC6 1.7357</b>		<b>Pressure range p [bar] S/G/L</b>			
<b>Maximum set pressure</b>	233 to 427 °C	-	Use 6 Q 8 300 x 150	11.4	41.4
	428 to 538 °C	-		11.4	29.7
<b>Outlet pressure limit</b> Conventional design	-	7.9		7.9	
<b>Outlet pressure limit</b> Balanced bellows design	-	7.9		7.9	
<b>Body material: LCB</b>		<b>Pressure range p [bar] S/G/L</b>			
<b>Maximum set pressure</b>	-46 to 38 °C	18.4	Use 6 Q 8 300 x 150	48.0	96.0
	39 to 200 °C	13.8		42.5	85.1
	201 to 343 °C	8.4		36.4	72.8
<b>Outlet pressure limit</b> Conventional design	7.9	7.9		7.9	
<b>Outlet pressure limit</b> Balanced bellows design	4.8	7.9		7.9	

Remark: SA 352 Gr. LCB is not listed in the API 526. Pressure-Temperature Rating acc. to ASME B16.34 Table 2-1.3  
The stated Pressure-Temperature Rating are taken from ASME B16.34 Table 2-1.3 if the maximum pressure is not limited by API 526.

Due to the extended material test certificate the LESER LCB can be applied as LCC, WCB, WCC and 1.0619 with the respective pressure-temperature range as well.

## Pressure temperature ratings

US Units					
Valve size		6 Q 8	6 Q 8	6 Q 8	6 Q 8
Flange rating class <small>Inlet x Outlet</small>		150 x 150	300L x 150	300 x 150	600 x 150
Actual Orifice diameter $d_0$ [inch]		4.15	4.15	4.15	4.15
Actual Orifice area $A_0$ [inch <sup>2</sup> ]		13.55	13.55	13.55	13.55
Minimum set pressure [psig] S/G/L		3.0	3.0	3.0	3.0
Minimum set pressure [psig] S/G		18.8	18.8	18.8	18.8
Balanced bellows Inconel [psig] L		33.4	33.4	33.4	33.4
<b>Body material: WCB 1.0619</b>		<b>Pressure range p [psig] S/G/L</b>			
<b>Maximum set pressure</b>	-20 to 100 °F	165	Use 6 Q 8 300 x 150	300	600
	101 to 450 °F	165		300	600
	451 to 800 °F	80		300	600
<b>Outlet pressure limit</b> Conventional design		115		115	115
<b>Outlet pressure limit</b> Balanced bellows design		70		115	115
<b>Body material: CF8M 1.4408</b>		<b>Pressure range p [psig] S/G/L</b>			
<b>Maximum set pressure</b>	-450 to -76 °F	165	Use 6 Q 8 300 x 150	250	300
	-75 to -21 °F	165		300	600
	-20 to 100 °F	165		300	600
	101 to 450 °F	165		300	600
	451 to 800 °F	80		300	600
	801 to 1000 °F	20		300	600
<b>Outlet pressure limit</b> Conventional design		115	115	115	
<b>Outlet pressure limit</b> Balanced bellows design		70	115	115	
<b>Body material: WC6 1.7357</b>		<b>Pressure range p [psig] S/G/L</b>			
<b>Maximum set pressure</b>	451 to 800 °F	–	Use 6 Q 8 300 x 150	165	600
	801 to 1000 °F	–		165	430
<b>Outlet pressure limit</b> Conventional design		–		115	115
<b>Outlet pressure limit</b> Balanced bellows design		–		115	115
<b>Body material: LCB</b>		<b>Pressure range p [psig] S/G/L</b>			
<b>Maximum set pressure</b>	-50 to 100 °F	265	Use 6 Q 8 300 x 150	695	1395
	101 to 400 °F	200		615	1230
	401 to 650 °F	125		535	1065
<b>Outlet pressure limit</b> Conventional design		115		115	115
<b>Outlet pressure limit</b> Balanced bellows design		70		115	115

Remark: SA 352 Gr. LCB is not listed in the API 526. Pressure-Temperature Rating acc. to ASME B16.34 Table 2-1.3  
The stated Pressure-Temperature Rating are taken from ASME B16.34 Table 2-1.3 if the maximum pressure is not limited by API 526.

Due to the extended material test certificate the LESER LCB can be applied as LCC, WCB, WCC and 1.0619 with the respective pressure-temperature range as well.

## Selection chart

	150 x 150	300L x 150	300 x 150	600 x 150	900 x 150	1500 x 150	2500 x 300
WCB	5262.665X	5262.666X	5262.667X	5262.668X	-	-	-
WC6	-	5267.669X	-	5267.670X	-	-	-

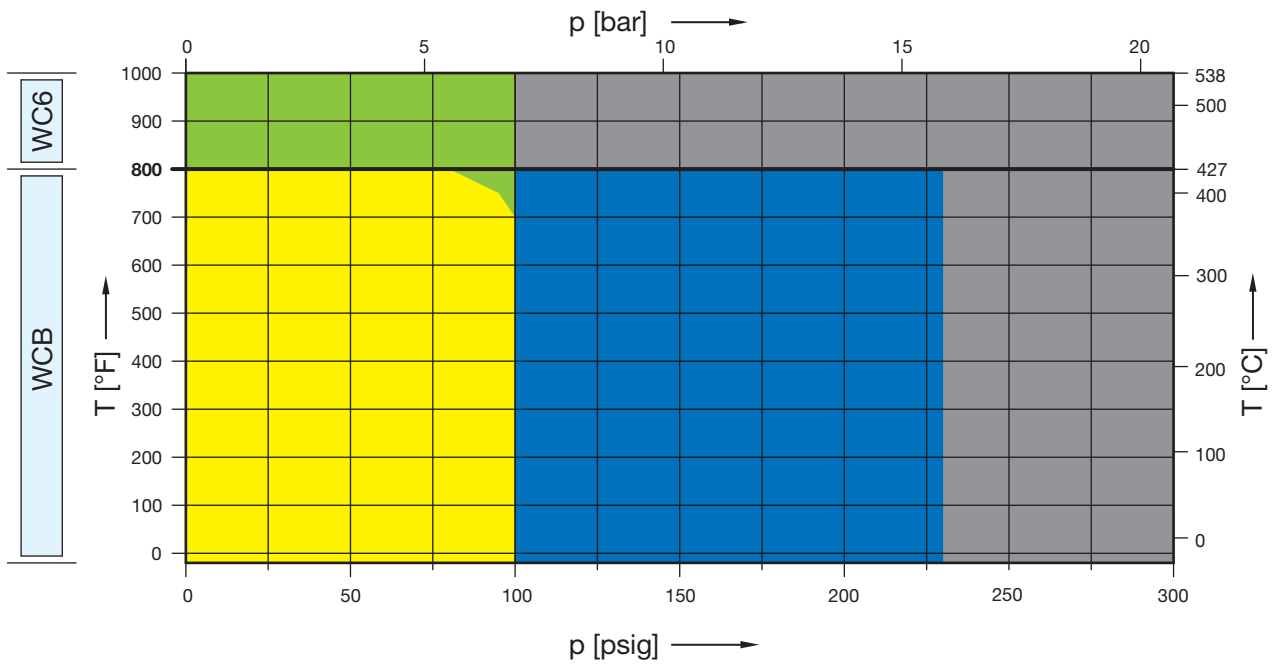

	150 x 150	300L x 150	300 x 150	600 x 150	900 x 150	1500 x 150	2500 x 300
CF8M	5264.671X	5264.672X	5264.673X	5264.674X	-	-	-

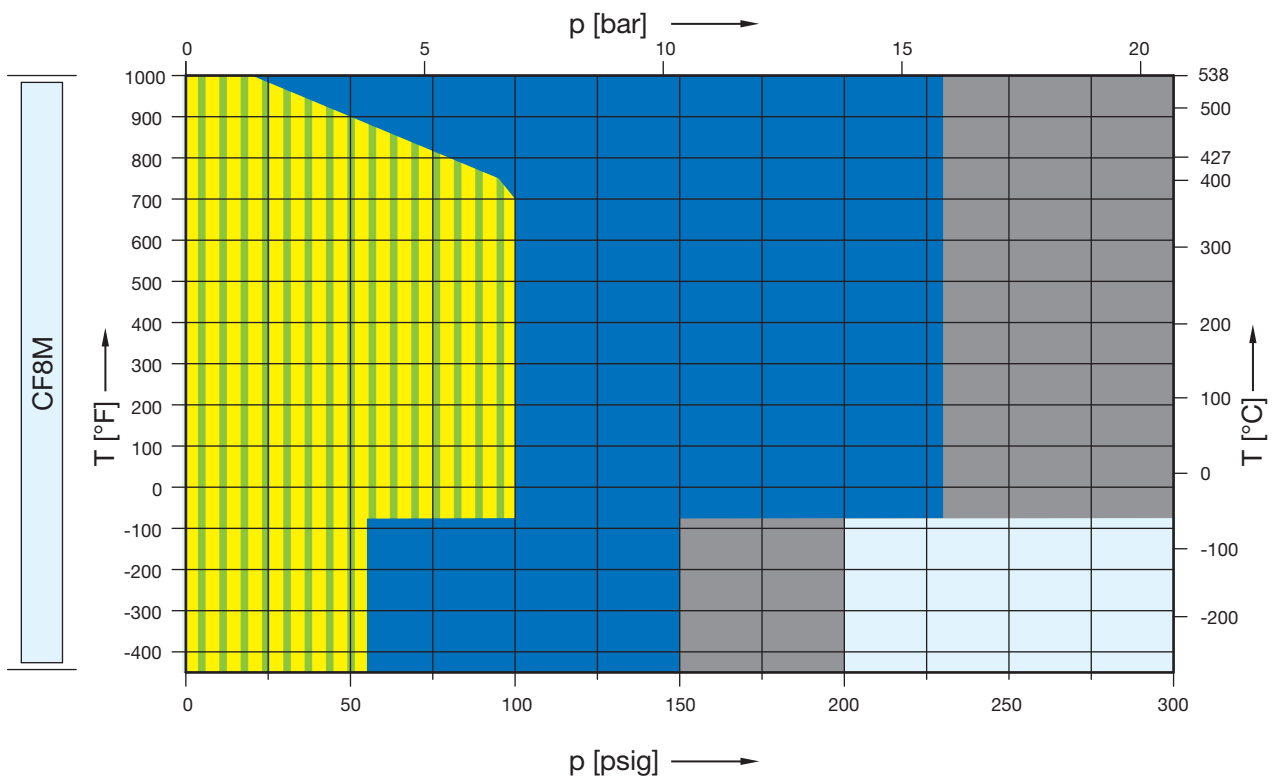

R



## Article numbers, dimensions and weights

### Article numbers

Valve size	6 R 8	6 R 8	6 R 10	6 R 10
Flange rating class Inlet x Outlet	150 x 150	300L x 150	300 x 150	600 x 150
Actual Orifice diameter $d_0$ [mm]	126.0	126.0	126.0	126.0
Actual Orifice area $A_0$ [mm <sup>2</sup> ]	12568	12568	12568	12568

### Body material

WCB 1.0619	Art.-No.	5262.665 <sup>□</sup>	5262.666 <sup>□</sup>	5262.667 <sup>□</sup>	5262.668 <sup>□</sup>
CF8M 1.4408	Art.-No.	5264.671 <sup>□</sup>	5264.672 <sup>□</sup>	5264.673 <sup>□</sup>	5264.674 <sup>□</sup>
WC6 1.7357	Art.-No.	-	5267.669 <sup>□</sup>	-	5267.670 <sup>□</sup>
LCB	Art.-No.	5263.562 <sup>□</sup>	5263.563 <sup>□</sup>	5263.564 <sup>□</sup>	5263.565 <sup>□</sup>

<sup>□</sup> Please add code for the required cap or lifting device. See below.

### Dimensions and weights

#### Metric Units

<b>Weight</b> [kg]		221	221	277	277
	with bellows	230	230	288	288
<b>Center to face</b> [mm]	Inlet a	240	240	240	240
	Outlet b	241	241	267	267
	s	68	68	70	70
<b>Height (H4)</b> [mm]	Standard H max.	1120	1120	1426	1426
	Bellows H max.	1200	1200	1426	1426
<b>Support brackets</b> [mm]	A	370	370	470	470
	B	210	210	150	150
	C	Ø 18	Ø 18	Ø 18	Ø 18
	D	346	346	460	460
	E	25	25	25	25

#### US Units

<b>Weight</b> [lbs]		487.3	487.3	610.8	610.8
	with bellows	507.2	507.2	635	635
<b>Center to face</b> [inch]	Inlet a	9 <sup>7</sup> / <sub>16</sub>	9 <sup>7</sup> / <sub>16</sub>	9 <sup>7</sup> / <sub>16</sub>	9 <sup>7</sup> / <sub>16</sub>
	Outlet b	9 <sup>1</sup> / <sub>2</sub>	9 <sup>1</sup> / <sub>2</sub>	10 <sup>1</sup> / <sub>2</sub>	10 <sup>1</sup> / <sub>2</sub>
	s	2 <sup>11</sup> / <sub>16</sub>	2 <sup>11</sup> / <sub>16</sub>	2 <sup>3</sup> / <sub>4</sub>	2 <sup>3</sup> / <sub>4</sub>
<b>Height (H4)</b> [inch]	Standard H max.	44 <sup>1</sup> / <sub>8</sub>	44 <sup>1</sup> / <sub>8</sub>	56 <sup>1</sup> / <sub>8</sub>	56 <sup>1</sup> / <sub>8</sub>
	Bellows H max.	47 <sup>1</sup> / <sub>4</sub>	47 <sup>1</sup> / <sub>4</sub>	56 <sup>1</sup> / <sub>8</sub>	56 <sup>1</sup> / <sub>8</sub>
<b>Support brackets</b> [inch]	A	14 <sup>9</sup> / <sub>16</sub>	14 <sup>9</sup> / <sub>16</sub>	5 <sup>1</sup> / <sub>8</sub>	5 <sup>1</sup> / <sub>8</sub>
	B	8 <sup>9</sup> / <sub>32</sub>	8 <sup>9</sup> / <sub>32</sub>	5 <sup>29</sup> / <sub>32</sub>	5 <sup>29</sup> / <sub>32</sub>
	C	Ø <sup>23</sup> / <sub>32</sub>	Ø <sup>23</sup> / <sub>32</sub>	Ø <sup>23</sup> / <sub>32</sub>	Ø <sup>23</sup> / <sub>32</sub>
	D	13 <sup>5</sup> / <sub>8</sub>	13 <sup>5</sup> / <sub>8</sub>	18 <sup>1</sup> / <sub>8</sub>	18 <sup>1</sup> / <sub>8</sub>
	E	<sup>31</sup> / <sub>32</sub>	<sup>31</sup> / <sub>32</sub>	<sup>31</sup> / <sub>32</sub>	<sup>31</sup> / <sub>32</sub>

### □ Code for lifting device

Lifting device	H2	H3	H4	H3
Bonnet	closed	closed	closed	open
WCB 1.0619, WC6 1.7357, LCB	2	3	4	5
CF8M 1.4408	2	-	4	-

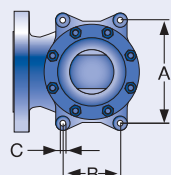

Support brackets

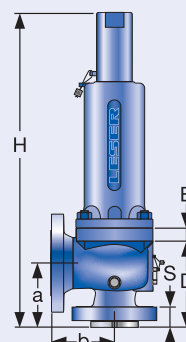

Conventional design

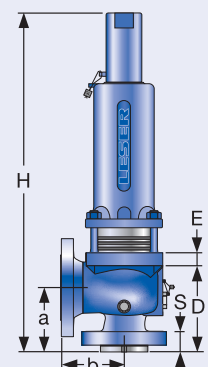

Balanced bellows design

## Pressure temperature ratings

Metric Units					
Valve size		6 R 8	6 R 8	6 R 10	6 R 10
Flange rating class <small>Inlet x Outlet</small>		150 x 150	300L x 150	300 x 150	600 x 150
Actual Orifice diameter $d_0$ [mm]		126.0	126.0	126.0	126.0
Actual Orifice area $A_0$ [mm <sup>2</sup> ]		12568	12568	12568	12568
Minimum set pressure [bar] S/G/L		0.2	0.2	0.2	0.2
Minimum set pressure [bar] S/G		1.0	1.0	3.0	3.0
Balanced bellows Inconel [bar] L		1.4	1.4	3.0	3.0
<b>Body material: WCB 1.0619</b>		<b>Pressure range p [bar] S/G/L</b>			
<b>Maximum set pressure</b>	-29 to 38 °C	6.9	6.9	15.9	20.7
	39 to 232 °C	6.9	6.9	15.9	20.7
	233 to 427 °C	5.5	6.9	15.9	20.7
<b>Outlet pressure limit</b> Conventional design		4.1	4.1	6.9	6.9
<b>Outlet pressure limit</b> Balanced bellows design		4.1	4.1	6.9	6.9
<b>Body material: CF8M 1.4408</b>		<b>Pressure range p [bar] S/G/L</b>			
<b>Maximum set pressure</b>	-268 to -60 °C	3.8	3.8	10.3	13.8
	-59 to -29 °C	6.9	6.9	15.9	20.7
	-28 to 38 °C	6.9	6.9	15.9	20.7
	39 to 232 °C	6.9	6.9	15.9	20.7
	233 to 427 °C	5.5	5.5	15.9	20.7
	428 to 538 °C	1.4	1.4	15.9	20.7
<b>Outlet pressure limit</b> Conventional design		4.1	4.1	6.9	6.9
<b>Outlet pressure limit</b> Balanced bellows design		4.1	4.1	6.9	6.9
<b>Body material: WC6 1.7357</b>		<b>Pressure range p [bar] S/G/L</b>			
<b>Maximum set pressure</b>	233 to 427 °C	-	-	6.9	20.7
	428 to 538 °C	-	-	6.9	20.7
<b>Outlet pressure limit</b> Conventional design		-	-	4.1	6.9
<b>Outlet pressure limit</b> Balanced bellows design		-	-	4.1	6.9
<b>Body material: LCB</b>		<b>Pressure range p [bar] S/G/L</b>			
<b>Maximum set pressure</b>	-46 to 38 °C	18.4	18.4	48.0	96.0
	39 to 200 °C	13.8	13.8	42.5	85.1
	201 to 343 °C	8.4	8.4	36.4	72.8
<b>Outlet pressure limit</b> Conventional design		4.1	4.1	6.9	6.9
<b>Outlet pressure limit</b> Balanced bellows design		4.1	4.1	6.9	6.9

Remark: SA 352 Gr. LCB is not listed in the API 526. Pressure-Temperature Rating acc. to ASME B16.34 Table 2-1.3  
The stated Pressure-Temperature Rating are taken from ASME B16.34 Table 2-1.3 if the maximum pressure is not limited by API 526.

Due to the extended material test certificate the LESER LCB can be applied as LCC, WCB, WCC and 1.0619 with the respective pressure-temperature range as well.

## Pressure temperature ratings

US Units					
Valve size		6 R 8	6 R 8	6 R 10	6 R 10
Flange rating class <small>Inlet x Outlet</small>		150 x 150	300L x 150	300 x 150	600 x 150
Actual Orifice diameter $d_0$ [inch]		4.96	4.96	4.96	4.96
Actual Orifice area $A_0$ [inch <sup>2</sup> ]		19.48	19.48	19.48	19.48
Minimum set pressure [psig] S/G/L		3.0	3.0	3.0	3.0
Minimum set pressure [psig] S/G		14.5	14.5	43.5	43.5
Balanced bellows Inconel [psig] L		20.3	20.3	43.5	43.5
<b>Body material: WCB 1.0619</b>		<b>Pressure range p [psig] S/G/L</b>			
<b>Maximum set pressure</b>	-20 to 100 °F	100	100	230	300
	101 to 450 °F	100	100	230	300
	451 to 800 °F	80	100	230	300
<b>Outlet pressure limit</b> Conventional design		60	60	100	100
<b>Outlet pressure limit</b> Balanced bellows design		60	60	100	100
<b>Body material: CF8M 1.4408</b>		<b>Pressure range p [psig] S/G/L</b>			
<b>Maximum set pressure</b>	-450 to -76 °F	55	55	150	200
	-75 to -21 °F	100	100	230	300
	-20 to 100 °F	100	100	230	300
	101 to 450 °F	100	100	230	300
	451 to 800 °F	80	80	230	300
	801 to 1000 °F	20	20	230	300
<b>Outlet pressure limit</b> Conventional design		60	60	100	100
<b>Outlet pressure limit</b> Balanced bellows design		60	60	100	100
<b>Body material: WC6 1.7357</b>		<b>Pressure range p [psig] S/G/L</b>			
<b>Maximum set pressure</b>	451 to 800 °F	-	-	100	300
	801 to 1000 °F	-	-	100	300
<b>Outlet pressure limit</b> Conventional design		-	-	60	100
<b>Outlet pressure limit</b> Balanced bellows design		-	-	60	100
<b>Body material: LCB</b>		<b>Pressure range p [psig] S/G/L</b>			
<b>Maximum set pressure</b>	-50 to 100 °F	265	265	695	1395
	101 to 400 °F	200	200	615	1230
	401 to 650 °F	125	125	535	1065
<b>Outlet pressure limit</b> Conventional design		60	60	100	100
<b>Outlet pressure limit</b> Balanced bellows design		60	60	100	100

Remark: SA 352 Gr. LCB is not listed in the API 526. Pressure-Temperature Rating acc. to ASME B16.34 Table 2-1.3  
The stated Pressure-Temperature Rating are taken from ASME B16.34 Table 2-1.3 if the maximum pressure is not limited by API 526.

Due to the extended material test certificate the LESER LCB can be applied as LCC, WCB, WCC and 1.0619 with the respective pressure-temperature range as well.

## Selection chart

	150 x 150	300L x 150	300 x 150	600 x 150	900 x 150	1500 x 150	2500 x 300
WC6	5262.675X	See 300 x 150	5262.676X	-	-	-	-
WC6	-	See 300 x 150	5267.677X	-	-	-	-

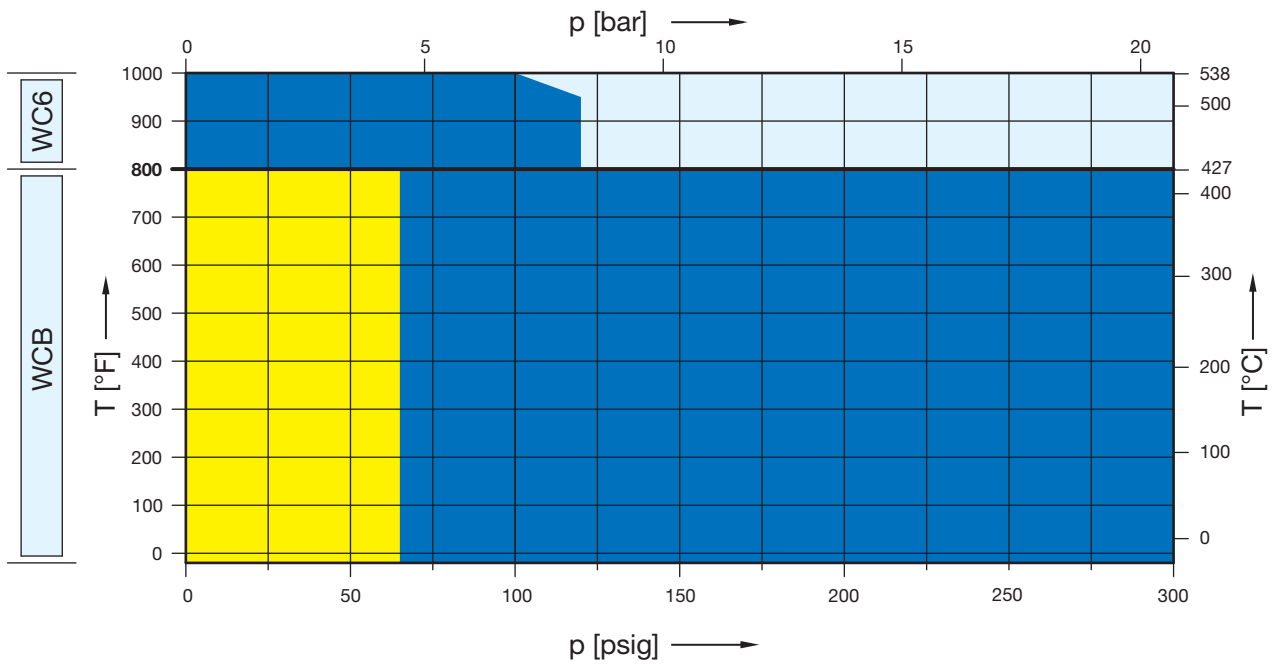

	150 x 150	300L x 150	300 x 150	600 x 150	900 x 150	1500 x 150	2500 x 300
CF8M	5264.678X	See 300 x 150	5264.679X	-	-	-	-

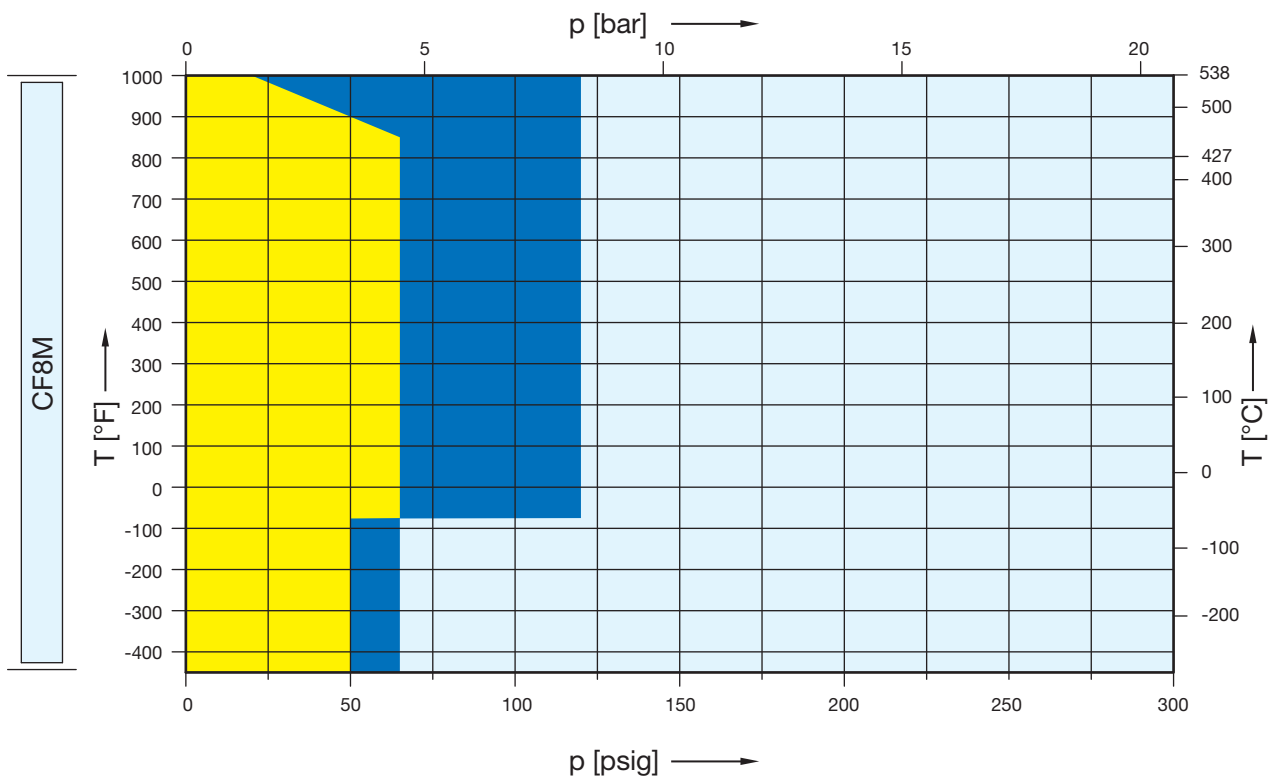

## Article numbers, dimensions and weights

### Article numbers

Valve size	8 T 10	8 T 10	8 T 10
Flange rating class <small>Inlet x Outlet</small>	150 x 150	300L x 150	300 x 150
Actual Orifice diameter $d_0$ [mm]	161,5	161,5	161,5
Actual Orifice area $A_0$ [mm <sup>2</sup> ]	20485	20485	20485
<b>Body material</b>			
WCB 1.0619	Art.-No. <b>5262.675<sup>□</sup></b>	Use 8 T 10 300 x 150	<b>5262.676<sup>□</sup></b>
CF8M 1.4408	Art.-No. <b>5264.678<sup>□</sup></b>		<b>5264.679<sup>□</sup></b>
WC6 1.7357	Art.-No. -		<b>5267.677<sup>□</sup></b>
LCB	Art.-No. <b>5263.566<sup>□</sup></b>		<b>5263.567<sup>□</sup></b>

<sup>□</sup> Please add code for the required cap or lifting device. See below.

### Dimensions and weights

#### Metric Units

<b>Weight</b> [kg]		287	287
	with bellows	298	298
<b>Center to face</b> [mm]	Inlet a	276	276
	Outlet b	279	279
	s	62	62
<b>Height (H4)</b> [mm]	Standard H max.	1462	1462
	Bellows H max.	1462	1462
<b>Support brackets</b> [mm]	A	470	470
	B	-	-
	C	Ø 18	Ø 18
	D	497	497
	E	25	25

#### US Units

<b>Weight</b> [lbs]		632.8	632.8
	with bellows	657.1	657.1
<b>Center to face</b> [inch]	Inlet a	10 <sup>7</sup> / <sub>8</sub>	10 <sup>7</sup> / <sub>8</sub>
	Outlet b	11	11
	s	2 <sup>7</sup> / <sub>16</sub>	2 <sup>7</sup> / <sub>16</sub>
<b>Height (H4)</b> [inch]	Standard H max.	57 <sup>9</sup> / <sub>16</sub>	57 <sup>9</sup> / <sub>16</sub>
	Bellows H max.	57 <sup>9</sup> / <sub>16</sub>	57 <sup>9</sup> / <sub>16</sub>
<b>Support brackets</b> [inch]	A	18 <sup>1</sup> / <sub>2</sub>	18 <sup>1</sup> / <sub>2</sub>
	B	-	-
	C	Ø <sup>23</sup> / <sub>32</sub>	Ø <sup>23</sup> / <sub>32</sub>
	D	19 <sup>9</sup> / <sub>16</sub>	19 <sup>9</sup> / <sub>16</sub>
	E	<sup>31</sup> / <sub>32</sub>	<sup>31</sup> / <sub>32</sub>

#### □ Code for lifting device

Lifting device	<b>H2</b>	<b>H3</b>	<b>H4</b>	<b>H3</b>
Bonnet	closed	closed	closed	open
WCB 1.0619, WC6 1.7357, LCB	2	3	4	5
CF8M 1.4408	2	-	4	-

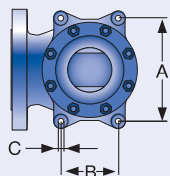

Support brackets

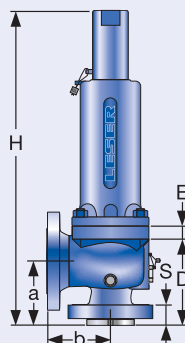

Conventional design

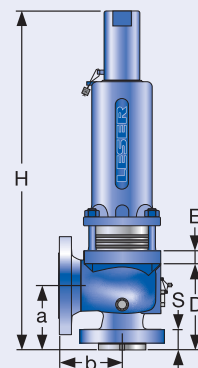

Balanced bellows design

## Pressure temperature ratings

Metric Units				
Valve size		8 T 10	8 T 10	8 T 10
Flange rating class <small>Inlet x Outlet</small>		150 x 150	300L x 150	300 x 150
Actual Orifice diameter $d_0$ [mm]		161.5	161.5	161.5
Actual Orifice area $A_0$ [mm <sup>2</sup> ]		20485	20485	20485
Minimum set pressure [bar] S/G/L		0.25	0.25	0.25
Minimum set pressure [bar] S/G		1.2	1.2	1.2
Balanced bellows Inconel [bar] L		2.5	2.5	2.5
<b>Body material: WCB 1.0619</b>		<b>Pressure range p [bar] S/G/L</b>		
<b>Maximum set pressure</b>	-29 to 38 °C	4.5	Use 8 T 10 300 x 150	20.7
	39 to 232 °C	4.5		20.7
	233 to 427 °C	4.5		20.7
<b>Outlet pressure limit</b> Conventional design		2.1		6.9
<b>Outlet pressure limit</b> Balanced bellows design		2.1		6.9
<b>Body material: CF8M 1.4408</b>		<b>Pressure range p [bar] S/G/L</b>		
<b>Maximum set pressure</b>	-268 to -60 °C	3.4	Use 8 T 10 300 x 150	4.5
	-59 to -29 °C	4.5		8.3
	-28 to 38 °C	4.5		8.3
	39 to 232 °C	4.5		8.3
	233 to 427 °C	4.5		8.3
	428 to 538 °C	1.4		8.3
<b>Outlet pressure limit</b> Conventional design		2.1		4.1
<b>Outlet pressure limit</b> Balanced bellows design		2.1		4.1
<b>Body material: WC6 1.7357</b>		<b>Pressure range p [bar] S/G/L</b>		
<b>Maximum set pressure</b>	233 to 427 °C	–	Use 8 T 10 300 x 150	20.7
	428 to 538 °C	–		15.5
<b>Outlet pressure limit</b> Conventional design		–		6.9
<b>Outlet pressure limit</b> Balanced bellows design		–		6.9
<b>Body material: LCB</b>		<b>Pressure range p [bar] S/G/L</b>		
<b>Maximum set pressure</b>	-46 to 38 °C	18.4	Use 8 T 10 300 x 150	48.0
	39 to 200 °C	13.8		42.5
	201 to 343 °C	8.4		36.4
<b>Outlet pressure limit</b> Conventional design		2.1		6.9
<b>Outlet pressure limit</b> Balanced bellows design		2.1		6.9

Remark: SA 352 Gr. LCB is not listed in the API 526. Pressure-Temperature Rating acc. to ASME B16.34 Table 2-1.3  
The stated Pressure-Temperature Rating are taken from ASME B16.34 Table 2-1.3 if the maximum pressure is not limited by API 526.

Due to the extended material test certificate the LESER LCB can be applied as LCC, WCB, WCC and 1.0619 with the respective pressure-temperature range as well.

## Pressure temperature ratings

US Units				
Valve size		8 T 10	8 T 10	8 T 10
Flange rating class <small>Inlet x Outlet</small>		150 x 150	300L x 150	300 x 150
Actual Orifice diameter $d_0$ [inch]		6.36	6.36	6.36
Actual Orifice area $A_0$ [inch <sup>2</sup> ]		31.75	31.75	31.75
Minimum set pressure [psig] S/G/L		4.0	4.0	4.0
Minimum set pressure [psig] S/G		17.4	17.4	17.4
Minimum set pressure [psig] L		36.3	36.3	36.3
<b>Body material: WCB 1.0619</b>		<b>Pressure range p [psig] S/G/L</b>		
<b>Maximum set pressure</b>	-20 to 100 °F	65	Use 8 T 10 300 x 150	300
	101 to 450 °F	65		300
	451 to 800 °F	65		300
<b>Outlet pressure limit</b> Conventional design	30	100		
<b>Outlet pressure limit</b> Balanced bellows design	30	100		
<b>Body material: CF8M 1.4408</b>		<b>Pressure range p [psig] S/G/L</b>		
<b>Maximum set pressure</b>	-450 to -76 °F	50	Use 8 T 10 300 x 150	65
	-75 to -21 °F	65		120
	-20 to 100 °F	65		120
	101 to 450 °F	65		120
	451 to 800 °F	65		120
	801 to 1000 °F	20		120
<b>Outlet pressure limit</b> Conventional design	30	60		
<b>Outlet pressure limit</b> Balanced bellows design	30	60		
<b>Body material: WC6 1.7357</b>		<b>Pressure range p [psig] S/G/L</b>		
<b>Maximum set pressure</b>	451 to 800 °F	–	Use 8 T 10 300 x 150	300
	801 to 1000 °F	–		225
<b>Outlet pressure limit</b> Conventional design	–	100		
<b>Outlet pressure limit</b> Balanced bellows design	–	100		
<b>Body material: LCB</b>		<b>Pressure range p [psig] S/G/L</b>		
<b>Maximum set pressure</b>	-50 to 100 °F	265	Use 8 T 10 300 x 150	695
	101 to 400 °F	200		615
	401 to 650 °F	125		535
<b>Outlet pressure limit</b> Conventional design	30	100		
<b>Outlet pressure limit</b> Balanced bellows design	30	100		

Remark: SA 352 Gr. LCB is not listed in the API 526. Pressure-Temperature Rating acc. to ASME B16.34 Table 2-1.3  
The stated Pressure-Temperature Rating are taken from ASME B16.34 Table 2-1.3 if the maximum pressure is not limited by API 526.

Due to the extended material test certificate the LESER LCB can be applied as LCC, WCB, WCC and 1.0619 with the respective pressure-temperature range as well.



## Flange drillings

### Flange drillings

according to DIN EN 1092-1

Standard API 526		Article-No.					Flange drillings																		
Valve size	Flange class	Material				Inlet NPS [DN]	Inlet										Outlet NPS [DN]	Outlet							
		WCB 5262.	LCB 5263.	WC6 5267.	CF8M 5264.		PN 10/16	PN 25	PN 40	PN 63	PN 100	PN 160	PN 250	PN 320	PN 400	PN 10		PN 16	PN 25	PN 40	PN 63				
1 D 2	300 x 150 <sup>1)</sup>	002*	501*	006*	011*	25	H47	H47	H47	-	-	-	-	-	-	-	50	H15	H15	H15	H15	-			
1 D 2	600 x 150	003*	502*	007*	012*	25	-	-	-	H11	H11	-	-	-	-	50	H15	H15	H15	H15	-				
1½ D 2	1500 x 300	004*	503*	008*	013*	40	-	-	-	-	-	H11	H12	-	-	50	H15	H15	H15	H15	-				
1½ D 3	2500 x 300	005*	504*	009*	014*	40	-	-	-	-	-	-	H12	H13	-	80	H15	H15	H15	H15	H16				
1 E 2	300 x 150 <sup>1)</sup>	016*	506*	020*	025*	25	H47	H47	H47	-	-	-	-	-	-	50	H15	H15	H15	H15	-				
1 E 2	600 x 150	017*	507*	021*	026*	25	-	-	-	H11	H11	-	-	-	-	50	H15	H15	H15	H15	-				
1½ E 2	1500 x 300	018*	508*	022*	027*	40	-	-	-	-	-	H11	H12	-	-	50	H15	H15	H15	H15	-				
1½ E 3	2500 x 300	019*	509*	023*	028*	40	-	-	-	-	-	-	H12	H13	-	80	H15	H15	H15	H15	H16				
1½ F 2	300L x 150	030*	511*	-	040*	40	H47	-	-	-	-	-	-	-	-	50	H15	H15	H15	H15	-				
1½ F 2	300 x 150	031*	512*	035*	041*	40	-	H47	H47	-	-	-	-	-	-	50	H15	H15	H15	H15	-				
1½ F 2	600 x 150	032*	513*	036*	042*	40	-	H47	H47	-	-	-	-	-	-	50	H15	H15	H15	H15	-				
1½ F 3	1500 x 300	033*	514*	037*	043*	40	-	-	-	H11	H11	H11	H12	-	-	80	H15	H15	H15	H15	H16				
1½ F 3	2500 x 300	034*	515*	038*	044*	40	-	-	-	-	-	-	H12	H13	-	80	H15	H15	H15	H15	H16				
1½ G 3	300L x 150	046*	517*	-	111*	40	H47	-	-	-	-	-	-	-	-	50	H15	H15	H15	H15	-				
1½ G 3	300 x 150	047*	518*	052*	112*	40	-	H47	H47	H11	-	-	-	-	-	50	H15	H15	H15	H15	-				
1½ G 3	600 x 150	048*	519*	053*	113*	40	-	-	-	H11	H11	H11	-	-	-	50	H15	H15	H15	H15	-				
1½ G 3	900 x 300	049*	520*	054*	114*	40	-	-	-	-	H11	H11	-	-	-	80	H15	H15	H15	H15	H16				
2 G 3	1500 x 300	050*	521*	055*	115*	40	-	-	-	-	-	-	H12	H13	-	80	H15	H15	H15	H15	H16				
2 G 3	2500 x 300	051*	522*	056*	116*	40	-	-	-	-	-	-	-	-	H14	80	H15	H15	H15	H15	H16				
1½ H 3	300L x 150	143*	524*	-	153*	40	H47	H47	H47	-	-	-	-	-	-	50	H15	H15	H15	H15	-				
2 H 3	300 x 150	144*	525*	148*	154*	50	-	-	H47	H10	-	-	-	-	-	50	H15	H15	H15	H15	-				
2 H 3	600 x 150	-	-	149*	-	50	-	-	H47	H10	-	-	-	-	-	50	H15	H15	H15	H15	-				
2 H 3	600 x 150	145*	526*	-	155*	50	-	-	H47	H10	-	-	-	-	-	80	H15	H15	H15	H15	H16				
2 H 3	900 x 150	146*	527*	150*	156*	50	-	-	-	-	H11	H11	-	-	-	80	H15	H15	H15	H15	H16				
2 H 3	1500 x 300	147*	528*	151*	157*	50	-	-	-	-	-	H11	H12	-	-	80	H15	H15	H15	H15	H16				
2 J 3	300L x 150	163*	530*	-	197*	50	H47	H47	H47	H10	-	-	-	-	-	80	H15	H15	H15	H15	-				
3 J 4	600 x 150	165*	532*	169*	199*	80	-	-	H47	H10	-	-	-	-	-	100	H51	H51	H51	H51	-				
3 J 4	900 x 150	166*	533*	170*	200*	80	-	-	-	-	H11	H11	-	-	-	100	H51	H51	H15	H15	H16				
3 J 4	1500 x 300	167*	534*	171*	201*	80	-	-	-	-	-	H11	H12	-	-	100	H51	H51	H15	H15	H16				

<sup>1)</sup> 300L x 150 is available with the same Article-No. Note: Flange drillings and facings meet always the requirements of mentioned flange standards. Flange thickness and outer diameter may be thicker and wider than flange standard. For correct selection of bolting please refer to LWN 007-01. The inlet pressure size CL150 is not considered, please switch to inlet pressure size CL300 or CL300L.

## Flange drillings

### Flange drillings

according to DIN EN 1092-1

Standard API 526		Article-No.					Flange drillings															
Valve size	Flange class	Material				Inlet NPS [DN]	Inlet										Outlet NPS [DN]	Outlet				
		WCB 5262.	LCB 5263.	WC6 5267.	CF8M 5264.		PN 10/16	PN 25	PN 40	PN 63	PN 100	PN 160	PN 250	PN 320	PN 400	PN 10		PN 16	PN 25	PN 40	PN 63	
3 K 4	300 x 150 <sup>1)</sup>	203*	536*	207*	212*	80	H47	H47	H47	H10	-	-	-	-	-	100	H51	H51	H15	H15	-	
3 K 4	600 x 150	204*	537*	208*	213*	80	-	-	H47	H10	-	-	-	-	-	100	H51	H51	H15	H15	-	
3 K 6	900 x 150	-	-	209*	-	80	-	-	-	H10	H11	H11	H12	-	-	150	H51	H51	-	-	-	
3 K 6	900 x 150	205*	538*	-	214*	80	-	-	-	H10	H11	H11	H12	-	-	150	H51	H51	H15	H15	-	
3 K 6	1500 x 300	206*	539*	210*	215*	80	-	-	-	H10	H11	H11	H12	-	-	150	H51	H51	H15	H15	-	
3 L 4	300L x 150	233*	541*	-	243*	80	H47	H47	H47	H10	-	-	-	-	-	100	H15	H15	H15	H15	-	
4 L 6	300 x 150	234*	542*	238*	244*	100	H45	H47	H47	H10	-	-	-	-	-	150	H51	H51	-	-	-	
4 L 6	600 x 150	235*	543*	239*	245*	100	-	-	-	H10	H11	H11	-	-	-	150	H51	H51	-	-	-	
4 L 6	900 x 150	236*	544*	240*	246*	100	-	-	-	-	H11	H11	-	-	-	150	H51	H51	-	-	-	
4 L 6	1500 x 300	237*	545*	241*	-	100	-	-	-	-	-	-	H12	-	-	150	H51	H51	-	-	-	
4 M 6	300 x 150 <sup>1)</sup>	581*	547*	584*	588*	100	H45	H47	H47	H10	-	-	-	-	-	150	H51	H51	-	-	-	
4 M 6	600 x 150	582*	548*	585*	589*	100	-	-	-	H10	H11	H11	-	-	-	150	H51	H51	-	-	-	
4 M 6	900 x 150	583*	549*	586*	-	100	-	-	-	-	H11	H11	H12	-	-	150	H51	H51	-	-	-	
4 N 6	300L x 150 <sup>1)</sup>	591*	551*	594*	598*	100	H45	H47	H47	H10	-	-	-	-	-	150	H51	H51	-	-	-	
4 N 6	600 x 150	592*	552*	595*	599*	100	-	-	-	-	H11	H11	-	-	-	150	H51	H51	-	-	-	
4 N 6	900 x 150	593*	553*	596*	-	100	-	-	-	-	-	-	H12	-	-	150	H51	H51	-	-	-	
4 P 6	300L x 150	646*	555*	-	654*	100	H45	H47	H47	-	-	-	-	-	-	150	H51	H51	-	-	-	
4 P 6	300 x 150	647*	556*	550*	655*	100	-	H47	H47	-	-	-	-	-	-	150	H51	H51	-	-	-	
4 P 6	600 x 300	648*	557*	551*	656*	100	-	-	-	H10	H11	-	-	-	-	150	H51	H51	-	-	-	
4 P 6	900 x 300	649*	558*	552*	-	100	-	-	-	-	-	H11	H12	-	-	150	H51	H51	-	-	-	
6 Q 8	300 x 150	658*	560*	660*	663*	150	H45	H47	H47	-	-	-	-	-	-	200	H50	H51	H52	-	-	
6 Q 8	600 x 150	659*	561*	661*	664*	150	-	-	-	H10	H11	H11	-	-	-	200	H50	H51	H52	-	-	
6 R 8	300L x 150	666*	563*	669*	672*	150	H45	H47	H47	H10	-	-	-	-	-	200	H50	H51	H52	-	-	
6 R 10	300 x 150	667*	564*	-	673*	150	-	-	H47	H10	-	-	-	-	-	250	H50	H51	-	-	-	
6 R 10	600 x 150	668*	565*	670*	674*	150	-	-	H47	H10	-	-	-	-	-	250	H50	H51	-	-	-	
8 T 10	300 x 150 <sup>1)</sup>	676*	567*	677*	679*	200	-	H46	H47	-	-	-	-	-	-	250	H50	H51	-	-	-	

<sup>1)</sup> 300L x 150 is available with the same Article-No. Note: Flange drillings and facings meet always the requirements of mentioned flange standards. Flange thickness and outer diameter may be thicker and wider than flange standard. For correct selection of bolting please refer to LWN 007-01. The inlet pressure size CL150 is not considered, please switch to inlet pressure size CL300 or CL300L.

# Type 526

## How to order Type 526 with outlet flange rating class 300

For customer specifications requiring a flange rating class 300 at the outlet LESER provides Type 526 with outlet flange rating class 300. For ordering please state the article numbers and option codes which are listed in the table.

### Outlet with flange class 300

Orifice	Valve size Inlet x Outlet Center to face a x b	Body material	300 x 300		600 x 300	
			Art.-No.	Option code	Art.-No.	Option code
D	1" x 2"	WCB 1.0619	4582.610X	H65, H80, J18, J51	4582.610X	H67, H80, J18, J51
		CF10M 1.4581	4584.620X	H65, H80, J18, J51	4584.620X	H67, H80, J18, J51
	4 5/7" x 5 1/3"	WC6 1.7357 LCB	4587.630X -	H65, H80, J18, J51 -	4587.630X -	H67, H80, J18, J51 -
D	1 1/2" x 2"	WCB 1.0619	5262.004X	H65, H80	5262.004X	H67, H80
		CF8M 1.4408	5264.013X	H65, H80	5264.013X	H67, H80
	4 1/8" x 5 1/2"	WC6 1.7357 LCB	5267.008X 5263.503X	H65, H80 H65, H80	5267.008X 5263.503X	H67, H80 H67, H80
E	1" x 2"	WCB 1.0619	4582.610X	H65, H80, J18, J51	4582.610X	H67, H80, J18, J51
		CF10M 1.4581	4584.620X	H65, H80, J18, J51	4584.620X	H67, H80, J18, J51
	4 5/7" x 5 1/3"	WC6 1.7357 LCB	4587.630X -	H65, H80, J18, J51 -	4587.630X -	H67, H80, J18, J51 -
E	1 1/2" x 2"	WCB 1.0619	5262.018X	H65, H80	5262.018X	H67, H80
		CF8M 1.4408	5264.027X	H65, H80	5264.027X	H67, H80
	4 1/8" x 5 1/2"	WC6 1.7357 LCB	5267.022X 5263.508X	H65, H80 H65, H80	5267.022X 5263.508X	H67, H80 H67, H80
F	1 1/2" x 2"	WCB 1.0619	5262.031X	H65, H80	5262.032X	H67, H80
		CF8M 1.4408	5264.041X	H65, H80	5264.041X	H67, H80
	4 7/8" x 6"	WC6 1.7357 LCB	5267.035X 5263.512X	H65, H80 H65, H80	5267.036X 5263.512X	H67, H80 H67, H80
G	1 1/2" x 3"	WCB 1.0619	5262.049X	H65, H80	5262.049X	H67, H80
		CF8M 1.4408	5264.114X	H65, H80	5264.114X	H67, H80
	4 7/8" x 6 1/2"	WC6 1.7357 LCB	5267.054X 5263.520X	H65, H80 H65, H80	5267.054X 5263.520X	H67, H80 H67, H80
H	2" x 3"	WCB 1.0619	5262.146X	H65, H80	5262.146X	H67, H80
		CF8M 1.4408	5264.156X	H65, H80	5264.156X	H67, H80
	6 1/16" x 6 3/8"	WC6 1.7357 LCB	5267.150X 5263.527X	H65, H80 H65, H80	5267.150X 5263.527X	H67, H80 H67, H80
J	3" x 4"	WCB 1.0619	5262.166X	H65, H80	5262.166X	H67, H80
		CF8M 1.4408	5264.200X	H65, H80	5264.200X	H67, H80
	7 1/4" x 7 1/8"	WC6 1.7357 LCB	5267.170X 5263.533X	H65, H80 H65, H80	5267.170X 5263.533X	H67, H80 H67, H80
K	3" x 4"	WCB 1.0619	5262.204X	H65, H80	5262.204X	H67, H80
		CF8M 1.4408	5264.213X	H65, H80	5264.213X	H67, H80
	7 1/4" x 7 1/8"	WC6 1.7357 LCB	5267.209X 5263.537X	H65, H80 H65, H80	5267.209X 5263.537X	H67, H80 H67, H80
L	4" x 6"	WCB 1.0619	5262.235X	H65, H80	5262.235X	H67, H80
		CF8M 1.4408	5264.245X	H65, H80	5264.245X	H67, H80
	7 3/4" x 8 1/2"	WC6 1.7357 LCB	5267.239X 5263.543X	H65, H80 H65, H80	5267.239X 5263.543X	H67, H80 H67, H80
M	4" x 6"	WCB 1.0619	5262.582X	H65, H80	5262.582X	H67, H80
		CF8M 1.4408	5264.589X	H65, H80	5264.589X	H67, H80
	7 3/4" x 8 1/2"	WC6 1.7357 LCB	5267.585X 5263.548X	H65, H80 H65, H80	5267.585X 5263.548X	H67, H80 H67, H80
N	4" x 6"	WCB 1.0619	5262.592X	H65, H80	5262.592X	H67, H80
		CF8M 1.4408	5264.599X	H65, H80	5264.599X	H67, H80
	7 3/4" x 8 1/2"	WC6 1.7357 LCB	5267.595X 5263.552X	H65, H80 H65, H80	5267.595X 5263.552X	H67, H80 H67, H80
P	4" x 6" Welded outlet flange	WCB 1.0619	5262.647X	S01	5262.647X	S01
		CF8M 1.4408	5264.655X	S01	5264.655X	S01
	8 7/8" x 11 5/8"	WC6 1.7357 LCB	5267.650X 5263.556X	S01 S01	5267.650X 5263.556X	S01 S01
Q	6" x 8" Welded outlet flange	WCB 1.0619	5262.658X	S01	5262.658X	S01
		CF8M 1.4408	5264.663X	S01	5264.663X	S01
	9 7/16" x 12"	WC6 1.7357 LCB	5267.660X 5263.560X	S01 S01	5267.660X 5263.560X	S01 S01
R	6" x 10" Welded outlet flange	WCB 1.0619	5262.667X	S01	5262.667X	S01
		CF8M 1.4408	5264.673X	S01	5264.673X	S01
	9 7/16" x 13 1/5"	WC6 1.7357 LCB	5267.670X 5263.564X	S01 S01	5267.670X 5263.564X	S01 S01
T	8" x 10" Welded outlet flange	WCB 1.0619	5262.676X	S01		
		CF8M 1.4408	5264.679X	S01		
	10 7/8" x 13 1/5"	WC6 1.7357 LCB	5267.677X 5263.567X	S01 S01		

Note: Option code J51 (Lift restriction) not approved for ASME-applications.

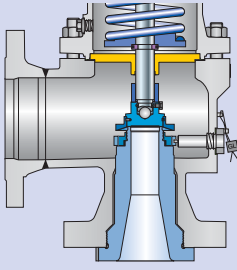
Orifice	900 x 300		1500 x 300		2500 x 300							
	Art.-No.	Option code	Art.-No.	Option code	Art.-No.	Option code						
D	Outlet flange rating class 300 is standard flange rating class acc. to API standard 526											
D												
E												
E												
F												
G												
H							5262.147X	Class 1500 x 300				
							5264.157X					
							5267.151X					
							5263.528X					
J	5262.166X	H68, H80										
	5264.200X	H68, H80										
	5267.170X	H68, H80										
	5263.533X	H68, H80										
K	5262.204X	H68, H80										
	5264.213X	H68, H80										
	5267.209X	H68, H80										
	5263.537X	H68, H80										
L	Welded outlet flange rating class 300 available on request.											
M			<b>Design details</b> <b>Orifice D and E:</b> 1 D 2 and 1 E 2 class 300 x 300 and 600 x 300 are realised by a modification of Type 458 DN 25 / 1". <b>Orifice L:</b> 4 L 6 class 900 x 300 and 1500 x 300 can be realised by a welded outlet flange on request. <b>Orifice M – P:</b> 4 M 6, 4 N 6 and 4 P 6 class 900 x 300 can be realised by a welded outlet flange on request. <b>Orifice P – T:</b> 4 P 6 up to 8 T 10 are realised by a welded outlet flange class 300.									
N												
P												
Q			<b>Center to face dimensions:</b> The center to face dimensions a and b for LESER Type 526 with outlet flange rating class 300 are not specified in API Standard 526. The actual dimensions are listed in the table. They differ from the dimensions which are specified in API 526 for safety valves with outlet flange class 150. Exceptions are the grey marked safety valves.									
R												
T	Grey marked safety valves The center to face dimensions are equal to API standard 526 with outlet flange rating class 150.											

## Flange facings

Type 526

Flange facings				
Indication	Standard	Inlet	Outlet	Remark
<b>General</b>				
Flange undrilled	-	H38	H39	
Linde-V-Nut, Form V48	Linde Standard 420-08 LWN 313.36	J07	J08	Groove: Rz 16
Linde-V-Nut, Form V48A		J05	J06	Groove: Rz 4, e.g. with hydrogen
Lens seal form L (without sealing lens)	DIN 2696 LWN 313.35	J11	J12	

Acc. to DIN EN 1092						
Flange facing (see also LWN 313.40)		Inlet		Outlet		Remark
		PN 10 – PN 40	PN 63 – PN 400	PN 10 – PN 40	PN 63	Rz-data according to DIN EN 1092 in µm
Raised face	Type B1	*	–	*	–	Facing: Rz = 12.5 – 50
	Type B2	L36	*	L38	*	Facing: Rz = 3.2 – 12.5
Tongue face C <sup>1)</sup>		S05		H92		
Groove face D <sup>1)</sup>		S05		H91		
Male face E		S05		H98		
Female face F		S05		H99		
O-ring male face G		S05		S01		
O-ring female face H		S05		S01		

Acc. to ASME B16.5													
Body material	Inlet	Outlet	Smooth finish <sup>2)</sup>		Serrated finish		RTJ-groove						
			Inlet	Outlet	Inlet	Outlet	Inlet				Outlet		
			Option code	Option code	Option code	Option code	CL300	CL600	CL900	CL1500	CL2500	CL150	CL300
all	all	all	L52	L53	*	*	L58						H63

- <sup>1)</sup> According to DIN EN 1092 groove depths and tongue heights increased compared to the formerly valid DIN (refer to LWN 313.40).  
LESER manufactures the groove at flanged valves by milling. If a customer demands a turned surface in the soil of the groove according to DIN 2512 and / or DIN EN 1092-1 an additional option code is necessary: "S01: bottom of the groove drilled". Groove and tongue for PN160 flanges refer to DIN 2512 / LWN 313.32.
- <sup>2)</sup> Smooth finish is not defined in the effective standards. For LESER's definition for smooth finish see page 00/05.

For signs and symbols refer to page 00/05

Note: Flange drillings and facings meet always the requirements of mentioned flange standards. Flange thickness and outer diameter may vary from flange standard.

### Stud-bolts length for flange connection inlet and outlet

All LESER safety valves Type 526 need at the inlet side longer stud-bolts for the flange connections as stated in ASME B16.5, due to the full nozzle design. Furthermore, due to the actual castings the stud bolts at the outlet can differ from ASME B16.5 as well.  
LESER state the stud-bolt length in LWN 001.29-E. For calculation of stud-bolts length the measure "s" stated on page 01/10-01/13 can be used.

Connection acc. to API Standard 526 – 1984					
Orifice	Valve size		Flange rating class		Option code
	Inlet	Outlet	Inlet		
D / E	1 1/2"	3" drilled 2 1/2"	CL2500		S01
F	1 1/2"	3" drilled 2 1/2"	CL900		S01
G	1 1/2"	3" drilled 2 1/2"	CL150 – 900		S01
J	2 1/2"	4"	CL900 – 1500		S01
K	2 1/2"	6"	CL900 – 1500		S01

## Spare parts – Components

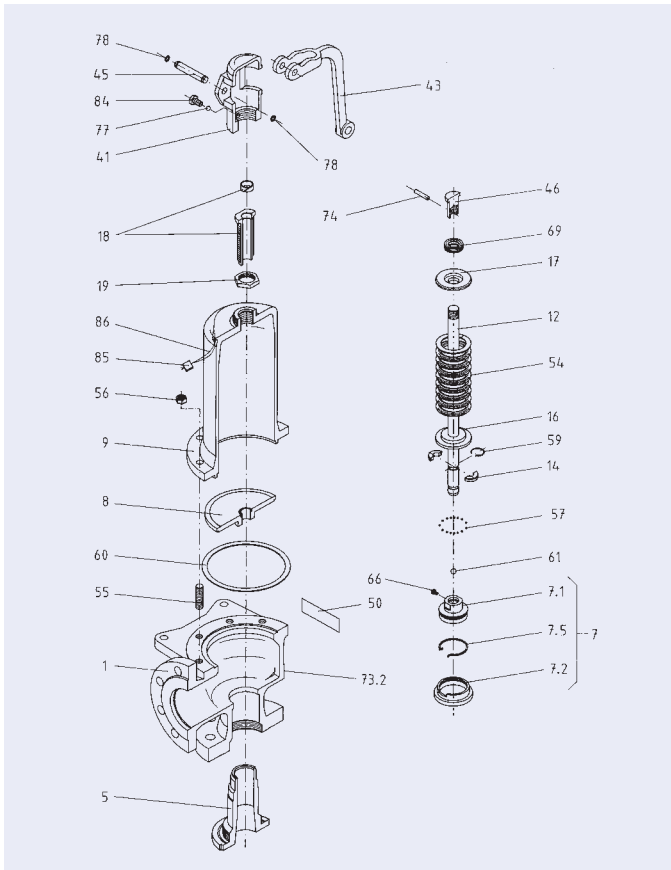

Materials	
Item	Component
5	Nozzle
7	Disc
7.5	Securing ring (Disc)
14	Split ring
57	Ball
59	Securing ring
60	Gasket
61	Ball
66	Screw
69	Axial needle bearing
73.2	Gasket (Lock screw)

Type 526

## Spare parts recommendations

The following recommendations for spare parts should be taken as a guideline. The actual needs for the replacement of parts depend on various conditions like

- operating temperature
- set pressure and operating pressure
- medium
- environment
- material selection

These operating conditions have a significant influence on the product life of safety relief valves.

Item	Component	Commission / start-up	Two year operating	Five year operating
	Spare part kit	1 per valve	1 per valve	2 per valve
5	Nozzle	0	0	1 per 5 valves
7	Disc	1 per 5 valves	2 per 5 valves	1 per valve
12	Spindle	0	0	1 per 5 valves
15	Balanced bellows	1 per 5 valves	2 per 5 valves	1 per valve

1 per valve: per each supplied safety valve one piece shall be provided  
 1 per 5 valves: one spare part per 5 supplied equal safety valves

## Rework of seat and disc

Minor damages on the seating surfaces of nozzle and disc can be repaired by lapping or by machining and successive lapping. For this purpose LESER offers the standard tool kit (Art.-No. 0160.0000).

## Spare parts – Spare part kits

The spare part kit provides all spare parts which are recommended by LESER to be replaced during rework of a safety valve.

### Materials

Item	Component	Material	Quantity
7.5	Securing ring (Disc)	1.4571	1
		316Ti	
14	Split ring	1.4404	2
		316L	
57	Ball	1.4401	15
		316	
59	Securing ring <sup>1)</sup>	1.4571	1
		316Ti	
60	Gasket <sup>2)</sup>	Graphit/ 1.4401	3
		Graphit/ 316	
61	Ball	1.4401	1
		316	
66	Screw	1.4401	1
		316	
73.2	Gasket (Lock screw)	1.4401	1
		316	

<sup>1)</sup> Kits 5012.1118 and 5012.1119: Kits don't contain securing ring due to re-usable ring bush in the safety valve.

<sup>2)</sup> Kit 50112.1109: Three additional gaskets are enclosed for use in type 5267 (WC6).

### Spare part kit

Orifice	Inlet flange rating class of the safety valve						
	CL150	CL300L	CL300	CL600	CL900	CL1500	CL2500
D	5012.1101				5012.1102		
E	5012.1101				5012.1102		
F	5012.1103						
G	5012.1104						
H	5012.1105		5012.1106				
J	5012.1107		5012.1108				
K	5012.1109				5012.1110		
L	5012.1111		5012.1112				
M	5012.1113						
N	5012.1114						
P	5012.1115		5012.1116				
Q	5012.1117						
R	5012.1118		5012.1119				
T	5012.1120						

## Spare parts – Disc (Item 7) Metal to metal seat

Disc (Item 7)		Metal to metal seat						
Orifice	Disc material	Flange rating class						
		150 x 150	300L x 150	300 x 150	600 x 150	900 x 300	1500 x 300	2500 x 300
Body material: WCB 1.0619, LCB, WC6 1.7357		Material-No.						
D	Hardened stainless steel 1.4122	225.0439.9000	225.0439.9000	225.0439.9000	225.0439.9000	225.0539.9000	225.0539.9000	225.0639.9000
E		225.0439.9000	225.0439.9000	225.0439.9000	225.0439.9000	225.0539.9000	225.0539.9000	225.0639.9000
F		225.0739.9000	225.0739.9000	225.0739.9000	225.0739.9000	225.0739.9000	225.0739.9000	225.0839.9000
G		225.1139.9000	225.1139.9000	225.1139.9000	225.1139.9000	225.1139.9000	225.1139.9000	225.1439.9000
Orifice	Disc material	Flange rating class						
		150 x 150	300L x 150	300 x 150	600 x 150	900 x 150	1500 x 300	
H	Hardened stainless steel 1.4122	225.1539.9000	225.1539.9000	225.1639.9000	225.1639.9000	225.1639.9000	225.1639.9000	225.1639.9000
J		225.1839.9000	225.1839.9000	225.1939.9000	225.1939.9000	225.1939.9000	225.1939.9000	225.1939.9000
K		225.2139.9000	225.2139.9000	225.2139.9000	225.2139.9000	225.2139.9000	225.2139.9000	225.2139.9000
Orifice	Disc material	Flange rating class						
		150 x 150	300L x 150	300 x 150	600 x 150	900 x 150	1500 x 150	
L	Hardened stainless steel 1.4122	225.2539.9000	225.2539.9000	225.2639.9000	225.2639.9000	225.2639.9000	225.2639.9000	225.2639.9000
M		225.2939.9000	225.2939.9000	225.2939.9000	225.2939.9000	225.2939.9000		
N		225.3239.9000	225.3239.9000	225.3239.9000	225.3239.9000	225.3239.9000		
P		225.3439.9000	225.3439.9000	225.3539.9000	225.3539.9000	225.3539.9000		
Q		225.3939.9000	225.3939.9000	225.3939.9000	225.3639.9000			
R		225.3739.9000	225.3739.9000	225.3839.9000	225.3839.9000			
T		225.3939.9000	225.3939.9000	225.3939.9000				

Orifice	Disc material	Flange rating class						
		150 x 150	300L x 150	300 x 150	600 x 150	900 x 300	1500 x 300	2500 x 300
Body material: CF8M 1.4408		Material-No.						
D	316L stellited 1.4404 stellited	225.0469.9000	225.0469.9000	225.0469.9000	225.0469.9000	225.0569.9000	225.0569.9000	225.0669.9000
E		225.0469.9000	225.0469.9000	225.0469.9000	225.0469.9000	225.0569.9000	225.0569.9000	225.0669.9000
F		225.0769.9000	225.0769.9000	225.0769.9000	225.0769.9000	225.0769.9000	225.0769.9000	225.0869.9000
G		225.1169.9000	225.1169.9000	225.1169.9000	225.1169.9000	225.1169.9000	225.1169.9000	225.1469.9000
Orifice	Disc material	Flange rating class						
		150 x 150	300L x 150	300 x 150	600 x 150	900 x 150	1500 x 300	
H	316L stellited 1.4404 stellited	225.1569.9000	225.1569.9000	225.1669.9000	225.1669.9000	225.1669.9000	225.1669.9000	225.1669.9000
J		225.1869.9000	225.1869.9000	225.1969.9000	225.1969.9000	225.1969.9000	225.1969.9000	225.1969.9000
K		225.2169.9000	225.2169.9000	225.2169.9000	225.2169.9000	225.2169.9000	225.2169.9000	225.2169.9000
Orifice	Disc material	Flange rating class						
		150 x 150	300L x 150	300 x 150	600 x 150	900 x 150	1500 x 150	
L	316L stellited 1.4404 stellited	225.2569.9000	225.2569.9000	225.2669.9000	225.2669.9000	225.2669.9000		-
M		225.2969.9000	225.2969.9000	225.2969.9000	225.2969.9000			
N		225.3269.9000	225.3269.9000	225.3269.9000	225.3269.9000			
P		225.3469.9000	225.3469.9000	225.3569.9000	225.3569.9000			
Q		225.3669.9000	225.3669.9000	225.3669.9000	225.3669.9000			
R		225.3769.9000	225.3769.9000	225.3869.9000	225.3869.9000			
T		225.3969.9000	225.3969.9000	225.3969.9000				



## Spare parts – Disc (Item 7) Soft seal and O-ring (Item 7.4) Soft seal

Type 526

Disc (Item 7)		Soft seal: Material 316L 1.4404						
Orifice	Body material	Flange rating class						Material-No.
		150 x 150	300L x 150	300 x 150	600 x 150	900 x 300	1500 x 300	
D	all	205.0149.90X1	205.0149.90X1	205.0149.90X1	205.0149.90X1	205.0249.90X1	205.0249.90X1	205.0249.90X1
E		205.0149.90X1	205.0149.90X1	205.0149.90X1	205.0149.90X1	205.0249.90X1	205.0249.90X1	205.0249.90X1
F		205.0349.90X1	205.0349.90X1	205.0349.90X1	205.0349.90X1	205.0349.90X1	205.0349.90X1	205.0349.90X1
G		205.0649.90X1	205.0649.90X1	205.0649.90X1	205.0649.90X1	205.0649.90X1	205.0649.90X1	205.0649.90X1
Orifice	Body material	Flange rating class						Material-No.
		150 x 150	300L x 150	300 x 150	600 x 150	900 x 150	1500 x 300	
H	all	205.0849.90X1	205.0849.90X1	205.0949.90X1	205.0949.90X1	205.1049.90X1	205.1049.90X1	205.1049.90X1
J		205.1149.90X1	205.1149.90X1	205.1249.90X1	205.1249.90X1	205.1249.90X1	205.1249.90X1	205.1249.90X1
K		205.1349.90X1	205.1349.90X1	205.1349.90X1	205.1349.90X1	205.1349.90X1	205.1349.90X1	205.1349.90X1
Orifice	Body material	Flange rating class						Material-No.
		150 x 150	300L x 150	300 x 150	600 x 150	900 x 150	1500 x 150	
L	all	205.1649.90X1	205.1649.90X2	205.1749.90X3	205.1749.90X1	205.1749.90X1	205.1749.90X1	
M		205.1949.90X1	205.1949.90X1	205.1949.90X1	205.1949.90X1	205.1949.90X1	205.1949.90X1	
N		205.2149.90X1	205.2149.90X1	205.2149.90X1	205.2149.90X1	205.2149.90X1	205.2149.90X1	
P		205.2349.90X1	205.2349.90X1	205.2449.90X1	205.2449.90X1	205.2449.90X1	205.2449.90X1	
Q		205.2549.90X1	205.2549.90X1	205.2549.90X1	205.2549.90X1	205.2549.90X1	205.2549.90X1	
R		205.2649.90X1	205.2649.90X1	205.2649.90X1	205.2649.90X1	205.2649.90X1	205.2649.90X1	
T		205.2849.90X1	205.2849.90X1	205.2849.90X1	205.2849.90X1	205.2849.90X1	205.2849.90X1	

O-ring (Item 7.4)		Soft seal						
Orifice	Body material	Flange rating class						Material-No.
		150 x 150	300L x 150	300 x 150	600 x 150	900 x 300	1500 x 300	
D	all	502.0171.26X1	502.0171.26X1	502.0171.26X1	502.0171.26X1	502.0171.26X1	502.0171.26X1	502.0171.26X1
E		502.0171.26X1	502.0171.26X1	502.0171.26X1	502.0171.26X1	502.0171.26X1	502.0171.26X1	502.0171.26X1
F		502.0202.26X1	502.0202.26X1	502.0202.26X1	502.0202.26X1	502.0202.26X1	502.0202.26X1	502.0202.26X1
G		502.0249.35X1	502.0249.35X1	502.0249.35X1	502.0249.35X1	502.0249.35X1	502.0249.35X1	502.0249.35X1
Orifice	Body material	Flange rating class						Material-No.
		150 x 150	300L x 150	300 x 150	600 x 150	900 x 150	1500 x 300	
H	all	502.0313.35X1	502.0313.35X1	502.0313.35X1	502.0313.35X1	502.0313.35X1	502.0313.35X1	502.0313.35X1
J		502.0408.35X1	502.0408.35X1	502.0408.35X1	502.0408.35X1	502.0408.35X1	502.0408.35X1	502.0408.35X1
K		502.0472.35X1	502.0472.35X1	502.0472.35X1	502.0472.35X1	502.0472.35X1	502.0472.35X1	502.0472.35X1
Orifice	Body material	Flange rating class						Material-No.
		150 x 150	300L x 150	300 x 150	600 x 150	900 x 150	1500 x 150	
L	all	502.0567.35X1	502.0567.35X1	502.0567.35X1	502.0567.35X1	502.0567.35X1	502.0567.35X1	
M		502.0628.35X1	502.0628.35X1	502.0628.35X1	502.0628.35X1	502.0628.35X1	502.0628.35X1	
N		502.0692.53X1	502.0692.53X1	502.0692.53X1	502.0692.53X1	502.0692.53X1	502.0692.53X1	
P		502.0850.35X1	502.0850.35X1	502.0850.35X1	502.0850.35X1	502.0850.35X1	502.0850.35X1	
Q		502.1104.53X1	502.1104.53X1	502.1104.53X1	502.1104.53X1	502.1104.53X1	502.1104.53X1	
R		502.1327.35X1	502.1327.35X1	502.1327.35X1	502.1327.35X1	502.1327.35X1	502.1327.35X1	
T		502.1644.35X1	502.1644.35X1	502.1644.35X1	502.1644.35X1	502.1644.35X1	502.1644.35X1	

<b>O-ring material code:</b>	D (EPDM)	X: 4
	K (CR)	X: 5
	L (FPM)	X: 7
	C (FFKM)	X: 9
<b>Durometer:</b>	70 – 75 IHRD	

## Spare parts – Nozzle (Item 5)

Nozzle (Item 5)		Flange rating class						
Orifice	Nozzle material	150 x 150	300L x 150	300 x 150	600 x 150	900 x 300	1500 x 300	2500 x 300
<b>Body material: WCB / 1.0619, LCB</b>		<b>Material-No.</b>						
D	CF8M 1.4408	207.2049.9000	207.2049.9000	207.2049.9000	207.2069.9000	207.2269.9000	207.2269.9000	207.2769.9000
E	CF8M 1.4408	207.2049.9000	207.2049.9000	207.2049.9000	207.2069.9000	207.2269.9000	207.2269.9000	207.2769.9000
F	CF8M 1.4408	207.2349.9000	207.2349.9000	207.2349.9000	207.2369.9000	207.2369.9000	207.2369.9000	207.2869.9000
G	CF8M 1.4408	207.2449.9000	207.2449.9000	207.2449.9000	207.2469.9000	207.2469.9000	207.3269.9000	207.3269.9000
Orifice	Nozzle material	Flange rating class						
		150 x 150	300L x 150	300 x 150	600 x 150	900 x 150	1500 x 300	
H	CF8M 1.4408	207.2549.9000	207.2549.9000	207.2949.9000	207.3169.9000	207.3169.9000	207.3169.9000	
J	CF8M 1.4408	207.3049.9000	207.3049.9000	207.3569.9000	207.3569.9000	207.3569.9000	207.3569.9000	
K	CF8M 1.4408	207.3349.9000	207.3349.9000	207.3349.9000	207.3669.9000	207.4169.9000	207.4269.9000	
Orifice	Nozzle material	Flange rating class						
		150 x 150	300L x 150	300 x 150	600 x 150	900 x 150	1500 x 150	
L	CF8M 1.4408	207.3449.9000	207.3449.9000	207.3769.9000	207.3769.9000	207.4369.9000	207.4369.9000	
M	CF8M 1.4408 stell.	207.3869.9000	207.3869.9000	207.3869.9000	207.3869.9000	207.4469.9000		
N	CF8M 1.4408 stell.	207.4069.9000	207.4069.9000	207.4069.9000	207.4069.9000	207.4069.9000		
P	CF8M 1.4408 stell.	207.4569.9000	207.4569.9000	207.4669.9000	207.4669.9000	207.4669.9000		
Q	CF8M 1.4408 stell.	207.4769.9000	207.4769.9000	207.4769.9000	207.4769.9000			
R	CF8M 1.4408 stell.	207.4869.9000	207.4869.9000	207.5769.9000	207.5769.9000			
T	CF8M 1.4408 stell.	207.5969.9000	207.5969.9000	207.5969.9000				

Orifice	Nozzle material	Flange rating class						
		150 x 150	300L x 150	300 x 150	600 x 150	900 x 300	1500 x 300	2500 x 300
<b>Body material: WC6 / 1.7357</b>		<b>Material-No.</b>						
D	CF8M 1.4408 stell.	–	–	207.2069.9000	207.2069.9000	207.2269.9000	207.2269.9000	207.2769.9000
E	CF8M 1.4408 stell.	–	–	207.2069.9000	207.2069.9000	207.2269.9000	207.2269.9000	207.2769.9000
F	CF8M 1.4408 stell.	–	–	207.2369.9000	207.2369.9000	207.2369.9000	207.2369.9000	207.2869.9000
G	CF8M 1.4408 stell.	–	–	207.2469.9000	207.2469.9000	207.2469.9000	207.3269.9000	207.3269.9000
Orifice	Nozzle material	Flange rating class						
		150 x 150	300L x 150	300 x 150	600 x 150	900 x 150	1500 x 300	
H	CF8M 1.4408 stell.	–	–	207.2969.9000	207.2969.9000	207.3169.9000	207.3169.9000	
J	CF8M 1.4408 stell.	–	–	207.3569.9000	207.3569.9000	207.3569.9000	207.3569.9000	
K	CF8M 1.4408 stell.	–	–	207.3369.9000	207.3669.9000	207.3669.9000	207.4269.9000	
Orifice	Nozzle material	Flange rating class						
		150 x 150	300L x 150	300 x 150	600 x 150	900 x 150	1500 x 150	
L	CF8M 1.4408 stell.	–	–	207.3769.9000	207.3969.9000	207.4369.9000	207.4369.9000	
M	CF8M 1.4408 stell.	–	–	207.3869.9000	207.3869.9000	207.4469.9000		
N	CF8M 1.4408 stell.	–	–	207.4069.9000	207.4069.9000	207.4069.9000		
P	CF8M 1.4408 stell.	–	–	207.4669.9000	207.4669.9000	207.4669.9000		
Q	CF8M 1.4408 stell.	–	–	207.4769.9000	207.4769.9000			
R	CF8M 1.4408 stell.	–	207.4869.9000	207.5769.9000	207.5769.9000			
T	CF8M 1.4408 stell.	–	–	207.5969.9000				

LESER reserves to use the material 1.4404 / 316L alternatively.

<b>Material code:</b>	X: 4 not stellited
207.YYXY.9000	X: 6 stellited

## Spare parts – Nozzle (Item 5), Split Ring

Type 526

Nozzle (Item 5)		Flange rating class						
Orifice	Nozzle material	150 x 150	300L x 150	300 x 150	600 x 150	900 x 300	1500 x 300	2500 x 300
Body material: CF8M / 1.4408		Material-No.						
D	CF8M 1.4408	207.2049.9000	207.2049.9000	207.2049.9000	207.2049.9000	207.2269.9000	207.2269.9000	207.2769.9000
E	CF8M 1.4408	207.2049.9000	207.2049.9000	207.2049.9000	207.2049.9000	207.2269.9000	207.2269.9000	207.2769.9000
F	CF8M 1.4408	207.2349.9000	207.2349.9000	207.2349.9000	207.2349.9000	207.2369.9000	207.2369.9000	207.2869.9000
G	CF8M 1.4408	207.2449.9000	207.2449.9000	207.2449.9000	207.2449.9000	207.2469.9000	207.3269.9000	207.3269.9000
Orifice	Nozzle material	Flange rating class						
H	CF8M 1.4408	150 x 150	300L x 150	300 x 150	600 x 150	900 x 150	1500 x 300	
J	CF8M 1.4408	207.2549.9000	207.2549.9000	207.2949.9000	207.3169.9000	207.3169.9000	207.3169.9000	
K	CF8M 1.4408	207.3049.9000	207.3049.9000	207.3569.9000	207.3569.9000	207.3569.9000	207.3569.9000	
L	CF8M 1.4408	207.3349.9000	207.3349.9000	207.3349.9000	207.3669.9000	207.4169.9000	207.4269.9000	
Orifice	Nozzle material	Flange rating class						
M	CF8M 1.4408 stell.	150 x 150	300L x 150	300 x 150	600 x 150	900 x 150		
N	CF8M 1.4408 stell.	207.3449.9000	207.3449.9000	207.3769.9000	207.3769.9000	207.4369.9000		
P	CF8M 1.4408 stell.	207.3869.9000	207.3869.9000	207.3869.9000	207.3869.9000			
Q	CF8M 1.4408 stell.	207.4069.9000	207.4069.9000	207.4069.9000	207.4069.9000			
R	CF8M 1.4408 stell.	207.4569.9000	207.4569.9000	207.4669.9000	207.4669.9000			
T	CF8M 1.4408 stell.	207.4769.9000	207.4769.9000	207.4769.9000	207.4769.9000			
	CF8M 1.4408 stell.	207.4869.9000	207.4869.9000	207.5769.9000	207.5769.9000			
	CF8M 1.4408 stell.	207.5969.9000	207.5969.9000	207.5969.9000				

LESER reserves to use the material 1.4404 / 316L alternatively.

<b>Material code:</b>	X: 4 not stellited
207.YYXY.9000	X: 6 stellited

Split Ring (Item 14)		Material 316L 1.4404							
Orifice	Body material	Flange rating class							
		150 x 150	300L x 150	300 x 150	600 x 150	900 x 300	1500 x 300	2500 x 300	
		Material-No.							
D	all	251.0249.0000	251.0249.0000	251.0249.0000	251.0249.0000	251.0249.0000	251.0249.0000	251.0249.0000	
E		251.0249.0000	251.0249.0000	251.0249.0000	251.0249.0000	251.0249.0000	251.0249.0000	251.0249.0000	
F		251.0249.0000	251.0249.0000	251.0249.0000	251.0249.0000	251.0249.0000	251.0249.0000	251.0249.0000	
G		251.0249.0000	251.0249.0000	251.0249.0000	251.0249.0000	251.0249.0000	251.0349.0000	251.0349.0000	
Orifice	Body material	Flange rating class							
H	all	150 x 150	300L x 150	300 x 150	600 x 150	900 x 150	1500 x 300		
J		251.0249.0000	251.0249.0000	251.0349.0000	251.0349.0000	251.0349.0000	251.0349.0000		
K		251.0349.0000	251.0449.0000	251.0449.0000	251.0449.0000	251.0449.0000	251.0449.0000		
L	all	251.0449.0000	251.0449.0000	251.0449.0000	251.0449.0000	251.0449.0000	251.0449.0000		
M		251.0449.0000	251.0449.0000	251.0449.0000	251.0449.0000	251.0449.0000			
N		251.0449.0000	251.0449.0000	251.0449.0000	251.0449.0000	251.0449.0000			
P		251.0449.0000	251.0449.0000	251.0549.0000	251.0549.0000	251.0549.0000			
Q		251.0549.0000	251.0549.0000	251.0549.0000	251.0549.0000				
R		251.0549.0000	251.0549.0000	251.1949.0000	251.1949.0000				
T		251.1949.0000	251.1949.0000	251.1949.0000					

## Spare parts – Balanced bellows (Item 15) and bellows conversion kits

Bellows (Item 15)		Material 2.4856 Inconel 625 / 1.4404 316L						
Orifice	Body material	Flange rating class						
		150 x 150	300L x 150	300 x 150	600 x 150	900 x 300	1500 x 300	2500 x 300
		Material-No.						
D	all	400.8379.0421	400.8379.0421	400.8379.0421	400.8379.0400	400.8379.0400	400.8379.0400	400.8379.0400
E		400.8379.0421	400.8379.0421	400.8379.0421	400.8379.0400	400.8379.0400	400.8379.0400	400.8379.0400
F		400.8479.0421	400.8479.0421	400.8479.0421	400.8479.0400	400.8479.0400	400.8479.0400	400.8479.0400
G		400.8579.0421	400.8579.0421	400.8579.0421	400.8579.0400	400.8579.0400	400.8579.0400	400.8579.0400
Orifice	Body material	Flange rating class						
		150 x 150	300L x 150	300 x 150	600 x 150	900 x 150	1500 x 300	
H	all	400.8579.0421	400.8579.0421	400.8779.0400	400.8779.0400	400.8779.0400	400.8779.0400	400.8779.0400
J		400.8879.0400	400.8879.0400	400.8879.0400	400.8879.0400	400.8879.0400	400.8879.0400	400.8879.0400
K		400.8979.0421	400.8979.0421	400.8979.0421	400.8979.0400	400.8979.0400	400.8979.0400	400.8979.0400
Orifice	Body material	Flange rating class						
		150 x 150	300L x 150	300 x 150	600 x 150	900 x 150	1500 x 150	
L	all	400.9079.0400	400.9079.0400	400.9179.0400	400.9179.0400	400.9179.0400	400.9179.0400	400.9179.0400
M		400.9279.0421	400.9279.0421	400.9279.0421	400.9279.0400	400.9279.0400		
N		400.9379.0421	400.9379.0421	400.9379.0421	400.9379.0400	400.9379.0400		
P		400.9479.0400	400.9479.0400	400.9579.0400	400.9579.0400	400.9579.0400		
Q		400.9679.0400	400.9679.0400	400.9679.0400	400.9679.0400			
R		400.9779.0421	400.9779.0421	400.9779.0400	400.9779.0400			
T		400.9879.0400	400.9879.0400	400.9879.0400				

Bellows conversion kits		Material 2.4856 Inconel 625 / 1.4404 316L						
Orifice	Body material	Flange rating class						
		150 x 150	300L x 150	300 x 150	600 x 150	900 x 300	1500 x 300	2500 x 300
		Art.-No.						
D	all	5021.1340	5021.1340	5021.1340	5021.1341	5021.1342	5021.1342	5021.1343
E		5021.1340	5021.1340	5021.1340	5021.1341	5021.1342	5021.1342	5021.1343
F		5021.1344	5021.1344	5021.1344	5021.1345	5021.1346	5021.1346	5021.1346
G		5021.1350	5021.1350	5021.1350	5021.1351	5021.1352	5021.1353	5021.1353
Orifice	Body material	Flange rating class						
		150 x 150	300L x 150	300 x 150	600 x 150	900 x 150	1500 x 300	
H	all	5021.1354	5021.1354	5021.1355	5021.1355	5021.1355	5021.1355	5021.1355
J		5021.1356	5021.1356	5021.1357	5021.1357	5021.1357	5021.1357	5021.1357
K		5021.1360	5021.1360	5021.1360	5021.1361	5021.1362	5021.1362	5021.1362
Orifice	Body material	Flange rating class						
		150 x 150	300L x 150	300 x 150	600 x 150	900 x 150	1500 x 150	
L	all	5021.1363	5021.1363	5021.1364	5021.1364	5021.1364	5021.1364	5021.1364
M		5021.1365	5021.1365	5021.1365	5021.1366	5021.1366		
N		5021.1370	5021.1370	5021.1370	5021.1371	5021.1371		
P		5021.1372	5021.1372	5021.1373	5021.1373	5021.1373		
Q		5021.1374	5021.1374	5021.1374	5021.1374			
R		5021.1375	5021.1375	5021.1376	5021.1376			
T		5021.1377	5021.1377	5021.1377				

A conversion kit contains the following components:

Item	Component	No.	Item	Component	No.
8	Guide	1	60	Gasket	2, 3 depends on valve size
11	Bonnet spacer / Cooling spool	1		Installation instruction LWN 037.05	1
12	Spindle	1			
15	Bellows	1			
55	Stud	4, 8, 12 depends on valve size			

## Spare parts – Ball (Item 57 / Item 61)

Type 526

Ball (Item 57)		Material 316 1.4401						
Orifice	Body material	Flange rating class						
		150 x 150	300L x 150	300 x 150	600 x 150	900 x 300	1500 x 300	2500 x 300
Material-No.								
D	all				Ø 3 mm 510.0604.0000 12 pieces			
E								
F								
G								
Orifice	Body material	Flange rating class						
		150 x 150	300L x 150	300 x 150	600 x 150	900 x 150	1500 x 300	
H	all	Ø 3 mm 510.0604.0000 / 12 pieces			Ø 3 mm 510.0604.0000 15 pieces			
J								
K								
Orifice	Body material	Flange rating class						
		150 x 150	300L x 150	300 x 150	600 x 150	900 x 150	1500 x 150	
L	all				Ø 3 mm 510.0604.0000 15 pieces			
M								
N								
P								
Q								
R								
T								

Ball (Item 61)		Material 316 1.4401						
Orifice	Body material	Flange rating class						
		150 x 150	300L x 150	300 x 150	600 x 150	900 x 300	1500 x 300	2500 x 300
Material-No.								
D	all				Ø 9 mm 510.0204.0000			
E								
F								
G								
Orifice	Body material	Flange rating class						
		150 x 150	300L x 150	300 x 150	600 x 150	900 x 150	1500 x 300	
H	all	Ø 9 mm / 510.0204.0000						
J					Ø 15 mm 510.0404.0000			
K								
Orifice	Body material	Flange rating class						
		150 x 150	300L x 150	300 x 150	600 x 150	900 x 150	1500 x 150	
L	all				Ø 15 mm 510.0404.0000			
M								
N								
P								
Q								
R								
T								

## Spare parts – Gasket Body / bonnet (Item 60), Axial needle bearing (Item 69)

Gasket (Item 60)		Material Graphite / 316, Graphite / 1.4401						
Orifice	Body material	Flange rating class						
		150 x 150	300L x 150	300 x 150	600 x 150	900 x 300	1500 x 300	2500 x 300
		Material-No.						
D	all	500.0807.0000	500.0807.0000	500.0807.0000	500.0807.0000	500.1207.0000	500.1207.0000	500.1207.0000
E		500.0807.0000	500.0807.0000	500.0807.0000	500.0807.0000	500.1207.0000	500.1207.0000	500.1207.0000
F		500.1207.0000	500.1207.0000	500.1207.0000	500.1207.0000	500.1207.0000	500.1207.0000	500.1207.0000
G		500.1207.0000	500.1207.0000	500.1207.0000	500.1207.0000	500.1207.0000	500.1207.0000	500.1607.0000
Orifice	Body material	Flange rating class						
		150 x 150	300L x 150	300 x 150	600 x 150	900 x 150	1500 x 300	
H	all	500.1207.0000	500.1207.0000	500.1607.0000	500.1607.0000	500.1607.0000	500.1607.0000	500.1607.0000
J		500.1607.0000	500.1607.0000	500.1907.0000	500.1907.0000	500.1907.0000	500.1907.0000	500.1907.0000
K		500.1907.0000	500.1907.0000	500.1907.0000	500.1907.0000	Other: 500.2107.0000	500.2107.0000	
	WC6					500.1907.0000		
Orifice	Body material	Flange rating class						
		150 x 150	300L x 150	300 x 150	600 x 150	900 x 150	1500 x 150	
L	all	500.1907.0000	500.1907.0000	500.2107.0000	500.2107.0000	500.2107.0000	500.2107.0000	
M		500.2107.0000	500.2107.0000	500.2107.0000	500.2107.0000	500.2107.0000		
N		500.2107.0000	500.2107.0000	500.2107.0000	500.2107.0000	500.2107.0000		
P		500.2107.0000	500.2107.0000	500.2207.0000	500.2207.0000	500.2207.0000		
Q		500.2207.0000	500.2207.0000	500.2207.0000	500.2207.0000			
R		500.2207.0000	500.2207.0000	500.2807.0000	500.2807.0000			
T		500.2807.0000	500.2807.0000	500.2807.0000				

Axial needle bearing (Item 69)		Material 316 1.4401						
Orifice	Body material	Flange rating class						
		150 x 150	300L x 150	300 x 150	600 x 150	900 x 300	1500 x 300	2500 x 300
		Material-No.						
D	all	250.0749.0000	250.0749.0000	250.0749.0000	250.0749.0000	250.0749.0000	250.0749.0000	250.0749.0000
E		250.0749.0000	250.0749.0000	250.0749.0000	250.0749.0000	250.0749.0000	250.0749.0000	250.0749.0000
F		250.0749.0000	250.0749.0000	250.0749.0000	250.0749.0000	250.0749.0000	250.0749.0000	250.0749.0000
G		250.0749.0000	250.0749.0000	250.0749.0000	250.0749.0000	250.0749.0000	250.0849.0000	250.0849.0000
Orifice	Body material	Flange rating class						
		150 x 150	300L x 150	300 x 150	600 x 150	900 x 150	1500 x 300	
H	all	250.0749.0000	250.0749.0000	250.0849.0000	250.0849.0000	250.0849.0000	250.0849.0000	250.0849.0000
J		250.0849.0000	250.0849.0000	250.0949.0000	250.0949.0000	250.0949.0000	250.0949.0000	250.0949.0000
K		250.0949.0000	250.0949.0000	250.0949.0000	250.0949.0000	250.0949.0000	250.0949.0000	250.0949.0000
Orifice	Body material	Flange rating class						
		150 x 150	300L x 150	300 x 150	600 x 150	900 x 150	1500 x 150	
L	all	250.0949.0000	250.0949.0000	250.0949.0000	250.0949.0000	250.0949.0000	250.0949.0000	
M		250.0949.0000	250.0949.0000	250.0949.0000	250.0949.0000	250.0949.0000		
N		250.0949.0000	250.0949.0000	250.0949.0000	250.0949.0000	250.0949.0000		
P		250.0949.0000	250.0949.0000	250.1049.0000	250.1049.0000	250.1049.0000		
Q		250.1049.0000	250.1049.0000	250.1049.0000	250.1049.0000			
R		250.1049.0000	250.1049.0000	250.1049.0000	250.1049.0000			
T		250.1049.0000	250.1049.0000	250.1049.0000				

## Available Options

For further information refer to  
"Accessories and Options", page 99/01

**Butt-weld connection**  
S05

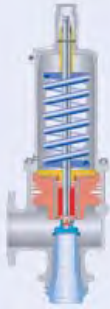

**Heating jacket**

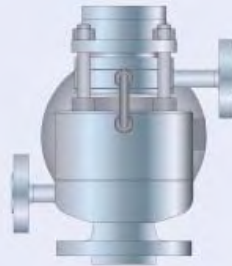

**O-ring disc**

J21: CR "K"  
J22: EPDM "D"  
J23: FKM "L"  
J20: FFKM "C"

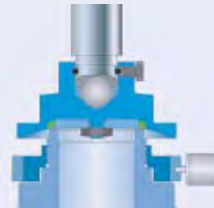

**Disc with inserted sealing plate**

J44+S07: PTFE-FDA "A"  
J48+S07: PCTFE "G"  
J49+S07: SP "T"

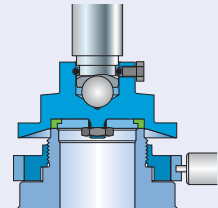

**Open bonnet**  
See Art.-No.



**Balanced bellows**  
J83: Bellows INCONEL  
J78: Bellows 1.4571  
J88: High temperature equipment

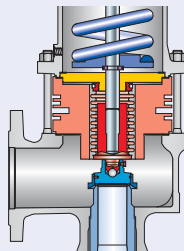

**Conversion kit for balanced bellows**  
See Art.-No. page 01/79

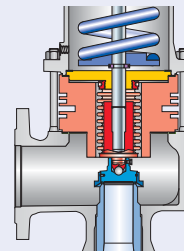

**Screwed cap H2**  
H2

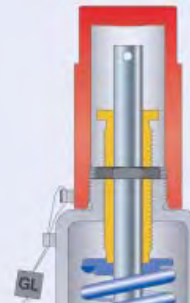

**Plain lever H3**  
H3

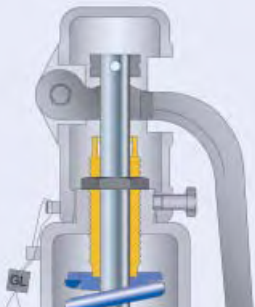

**Packed lever H4**  
H4

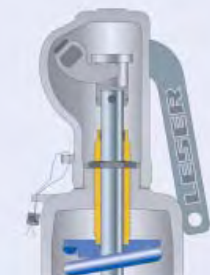

**Bolted cap H1**  
K01

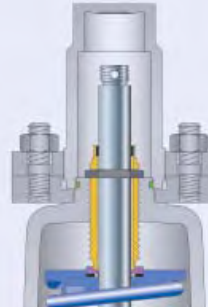

**Bolted lifting device H6**  
K06

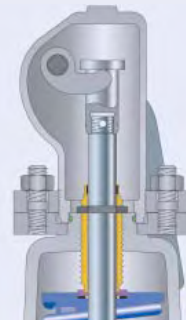

**Lift indicator**  
J39: Adaptor for lift indicator H4  
J93: Lift indicator

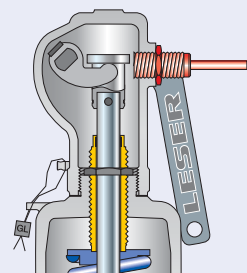

**Test gag**  
J69: H4  
J70: H2

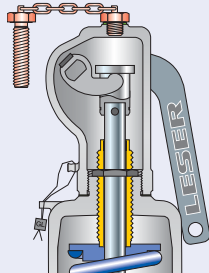

**Bug screen**  
M70

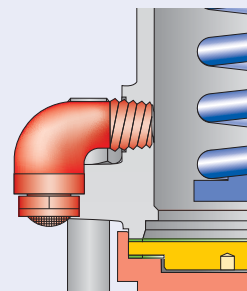

## Approvals

Approvals			
	Orifice	D	E – T
<b>Europe</b>			<b>Coefficient of discharge <math>K_{dr}</math></b>
PED/DIN EN ISO 4126-1	Approval No.	07 202 1111Z0012/2/26	
	S/G	0.45	0.80
	L	0.32	0.58
<b>Germany</b>			<b>Coefficient of discharge <math>\alpha_w</math></b>
PED/AD 2000-Merkblatt A2	Approval No.	TÜV SV 1082	
	S/G	0.45	0.80
	L	0.32	0.58
<b>United States</b>			<b>Coefficient of discharge K</b>
ASME Sec. VIII Div. 1	Approval No.	M37246	M37224
	S/G	Rated slope acc. to ASME VIII. Div. 1 UG-131 (d) (2) G: 1.99 SCFM/psia S: 5.59 lb/hr/psia	0.801
	Approval No.	M37257	M37235
	L	Rated slope acc. to ASME VIII. Div. 1 UG-131 (d) (2) 3.11 GPM/ $\sqrt{\text{psid}}$	0.579
<b>Canada</b>			<b>Coefficient of discharge K</b>
Canada: CRN	Approval No.	For current approval no. see <a href="http://www.leser.com">www.leser.com</a>	
	S/G	Rated slope acc. to ASME VIII. Div. 1 UG-131 (d) (2) G: 1.99 SCFM/psia S: 5.59 lb/hr/psia	0.801
	L	Rated slope acc. to ASME VIII. Div. 1 UG-131 (d) (2) 3.11 GPM/ $\sqrt{\text{psid}}$	0.579
<b>China</b>			<b>Coefficient of discharge <math>\alpha_w</math></b>
AQSIQ	Approval No.	For current approval no. see <a href="http://www.leser.com">www.leser.com</a>	
	S/G	0.45	0.80
	L	0.32	0.58
<b>Russia</b>			<b>Coefficient of discharge <math>\alpha_w</math></b>
GOST R / RTN	Approval No.	PPC 00-18458	
	S/G	0.45	0.80
	L	0.32	0.58
<b>Kazakhstan</b>			<b>Coefficient of discharge <math>\alpha_w</math></b>
GOST-K	Approval No.	For current approval no. see <a href="http://www.leser.com">www.leser.com</a>	
	S/G	0.45	0.80
	L	0.32	0.58
<b>Belarus</b>			<b>Coefficient of discharge <math>\alpha_w</math></b>
GOSPROMNAZADOR	Approval No.	For current approval no. see <a href="http://www.leser.com">www.leser.com</a>	
	S/G	0.45	0.80
	L	0.32	0.58
<b>Classification societies</b>			<b>Homepage</b>
Bureau Veritas	BV	<a href="http://www.bureauveritas.com">www.bureauveritas.com</a>	
Det Norske Veritas	DNV	<a href="http://www.dnv.com">www.dnv.com</a>	
Germanischer Lloyd	GL	<a href="http://www.gl-group.com">www.gl-group.com</a>	
Lloyd' s register EMEA	LREMEA	<a href="http://www.lr.org">www.lr.org</a>	
Registro Italiano Navale	RINA	<a href="http://www.rina.org">www.rina.org</a>	
U.S. Coast Guard	U.S.C.G	<a href="http://www.uscg.org">www.uscg.org</a>	
			The valid certification number is changed with every renewal.
			For a sample certificate including the valid certification number see <a href="http://www.leser.com">www.leser.com</a>



## Capacities – Steam

Capacities for saturated steam according to AD 2000-Merkblatt A2, based on set pressure plus 10 % overpressure.  
 Capacities at 1 bar (14.5 psig) and below are based on 0.1 bar (1.45 psig) overpressure.

Metric Units	AD 2000-Merkblatt A2 [kg/h]													
Orifice	D	E	F	G	H	J	K	L	M	N	P	Q	R	T
Act. Orifice dia. $d_0$ [mm]	14.0	14.0	18.0	22.5	28.3	36.0	43.0	53.5	60.3	66.0	80.0	105.5	126.0	161.5
Act. Orifice area $A_0$ [mm <sup>2</sup> ]	154	154	254	398	629	1018	1452	2248	2856	3421	5027	8742	12568	20485
LEO <sub>S/G</sub> <sup>*)</sup> [inch <sup>2</sup> ]	0.111	0.196	0.324	0.506	0.801	1.296	1.849	2.863	3.637	4.357	6.401	11.132	16.004	26.085
Set pressure [bar]	Capacities [kg/h]													
0.2	19	54	89	139	221	357	509	788	1001	1199	1762	3065	4372	7182
0.5	42	90	149	232	367	595	848	1313	1668	1999	2937	5107	7285	11968
1	71	134	221	345	546	883	1260	1951	2479	2969	4363	7587	10823	17780
2	120	217	359	561	888	1437	2050	3174	4032	4830	7096	12341	17603	28920
3	166	296	489	764	1209	1956	2791	4320	5488	6575	9660	16799	23962	39366
4	208	369	610	953	1507	2439	3480	5387	6843	8198	12045	20948	29879	49088
5	248	442	730	1141	1805	2920	4166	6449	8193	9815	14420	25078	35770	58766
6	289	514	850	1328	2101	3399	4850	7508	9537	11426	16787	29194	41642	68413
7	329	585	967	1511	2390	3867	5517	8540	10849	12997	19096	33210	47371	77824
8	369	657	1086	1697	2684	4343	6196	9592	12185	14597	21447	37299	53202	87404
9	410	729	1205	1882	2978	4818	6874	10642	13519	16195	23795	41382	59026	96973
10	450	801	1323	2068	3271	5293	7552	11691	14852	17792	26141	45461	64845	106532
12	531	872	1561	2439	3858	6243	8907	13788	17515	20983	30829	53615	76475	125639
14	610	944	1793	2802	4432	7172	10233	15841	20123	24107	35419	61598	87862	144347
16	691	1085	2030	3172	5018	8120	11584	17933	22781	27291	40097	69733	99467	163411
18	771	1228	2267	3542	5604	9068	12938	20027	25442	30479	44781	77879	111085	182499
20	852	1371	2505	3913	6191	10018	14293	22125	28107	33672	49473	86038	122723	201618
22	931	1515	2735	4273	6760	10940	15608	24161	30693	36770	54024	93952		
24	1012	1654	2973	4645	7349	11891	16965	26262	33363	39968	58723	102125		
26	1093	1798	3211	5018	7938	12845	18327	28369	36039	43175	63434	110318		
28	1174	1943	3451	5392	8529	13802	19692	30483	38724	46391	68159	118536		
30	1256	2087	3691	5766	9122	14762	21061	32602	41417	49617	72899	126779		
32	1338	2233	3931	6143	9718	15725	22435	34729	44118	52853	77654	135048		
34	1416	2378	4161	6502	10286	16644	23747	36760	46698	55944	82195	142945		
36	1498	2517	4403	6879	10883	17611	25126	38895	49411	59194	86970	151250		
38	1581	2663	4646	7259	11483	18582	26511	41039	52134	62457	91764	159586		
40	1664	2810	4889	7639	12085	19557	27901	43191	54868	65732	96576	167955		
50	2083	2958	6123	9567	15134	24490	34940	54088	68711	82315	120941			
60	2506	3704	7364	11506	18203	29456	42025	65055	82643	99006	145463			
70	2945	4455	8656	13525	21396	34624	49398	76467	97141					
80	3388	5236	9957	15558	24613	39828	56823	87962						
90	3854	6023	11326	17697	27997	45305	64636	100056						
100	4324	6852	12708	19856	31413	50832	72522	112264						
120	5349	7688	15720	24562	38858	62880	89710							
140	6505	9510	19117	29870	47255	76468	109096							
160	7842	11565	23045	36008	56965	92180								
180	9527	13941	27996	43744	69203	111985								
200	11793	16936	34657	54151										

<sup>\*)</sup> LEO<sub>S/G</sub> = LESER Effective Orifice steam/gas please refer to page 00/07. How to use capacity-sheets refer to page 00/05

## Capacities – Steam

Capacities for saturated steam according to ASME Section VIII (UV), based on set pressure plus 10% overpressure.  
 Capacities at 2.07 bar (30 psig) and below are based on 0.207 bar (3 psig) overpressure.

US Units	ASME Section VIII [lb/h]													
Orifice	D	E	F	G	H	J	K	L	M	N	P	Q	R	T
Act. Orifice dia. $d_0$ [inch]	0.551	0.551	0.709	0.886	1.11	1.42	1.69	2.11	2.37	2.6	3.15	4.15	4.98	6.36
Act. Orifice area $A_0$ [inch <sup>2</sup> ]	0.239	0.239	0.394	0.616	0.975	1.58	2.25	3.48	4.43	5.30	7.79	13.55	19.48	31.75
LEO <sub>S/G</sub> * [inch <sup>2</sup> ]	0.111	0.196	0.324	0.506	0.801	1.296	1.849	2.863	3.637	4.357	6.401	11.132	16.004	26.085
Set pressure [psig]	Capacities [lb/h]													
15	183	321	531	830	1313	1981	3032	4694	5963	7144	10496	18253	26036	42774
20	211	371	613	957	1515	2415	3497	5413	6876	8237	12103	21048	30022	49323
30	266	469	775	1212	1917	3239	4425	6850	8702	10425	15317	26637	37995	62421
40	328	577	954	1491	2359	4001	5446	8431	10711	12831	18852	32786	46765	76829
50	389	686	1133	1771	2802	4788	6468	10012	12719	15237	22387	38934	55535	91237
60	451	794	1312	2051	3244	5520	7489	11593	14728	17644	25923	45082	64305	105644
70	512	902	1491	2330	3686	6251	8511	13174	16736	20050	29458	51231	73075	120052
80	574	1010	1670	2610	4129	6980	9532	14756	18745	22456	32994	57379	81845	134460
90	635	1119	1849	2889	4571	7686	10553	16337	20753	24862	36529	63527	90614	148868
100	697	1227	2028	3169	5014	8411	11575	17918	22762	27269	40064	69676	99384	163276
120	820	1444	2386	3728	5898	9857	13618	21080	26779	32081	47135	81973	116924	192092
140	943	1660	2744	4288	6783	11301	15660	24242	30796	36894	54206	94269	134464	220907
160	1066	1877	3102	4847	7668	12744	17703	27404	34814	41706	61276	106566	152004	249723
180	1189	2093	3460	5406	8553	14147	19746	30567	38831	46519	68347	118863	169544	278539
200	1312	2310	3818	5966	9438	15585	21789	33729	42848	51331	75418	131159	187084	307355
220	1435	2526	4176	6525	10323	17024	23831	36891	46865	56144	82489	143456	204623	336170
240	1558	2743	4534	7084	11207	18464	25874	40053	50882	60956	89559	155753	222163	364986
260	1681	2959	4892	7644	12092	19905	27917	43216	54899	65769	96630	168050	239703	393802
280	1804	3176	5250	8203	12977	21347	29960	46378	58917	70581	103701	180346	257243	422618
300	1927	3392	5608	8762	13862	22792	32003	49540	62934	75394	110772	192643	274783	451433
320	2050	3609	5966	9322	14747	24172	34045	52702	66951	80206	117842	204940		
340	2173	3825	6324	9881	15632	25617	36088	55864	70968	85019	124913	217237		
360	2296	4042	6682	10440	16516	27065	38131	59027	74985	89832	131984	229533		
380	2419	4259	7040	10999	17401	28515	40174	62189	79002	94644	139055	241830		
400	2542	4475	7398	11559	18286	29969	42217	65351	83020	99457	146125	254127		
420	2665	4692	7756	12118	19171	31425	44259	68513	87037	104269	153196	266424		
440	2788	4908	8114	12677	20056	32884	46302	71676	91054	109082	160267	278720		
460	2911	5125	8471	13237	20940	34347	48345	74838	95071	113894	167338	291017		
480	3034	5341	8829	13796	21825	35814	50388	78000	99088	118707	174408	303314		
500	3157	5558	9187	14355	22710	37179	52430	81162	103105	123519	181479	315610		
600	3772	6641	10977	17152	27134	44566	62644	96973	123191	147582	216833	377094		
700	4387	7723	12767	19948	31558	52057	72858	112784	143277	171644	252186			
800	5002	8806	14557	22745	35983	59498	83072	128596	163363	195707	287540			
900	5617	9889	16347	25541	40407	67216	93286	144407	183449	219770	322894			
1000	6232	10971	18136	28338	44831	75076	103500	160218	203534	243832	358248			
1100	6847	12054	19926	31134	49255	82854	113714	176029	223620					
1200	7462	13137	21716	33931	53679	91018	123928	191840						
1300	8077	14219	23506	36728	58103	99369	134142	207651						
1400	8680	15281	25260	39469	62439	107926	144153	223148						
1500	9352	16463	27215	42523	67272	116375	155310	240420						
2000	12930	22763	37628	58794	93013	164706	214738							
2500	17111	30123	49795	77805	123088	227979								

\*) LEO<sub>S/G</sub> = LESER Effective Orifice steam/gas please refer to page 00/07. How to use capacity-sheets refer to page 00/05

## Capacities – Air

Capacities for air according to AD 2000-Merkblatt A2, based on set pressure plus 10 % overpressure at 0 °C and 1013 mbar. Capacities at 1 bar (14.5 psig) and below are based on 0.1 bar (1.45 psig) overpressure.

Metric Units		AD 2000-Merkblatt A2 [m <sup>3</sup> /h]													
Orifice	D	E	F	G	H	J	K	L	M	N	P	Q	R	T	
Act. Orifice dia. d <sub>0</sub> [mm]	14.0	14.0	18.0	22.5	28.3	36.0	43.0	53.5	60.3	66.0	80.0	105.5	126.0	161.5	
Act. Orifice area A <sub>0</sub> [mm <sup>2</sup> ]	154	154	254	398	629	1018	1452	2248	2856	3421	5027	8742	12568	20485	
LEO <sub>S/G</sub> <sup>*)</sup> [inch <sup>2</sup> ]	0.111	0.196	0.324	0.506	0.801	1.296	1.849	2.863	3.637	4.357	6.401	11.132	16.004	26.085	
Set pressure [bar]	Capacities [m <sup>3</sup> /h]														
0.2	22	63	103	161	255	413	590	913	1159	1389	2041	3549	5062	8317	
0.5	50	106	175	273	432	699	997	1543	1960	2348	3450	5999	8557	14058	
1	84	159	263	411	651	1053	1502	2326	2954	3539	5200	9044	12900	21192	
2	145	262	434	678	1072	1735	2476	3833	4869	5833	8570	14905	21260	34927	
3	203	361	597	934	1477	2390	3410	5278	6705	8033	11802	20525	29277	48098	
4	255	454	750	1172	1854	3000	4280	6625	8417	10083	14814	25764	36749	60374	
5	307	546	902	1410	2231	3610	5150	7973	10128	12133	17827	31002	44221	72650	
6	359	638	1055	1648	2608	4220	6020	9320	11839	14183	20839	36241	51693	84925	
7	411	730	1207	1887	2985	4830	6891	10667	13551	16234	23851	41479	59165	97201	
8	463	823	1360	2125	3362	5440	7761	12014	15262	18284	26863	46718	66637	109477	
9	515	915	1512	2363	3739	6050	8631	13361	16973	20334	29875	51956	74109	121752	
10	567	1007	1665	2601	4116	6660	9501	14708	18685	22384	32887	57195	81581	134028	
12	670	1099	1970	3078	4869	7880	11242	17402	22107	26484	38912	67672	96526	158579	
14	774	1192	2275	3555	5623	9100	12982	20097	25530	30585	44936	78149	111470	183131	
16	878	1376	2580	4031	6377	10320	14723	22791	28953	34685	50961	88626	126414	207682	
18	982	1561	2885	4508	7131	11539	16463	25485	32375	38785	56985	99102	141358	232233	
20	1085	1745	3190	4984	7885	12759	18204	28179	35798	42886	63009	109579	156302	256785	
22	1189	1930	3495	5461	8639	13979	19944	30874	39221	46986	69034	120056			
24	1293	2114	3800	5937	9393	15199	21685	33568	42643	51086	75058	130533			
26	1397	2299	4105	6414	10147	16419	23425	36262	46066	55187	81082	141010			
28	1501	2483	4410	6890	10900	17639	25166	38956	49489	59287	87107	151487			
30	1604	2668	4715	7367	11654	18859	26906	41651	52911	63387	93131	161964			
32	1708	2852	5020	7843	12408	20079	28647	44345	56334	67488	99155	172441			
34	1812	3037	5325	8320	13162	21299	30387	47039	59757	71588	105180	182918			
36	1916	3221	5630	8796	13916	22519	32128	49733	63179	75688	111204	193395			
38	2019	3406	5935	9273	14670	23739	33868	52428	66602	79789	117228	203872			
40	2123	3590	6240	9749	15424	24959	35608	55122	70025	83889	123253	214349			
50	2642	3775	7765	12132	19193	31058	44311	68593	87138	104390	153374				
60	3161	4697	9289	14515	22963	37158	53013	82064	104251	124892	183496				
70	3680	5620	10814	16898	26732	43258	61716	95536	121365						
80	4199	6542	12339	19280	30501	49357	70418	109007							
90	4718	7465	13864	21663	34271	55457	79120	122478							
100	5237	8387	15389	24046	38040	61557	87823	135949							
120	6274	9309	18439	28811	45579	73756	105227								
140	7312	11154	21489	33576	53118	85955	122632								
160	8350	12999	24539	38342	60657	98155									
180	9388	14844	27588	43107	68195	110354									
200	10426	16689	30638	47872											
220	11463	18534	33688	52638											
240	12501	20379	36738	57403											
260	13539	22224	39788												
280	14577	24069	42838												
300	15614	25914	45887												
350	18209	27759													
400	20803	32371													

<sup>\*)</sup> LEO<sub>S/G</sub> = LESER Effective Orifice steam/gas please refer to page 00/07. How to use capacity-sheets refer to page 00/05

## Capacities – Air

Capacities for air according to ASME Section VIII (UV), based on set pressure plus 10 % overpressure at 16 °C (60 °F).  
 Capacities at 2.07 bar (30 psig) and below are based on 0.207 bar(3 psig) overpressure.

US Units	ASME Section VIII [S.C.F.M.]													
Orifice	D	E	F	G	H	J	K	L	M	N	P	Q	R	T
Act. Orifice dia. d <sub>0</sub> [inch]	0.551	0.551	0.709	0.886	1.11	1.42	1.69	2.11	2.37	2.6	3.15	4.15	4.96	6.36
Act. Orifice area A <sub>0</sub> [inch <sup>2</sup> ]	0.239	0.239	0.394	0.616	0.975	1.58	2.25	3.48	4.43	5.30	7.79	13.55	19.48	31.75
LEO <sub>S/G</sub> <sup>*)</sup> [inch <sup>2</sup> ]	0.111	0.196	0.324	0.506	0.801	1.296	1.849	2.863	3.637	4.357	6.401	11.132	16.004	26.085
Set pressure [psig]	Capacities [S.C.F.M.]													
15	65.0	115	189	296	468	757	1080	1672	2124	2545	3739	6502	9275	15237
20	75.0	132	218	341	540	873	1246	1928	2449	2934	4311	7498	10695	17570
30	95.0	167	276	431	683	1105	1576	2440	3100	3714	5456	9489	13535	22236
40	117	206	340	531	840	1360	1940	3003	3815	4571	6715	11679	16659	27368
50	139	245	403	631	998	1615	2304	3566	4530	5428	7975	13869	19783	32501
60	161	283	467	730	1156	1870	2668	4129	5246	6285	9234	16060	22907	37633
70	183	322	531	830	1313	2125	3032	4692	5961	7142	10493	18250	26031	42765
80	205	361	594	929	1471	2380	3396	5256	6677	8000	11753	20440	29155	47898
90	227	399	658	1029	1628	2635	3759	5819	7392	8857	13012	22630	32279	53030
100	249	438	722	1128	1786	2891	4123	6382	8107	9714	14271	24821	35403	58163
120	293	515	849	1328	2101	3401	4851	7508	9538	11428	16790	29201	41651	68428
140	336	592	976	1527	2416	3911	5579	8635	10969	13143	19309	33582	47899	78693
160	380	670	1104	1726	2732	4421	6306	9761	12400	14857	21828	37962	54147	88957
180	424	747	1231	1925	3047	4931	7034	10887	13831	16571	24346	42343	60395	99222
200	468	824	1359	2124	3362	5441	7762	12014	15262	18286	26865	46723	66643	109487
220	512	901	1486	2323	3677	5951	8490	13140	16693	20000	29384	51104	72891	119752
240	556	979	1613	2522	3992	6462	9217	14266	18123	21715	31902	55484	79139	130017
260	600	1056	1741	2722	4308	6972	9945	15392	19554	23429	34421	59864	85388	140282
280	644	1133	1868	2921	4623	7482	10673	16519	20985	25143	36940	64245	91636	150547
300	688	1210	1995	3120	4938	7992	11400	17645	22416	26858	39458	68625	97884	160811
320	731	1288	2123	3319	5253	8502	12128	18771	23847	28572	41977	73006		
340	775	1365	2250	3518	5568	9012	12856	19898	25278	30286	44496	77386		
360	819	1442	2378	3717	5884	9522	13584	21024	26708	32001	47014	81767		
380	863	1519	2505	3916	6199	10033	14311	22150	28139	33715	49533	86147		
400	907	1597	2632	4116	6514	10543	15039	23277	29570	35429	52052	90528		
420	951	1674	2760	4315	6829	11053	15767	24403	31001	37144	54571	94908		
440	995	1751	2887	4514	7144	11563	16494	25529	32432	38858	57089	99289		
460	1039	1829	3014	4713	7460	12073	17222	26656	33863	40573	59608	103669		
480	1083	1906	3142	4912	7775	12583	17950	27782	35294	42287	62127	108050		
500	1126	1983	3269	5111	8090	13093	18678	28908	36724	44001	64645	112430		
600	1346	2369	3906	6107	9666	15644	22316	34540	43879	52573	77239	134333		
700	1565	2756	4543	7103	11242	18195	25955	40171	51033	61145	89832			
800	1785	3142	5180	8098	12818	20745	29593	45803	58187	69717	102426			
900	2004	3528	5817	9094	14394	23296	33232	51435	65341	78289	115019			
1000	2224	3915	6454	10090	15970	25847	36870	57066	72496	86860	127613			
1100	2443	4301	7090	11085	17546	28398	40509	62698	79650					
1200	2663	4687	7727	12081	19122	30948	44147	68329						
1300	2882	5074	8364	13077	20698	33499	47786	73961						
1400	3101	5460	9001	14073	22274	36050	51424	79592						
1500	3321	5846	9638	15068	23850	38600	55063	85224						
2000	4418	7778	12822	20047	31730	51354	73256	113382						
2500	5515	9710	16007	25025	39610	64107								
3000	6613	11641	19191	30004										
3500	7710	13573	22375	34983										
4000	8807	15504	25560											
4500	9904	17436	28744											
5000	11002	19368	31928											
5500	12099	21299												
6000	13196	23231												

<sup>\*)</sup> LEO<sub>S/G</sub> = LESER Effective Orifice steam/gas please refer to page 00/07. How to use capacity-sheets refer to page 00/05

## Capacities – Water

Capacities for water according to AD 2000-Merkblatt A2, based on set pressure plus 10 % overpressure at 20 °C (68 °F).  
Capacities at 1 bar (14.5 psig) and below are based on 0.1 bar (1.45 psig) overpressure.

Metric Units		AD 2000-Merkblatt A2 [10 <sup>3</sup> kg/h]													
Orifice	D	E	F	G	H	J	K	L	M	N	P	Q	R	T	
Act. Orifice dia. d <sub>0</sub> [mm]	14.0	14.0	18.0	22.5	28.3	36.0	43.0	53.5	60.3	66.0	80.0	105.5	126.0	161.5	
Act. Orifice area A <sub>0</sub> [mm <sup>2</sup> ]	154	154	254	398	629	1018	1452	2248	2856	3421	5027	8742	12568	20485	
LEO <sub>L</sub> <sup>*)</sup> [inch <sup>2</sup> ]	0.126	0.213	0.351	0.549	0.868	1.405	2.005	3.104	3.943	4.724	6.940	12.070	17.353	28.283	
Set pressure [bar]	Capacities [10 <sup>3</sup> kg/h]														
0.2	1.37	2.49	4.11	6.42	10.2	16.4	23.5	36.3	46.1	55.3	81.2	141	201	331	
0.5	1.94	3.52	5.81	9.09	14.4	23.3	33.2	51.4	65.3	78.2	115	200	285	468	
1	2.63	4.76	7.87	12.3	19.5	31.5	44.9	69.6	88.4	106	156	270	386	634	
2	3.72	6.74	11.1	17.4	27.5	44.5	63.5	98.4	125	150	220	383	546	896	
3	4.55	8.25	13.6	21.3	33.7	54.5	77.8	120	153	183	269	468	668	1098	
4	5.26	9.53	15.7	24.6	38.9	63	89.9	139	177	212	311	541	772	1268	
5	5.88	10.7	17.6	27.5	43.5	70.4	100	156	198	237	348	605	863	1417	
6	6.44	11.7	19.3	30.1	47.7	77.1	110	170	216	259	381	663	945	1553	
7	6.95	12.6	20.8	32.5	51.5	83.3	119	184	234	280	411	716	1021	1677	
8	7.43	13.5	22.3	34.8	55.0	89.1	127	197	250	299	440	765	1091	1793	
9	7.88	14.3	23.6	36.9	58.4	94.5	135	209	265	318	467	811	1157	1901	
10	8.31	15.1	24.9	38.9	61.5	99.6	142	220	279	335	492	855	1220	2004	
12	9.10	15.8	27.3	42.6	67.4	109	156	241	306	367	539	937	1336	2196	
14	9.83	16.5	29.5	46.0	72.8	118	168	260	331	396	582	1012	1444	2372	
16	10.5	17.8	31.5	49.2	77.8	126	180	278	353	423	622	1082	1543	2535	
18	11.1	19.1	33.4	52.2	82.6	134	191	295	375	449	660	1148	1637	2689	
20	11.8	20.2	35.2	55.0	87.0	141	201	311	395	473	696	1210	1725	2835	
22	12.3	21.3	36.9	57.7	91.3	148	211	326	414	496	729	1269			
24	12.9	22.3	38.6	60.3	95.3	154	220	341	433	519	762	1325			
26	13.4	23.3	40.1	62.7	99.2	161	229	355	451	540	793	1379			
28	13.9	24.3	41.7	65.1	103	167	238	368	468	560	823	1431			
30	14.4	25.2	43.1	67.4	107	172	246	381	484	580	852	1481			
32	14.9	26.1	44.5	69.6	110	178	254	393	500	599	880	1530			
34	15.3	26.9	45.9	71.7	113	184	262	406	515	617	907	1577			
36	15.8	27.8	47.2	73.8	117	189	270	417	530	635	933	1623			
38	16.2	28.6	48.5	75.8	120	194	277	429	545	653	959	1667			
40	16.6	29.4	49.8	77.8	123	199	284	440	559	669	984	1711			
50	18.6	30.1	55.7	87.0	138	223	318	492	625	748	1100				
60	20.4	33.7	61.0	95.3	151	244	348	539	684	820	1205				
70	22.0	36.9	65.9	103	163	263	376	582	739						
80	23.5	39.8	70.4	110	174	282	402	622							
90	24.9	42.6	74.7	117	185	299	426	660							
100	26.3	45.2	78.7	123	195	315	449	696							
120	28.8	47.6	86.2	135	213	345	492								
140	31.1	52.2	93.2	146	230	373	532								
160	33.2	56.4	99.6	156	246	398									
180	35.3	60.2	106	165	261	423									
200	37.2	63.9	111	174											
220	39.0	67.4	117	182											
240	40.7	70.6	122	191											
260	42.4	73.8	127												
280	44.0	76.8	132												
300	45.5	79.7	136												
350	49.2	82.5													
400	52.6	89.1													

<sup>\*)</sup> LEO<sub>L</sub> = LESER Effective Orifice liquids please refer to page 00/08. How to use capacity-sheets refer to page 00/05

## Capacities – Water

Capacities for water according to ASME Section VIII (UV), based on set pressure plus 10 % overpressure at 21 °C (70 °F).  
 Capacities at 2.07 bar (30 psig) and below are based on 0.207 bar (3 psig) overpressure.

US Units	ASME Section VIII [US-G.P.M.]													
Orifice	D	E	F	G	H	J	K	L	M	N	P	Q	R	T
Act. Orifice dia. $d_0$ [inch]	0.551	0.551	0.709	0.886	1.11	1.42	1.69	2.11	2.37	2.6	3.15	4.15	4.96	6.36
Act. Orifice area $A_0$ [inch <sup>2</sup> ]	0.239	0.239	0.394	0.616	0.975	1.58	2.25	3.48	4.43	5.30	7.79	13.55	19.48	31.75
LEO <sub>L</sub> <sup>*)</sup> [inch <sup>2</sup> ]	0.126	0.213	0.351	0.549	0.868	1.405	2.005	3.104	3.943	4.724	6.940	12.070	17.353	28.283
Set pressure [psig]	Capacities [US-G.P.M.]													
15	13.2	22.3	36.7	57.4	90.9	147	210	325	413	494	726	1263	1801	2960
20	14.9	25.2	41.5	64.9	103	166	237	367	466	559	821	1428	2036	3346
30	17.9	30.2	49.7	77.7	123	199	284	440	559	669	983	1710	2439	4007
40	20.6	34.8	57.4	89.8	142	230	328	508	645	773	1135	1975	2817	4627
50	23.1	38.9	64.2	100	159	257	367	568	721	864	1269	2208	3149	5173
60	25.3	42.7	70.3	110	174	282	402	622	790	947	1391	2418	3450	5667
70	27.3	46.1	76.0	119	188	304	434	672	853	1022	1502	2612	3726	6121
80	29.2	49.3	81.2	127	201	325	464	718	912	1093	1606	2793	3983	6544
90	31.0	52.2	86.1	135	213	345	492	762	968	1159	1703	2962	4225	6941
100	32.6	55.1	90.8	142	225	364	519	803	1020	1222	1795	3122	4453	7316
120	35.7	60.3	99.5	155	246	398	568	879	1117	1339	1967	3420	4878	8015
140	38.6	65.2	107	168	266	430	614	950	1207	1446	2124	3694	5269	8657
160	41.3	69.7	115	180	284	460	656	1015	1290	1546	2271	3949	5633	9255
180	43.8	73.9	122	190	301	488	696	1077	1368	1639	2409	4189	5975	9816
200	46.1	77.9	128	201	318	514	734	1135	1442	1728	2539	4416	6298	10347
220	48.4	81.7	135	211	333	539	769	1191	1513	1812	2663	4631	6605	10852
240	50.5	85.3	141	220	348	563	804	1244	1580	1893	2781	4837	6899	11335
260	52.6	88.8	146	229	362	586	836	1294	1644	1970	2895	5034	7181	11797
280	54.6	92.2	152	238	376	608	868	1343	1707	2045	3004	5224	7452	12243
300	56.5	95.4	157	246	389	630	898	1390	1766	2116	3109	5408	7713	12672
320	58.4	98.5	162	254	402	650	928	1436	1824	2186	3211	5585		
340	60.2	102	167	262	414	670	956	1480	1881	2253	3310	5757		
360	61.9	104	172	269	426	690	984	1523	1935	2318	3406	5924		
380	63.6	107	177	277	438	709	1011	1565	1988	2382	3500	6086		
400	65.2	110	182	284	449	727	1037	1606	2040	2444	3590	6244		
420	66.9	113	186	291	460	745	1063	1645	2090	2504	3679	6399		
440	68.4	116	190	298	471	763	1088	1684	2139	2563	3766	6549		
460	70.0	118	195	304	482	780	1112	1722	2187	2621	3850	6696		
480	71.5	121	199	311	492	797	1136	1759	2234	2677	3933	6840		
500	72.9	123	203	317	502	813	1160	1795	2280	2732	4014	6982		
600	79.9	135	222	348	550	891	1271	1966	2498	2993	4397	7648		
700	86.3	146	240	376	594	962	1372	2124	2698	3233	4750			
800	92.3	156	257	401	635	1028	1467	2271	2885	3456	5078			
900	97.9	165	272	426	674	1091	1556	2408	3060	3666	5386			
1000	103	174	287	449	710	1150	1640	2539	3225	3864	5677			
1100	108	183	301	471	745	1206	1720	2663	3382					
1200	113	191	314	492	778	1260	1797	2781						
1300	118	199	327	512	810	1311	1870	2895						
1400	122	206	340	531	841	1360	1941	3004						
1500	126	213	352	550	870	1408	2009	3109						
2000	146	246	406	635	1005	1626	2320	3590						
2500	163	275	454	710	1123	1818								
3000	179	302	497	777										
3500	193	326	537	840										
4000	206	348	574											
4500	219	369	609											
5000	231	389	642											
5500	242	408												
6000	253	427												

<sup>\*)</sup> LEO<sub>L</sub> = LESER Effective Orifice liquids please refer to page 00/08. How to use capacity-sheets refer to page 00/05



## Determination of coefficient of discharge in case of lift restriction or back pressure

Type 526

- $h$  = Lift [mm]
- $d_0$  = Flow diameter [mm] of selected safety valve, refer to table article numbers
- $h/d_0$  = Ratio of lift / flow diameter
- $p_{a0}$  = Back pressure [bar<sub>a</sub>]
- $p_0$  = Set pressure [bar<sub>a</sub>]
- $p_{a0}/p_0$  = Ratio of back pressure / set pressure
- $K_{dr}$  = Coefficient of discharge acc. to DIN EN ISO 4126-1
- $\alpha_w$  = Coefficient of discharge acc. to AD 2000-Merkblatt A2
- $K_b$  = Back pressure correction factor acc. to API 520 topic 3.3

Diagram for evaluation of ratio of lift / flow diameter ( $h/d_0$ ) in reference to the coefficient of discharge ( $K_{dr}/\alpha_w$ )

Note: Lift restriction not approved for ASME-applications.

### Steam and Gases

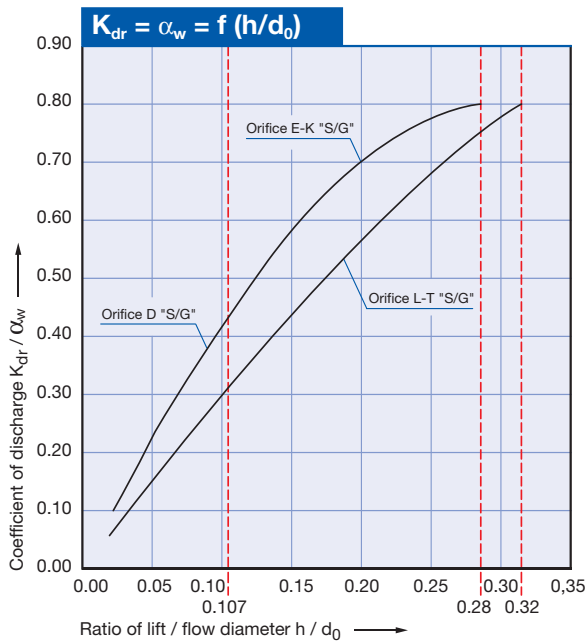

### Liquids

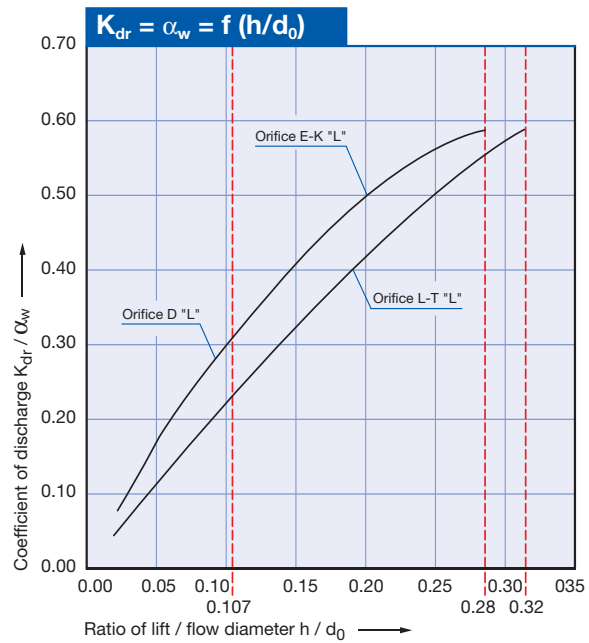
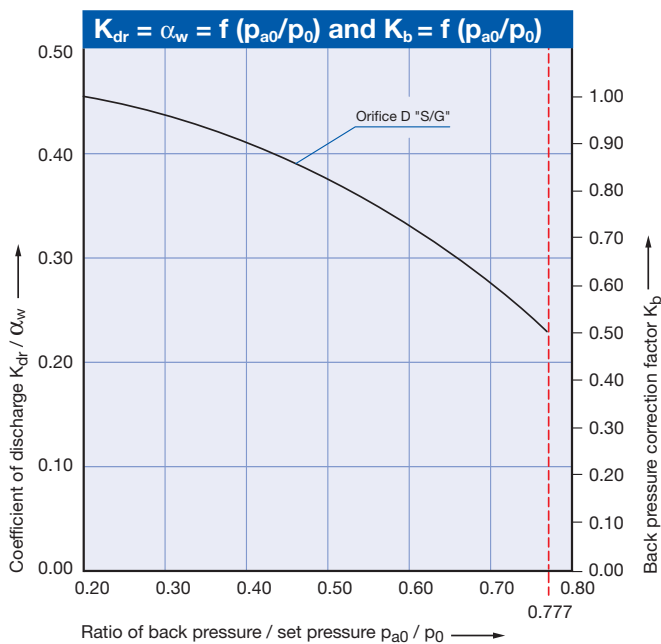
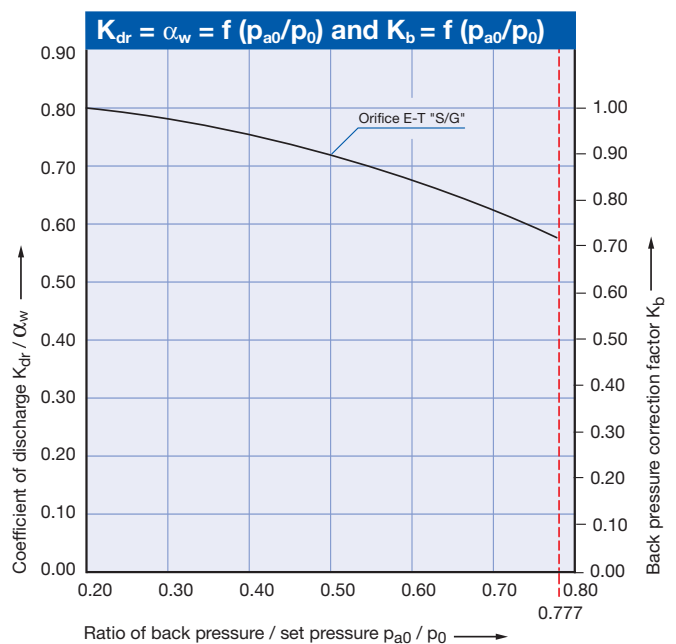

Diagram for evaluation of coefficient of discharge ( $K_{dr}/\alpha_w$ ) or  $K_b$  in reference to the ratio of back pressure / set pressure ( $p_{a0}/p_0$ )

### Orifice D



### Orifice E - T



How to use please refer to page 00/08.

# Accessories and Options

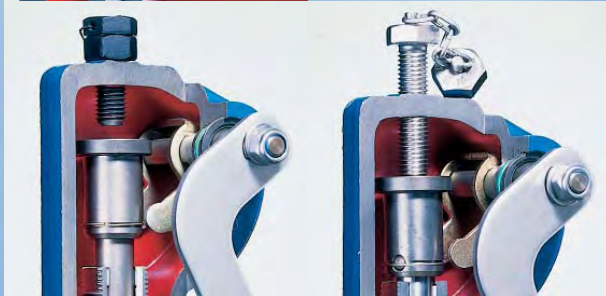
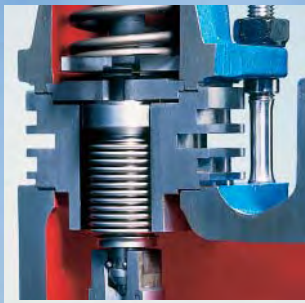

## Contents

## Chapter/Page

Caps and levers	99/02
Caps and levers – bolted	99/04
Metal seat	99/06
Soft seal disc	99/08
Soft seal selection	99/10
Balanced bellows, Bug screen	99/12
High temperature equipment	99/15
INCONEL X-750 spring	99/16
O-ring damper	99/16
Lift indicator	99/17
Heating jacket	99/18



## Caps and levers – Subassembly item 40

### Cap H2

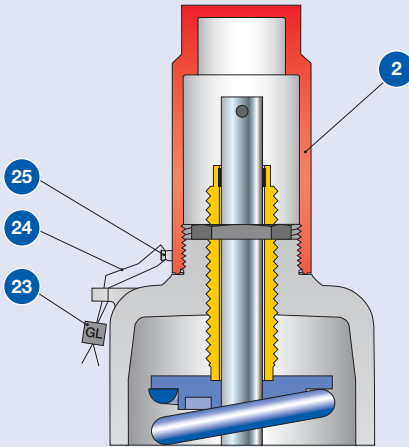

### Packed lever H4

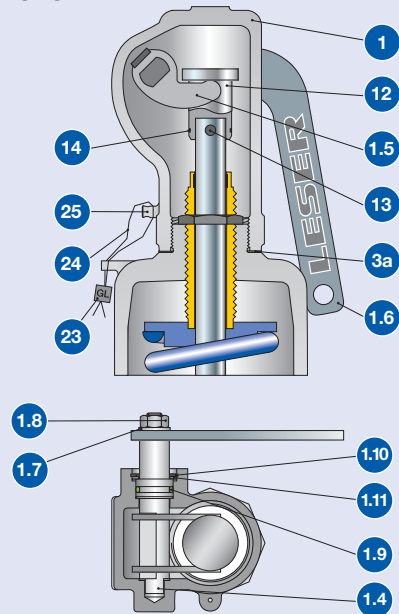

### Plain lever H3

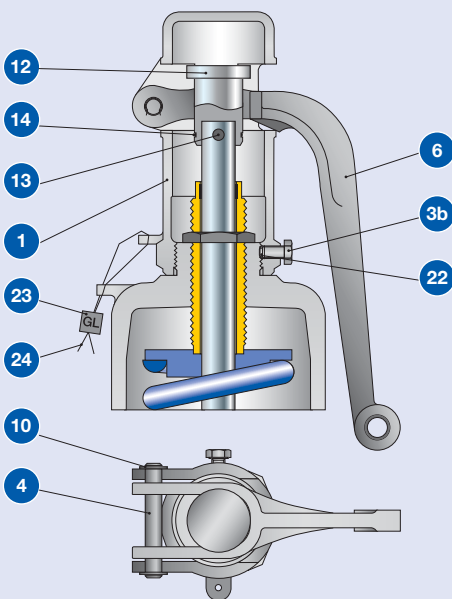

### Test gag

Cap H2: J70  
Packed lever H4: J69

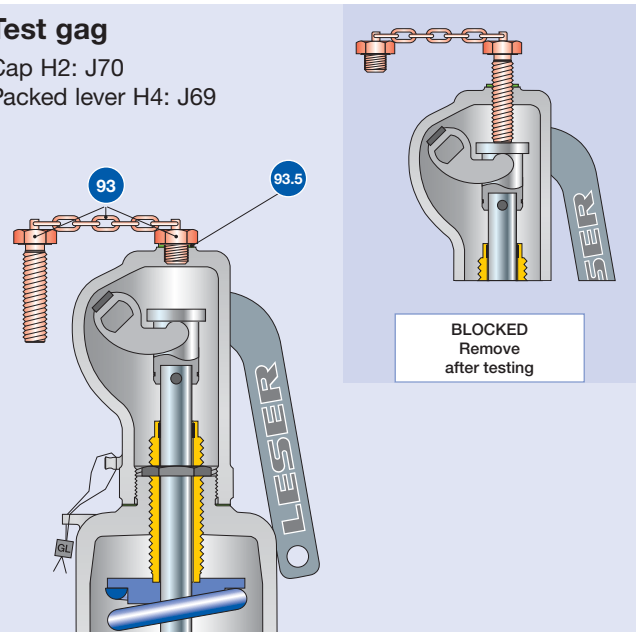

## Test gag

The test gag prevents the spindle from lifting and keeps the safety valve tight while the system pressure exceeds the set pressure.

### The test gag is used for:

- to perform pressure tests in a system without dismantling of the safety valve
- the individual adjustment of safety valves installed in the same system

After testing the test gag must be removed because otherwise the safety valve cannot protect the system against unallowable overpressure!

## Caps and levers – Subassembly item 40

Materials		Steel			Stainless steel	
Item	Component	Cap H2	Plain lever H3	Packed lever H4	Cap H2	Packed lever H4
1	Lever cover	–	0.7040	0.7040	–	1.4408
		–	Gr. 60-40-18	Gr. 60-40-18	–	CF8M
2	Cap	1.0718	–	–	1.4404	–
		Steel	–	–	316L	–
3a	Spacer	–	–	1.4571	–	1.4571
		–	–	316Ti	–	316Ti
3b	Hex screw	–	1.4401	–	–	–
		–	B8M	–	–	–
4 / 1.4	Shaft / bolt	–	1.4021	1.0718	–	1.4404
		–	420	Steel	–	316L
1.5	Lifting fork	–	–	1.0531	–	1.4571
		–	–	Steel	–	316Ti
6 / 1.6	Lever	–	0.7040	1.0036	–	1.4301
		–	Gr. 60-40-18	Steel	–	304
1.7	Washer	–	–	1.4401	–	1.4301
		–	–	316	–	304
1.8	Nut	–	–	A2 / Poly	–	1.4401
		–	–	2H	–	8M
1.9	O-ring	–	–	Viton®	–	–
		–	–	Viton®	–	–
1.9	Bushing	–	–	–	–	Graphite
		–	–	–	–	Graphite
10 / 1.10	Retaining clip	–	Carbon steel	Carbon steel	–	–
		–	Carbon steel	Carbon steel	–	–
1.10	Nut	–	–	–	–	1.4104
		–	–	–	–	Chrome steel
1.10	Packing gland	–	–	–	–	1.4404
		–	–	–	–	316L
1.11	Support ring	–	–	Carbon steel	–	–
		–	–	Carbon steel	–	–
12	Spindle cap	–	1.0718	1.0718	–	1.4404
		–	Carbon steel	Carbon steel	–	316L
13	Pin	–	Steel	Steel	–	1.4401
		–	Steel	Steel	–	8M
14	Retaining clip	–	1.4571	1.4571	–	1.4571
		–	316Ti	316Ti	–	316Ti
22	Plug	–	Plastic	–	–	–
		–	Plastic	–	–	–
23	Seal	Plastic	Plastic	Plastic	Plastic	Plastic
		Plastic	Plastic	Plastic	Plastic	Plastic
24	Seal wire	1.4541	1.4541	1.4541	1.4541	1.4541
		321	321	321	321	321
25	Sealing nose	1.4435	–	–	1.4435	1.4435
		316L	–	–	316L	316L
93	Test gag	1.4401	–	1.4401	1.4401	1.4401
		B8M	–	B8M	B8M	B8M
93.5	Washer	Fiber	–	Fiber	Fiber	Fiber
		Fiber	–	Fiber	Fiber	Fiber

**Please notice:**

- Modifications reserved by LESER.
- LESER can upgrade materials without notice.
- Every part can be replaced by other material acc. to customer specification.

## Caps and levers bolted – Subassembly item 40

**Bolted Cap H1**

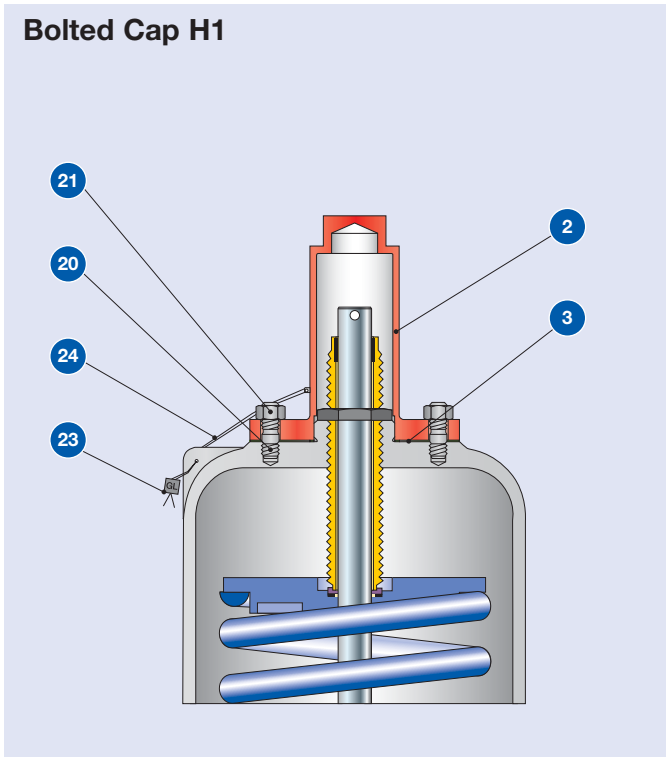

**Bolted lifting device H6**

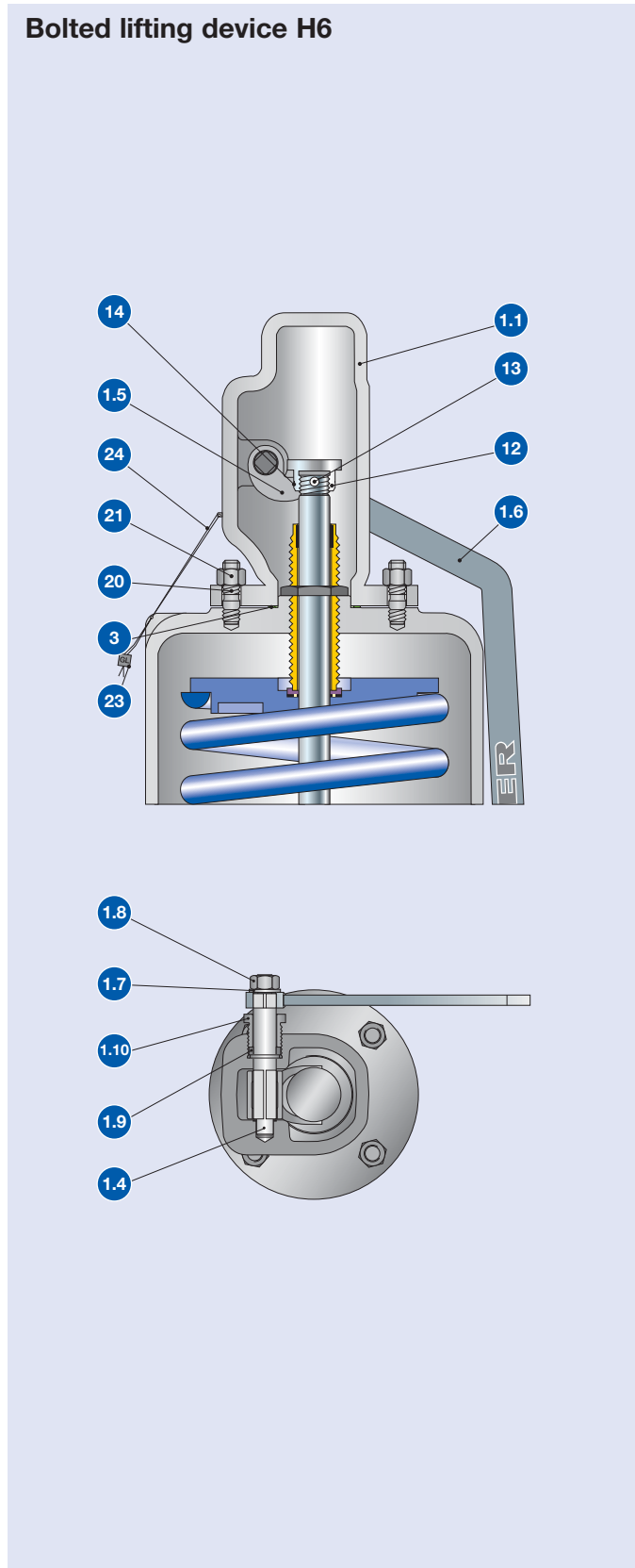

**Test gag**

Bolted cap H1: J70  
Bolted lifting device H6: J69

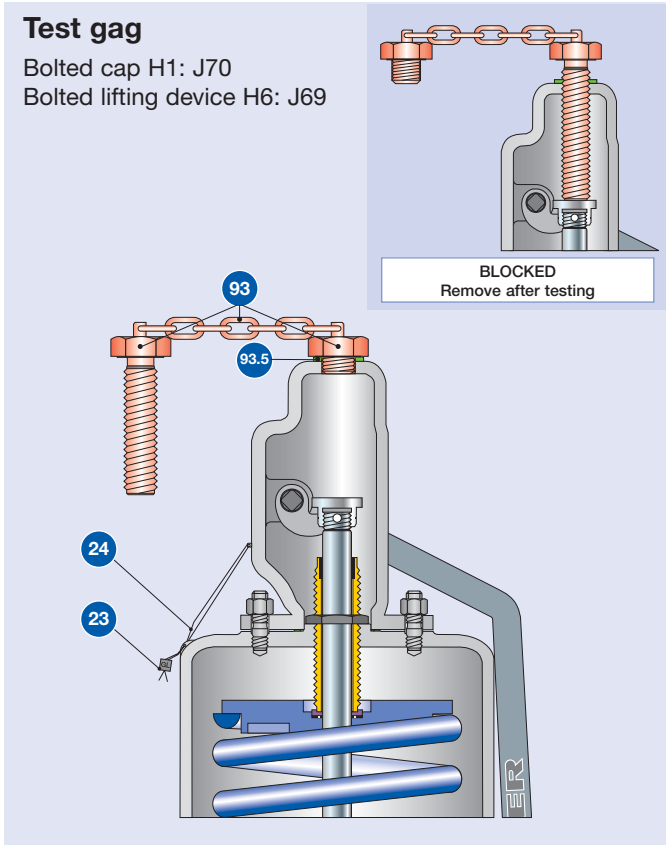
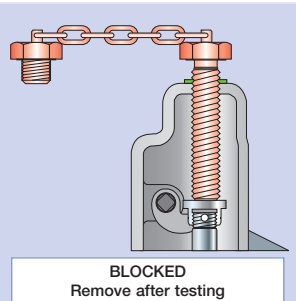

Description of the test gag please refer to page 99/02.

## Caps and levers bolted – Subassembly item 40

Materials		Steel		Stainless steel	
Item	Component	Bolted cap H1	Bolted lifting device H6	Bolted cap H1	Bolted lifting device H6
1.1	Lever cover	–	0.7040	–	1.4408
		–	Gr. 60-40-18	–	CF8M
1.4	Shaft/bolt	–	1.0718	–	1.4404
		–	Steel	–	316L
1.5	Lifting fork	–	1.4408	–	1.4408
		–	CF8M	–	CF8M
1.6	Lever	–	1.0036	–	1.4571
		–	Carbon steel	–	316Ti
1.7	Washer	–	Steel	–	1.4401
		–	Steel	–	316
1.8	Nut	–	1.0501	–	1.4401
		–	2H	–	8M
1.9	Bushing	–	Graphite	–	Graphite
		–	Graphite	–	Graphite
1.10	Packing gland	–	1.4104	–	1.4404
		–	Chrome steel	–	316L
2	Cap	0.7040	–	1.4408	–
		Gr. 60-40-18	–	CF8M	–
3	Gasket	Graphite / 1.4401	Graphite / 1.4401	1.4571	1.4571
		Graphite / 316L	Graphite / 316L	316Ti	316Ti
12	Spindle cap	–	1.0718	–	1.4404
		–	Carbon steel	–	316L
13	Pin	–	Steel	–	1.4401
		–	Steel	–	8M
14	Retaining clip	–	1.4571	–	1.4571
		–	316Ti	–	316Ti
20	Stud	1.1181	1.1181	1.4401	1.4401
		Steel	Steel	B8M	B8M
21	Nut	1.0501	1.0501	1.4401	1.4401
		2H	2H	8M	8M
23	Seal	Plastic	Plastic	Plastic	Plastic
		Plastic	Plastic	Plastic	Plastic
24	Seal wire	1.4541	1.4541	1.4541	1.4541
		321	321	321	321
93	Test gag	1.4401	1.4401	1.4401	1.4401
		B8M	B8M	B8M	B8M
93.5	Washer	Fiber	Fiber	Fiber	Fiber
		Fiber	Fiber	Fiber	Fiber

**Please notice:**

- Modifications reserved by LESER.
- LESER can upgrade materials without notice.
- Every part can be replaced by other material acc. to customer specification.

The bolted cap is standard for the steel version orifice 6 R 10 and 8 T 10

## Metal seat – Nozzle item 5 and disc subassembly item 7

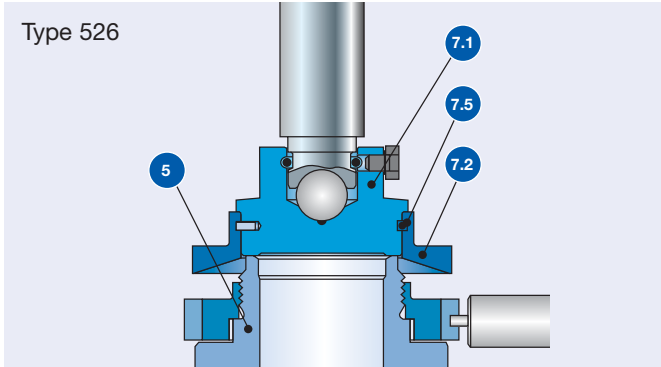

The LESER metal seats (disc and nozzle) are lapped to optical flatness to ensure a tight seal. LESER safety relief valves are supplied with standard leak tightness according to API 527. Improved tightness is available on request (option code J86).

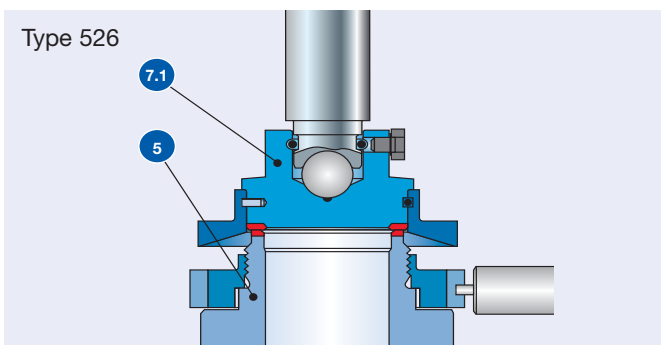

### Stellited sealing surfaces

The sealing surfaces of stainless steel disc and nozzle can be stellited by build-up welding. Stellite is a cobalt-chromium based, non-ferrous alloy with increased hardness, corrosion resistance and wear resistance up to high temperatures.

LESER recommends stellited sealing surfaces for Type 526 valves in the following cases:

- high pressure applications, due to the high stress of the sealing surfaces
- high temperature applications to avoid a permanent deformation of the sealing surfaces, due to the material properties of the seat and disc
- applications with abrasive fluids to increase the wear resistance of the sealing surfaces

Materials for disc and nozzle see page 99/07.

The stellited sealing surfaces of disc and nozzle are standard for high pressure and high temperature designs; see table materials page 99/07.

### Hardness metal seat

Material		Hardness of sealing surfaces		
EN	ASME	Values from standards or manufacturers specification		Average value LESER stock
EN 10088-3, 1.4122 hardened	Hardened stainless steel	≥ 40 HRC	LWN 325.01 Hardening procedure	42 – 46 HRC
EN 10272, 1.4404	SA 479 316L	≤ 215 HBW	EN 10272 Table 7	16 – 19 HRC <sup>1)</sup>
EN 10272, 1.4404 stellited	SA 479 316L stellited	≥ 35 HRC	Manufacturers specification	40 HRC
DIN EN 10213, 1.4408	SA 351 CF8M	≤ 22 HRC	LWN 290.05	14 – 16 HRC <sup>1)</sup>
DIN EN 10213, 1.4408 stellited	SA 351 CF8M stellited	≥ 35 HRC	Manufacturers specification	40 HRC

HBW: BRINELL hardness acc. DIN EN ISO 6506-1 / HRC: ROCKWELL hardness acc. DIN EN ISO 6508-1

<sup>1)</sup> Rockwell hardness values below 20 HRC are not allowed according to DIN EN ISO 6508-1. Lower, fictitious values were created for better comparison.

## Metal seat – Nozzle item 5 and disc subassembly item 7

Materials		Disc – Subassembly item 7			
		Steel		Stainless steel	
Item	Component	Standard	Stellited	Standard	Stellited
			Option code J25 + L44		Option code *
7.1	Disc	1.4122 hardened	1.4404 stellited	1.4404 stellited	1.4404 stellited
		Hardened stainless steel	316L stellited	316L stellited	316L stellited
7.2	Lifting aid	1.4404	1.4404	1.4404	1.4404
		316L	316L	316L	316L
7.5	Securing ring	1.4571	1.4571	1.4571	1.4571
		316Ti	316Ti	316Ti	316Ti

Material	Nozzle – Item 5						
	Flange rating class inlet						
	CL150 – CL300L		CL300		CL600		CL900 – CL2500
<b>Body material: 1.0619 WCB, LCB</b>							
Orifice	D – L	M – T	D – L <sup>1)</sup>	M – T	D – R	D – P	
Material	1.4408	1.4408 stel.	1.4408	1.4408 stel.	1.4408 stellited	1.4408 stellited	
	CF8M	CF8M stel.	CF8M	CF8M stel.	CF8M stellited	CF8M stellited	
<b>Body material: WC6</b>							
Orifice	D – T		D – T		D – R	D – P	
Material	–		1.4408 stellited		1.4408 stellited	1.4408 stellited	
	–		CF8M stellited		CF8M stellited	CF8M stellited	
<b>Body material: 1.4408 CF8M</b>							
Orifice	D – L	M – T	D – L <sup>2)</sup>	M – T	D – L <sup>3)</sup>	M – R	D – P
Material	1.4408	1.4408 stel.	1.4408	1.4408 stel.	1.4408	1.4408 stel.	1.4408 stellited
	CF8M	CF8M stel.	CF8M	CF8M stel.	CF8M	CF8M stel.	CF8M stellited

Options	Option code
Stellited, if not standard	<b>L62</b>
Nozzle material 1.4404/316L	<b>L64</b>
Nozzle material 1.4404/316L stellited	<b>L65</b>

<sup>1)</sup> Orifice L, CL300 is stellited

<sup>2)</sup> Orifice J, CL300 is stellited

<sup>3)</sup> Orifice H CL600, Orifice J CL600 and Orifice K CL600 are stellited

The standard facing for nozzles is serrated finish (SF). All nozzles with facings deviating from the standard such as RTJ-groove are made out of the material 1.4404/ 316L.

## Soft seal disc – Subassembly item 7

LESER soft seal solutions allow for superior tightness.

### Features and Benefits

- two different designs with o-ring or sealing plate for a wide variety application
- large selection of soft seal materials to best adapt to the application
- increased service life of sealing surfaces compared to a metal to metal seat
- simple replacement of the soft seal reduces maintenance costs
- standard ARP O-ring sizes for easy worldwide procurement
- one standard durometer per O-ring material for all set pressures to reduce stocking expenses

### Design of soft seal

Type 526	O-ring disc	Disc with sealing plate
<p>Design</p>		

For temperature limits, medium resistance and option codes please refer to the soft seal selection table, page 99/10 – 99/11. Materials for soft seal discs see page 99/09.

## Soft seal disc – Subassembly item 7

Materials		O-ring disc	
Item	Component	Steel	Stainless steel
1	Disc with lifting aid	1.4404 316L	1.4404 316L
3	Retainer	1.4404 316L	1.4404 316L
4	O-ring	See soft seal selection table, page 99/10	See soft seal selection table, page 99/10
5	Nut	1.4401 8M	1.4401 8M

Materials		Disc with sealing plate	
Item	Component	Steel	Stainless steel
1	Disc with lifting aid	1.4404 316L	1.4404 316L
3	Retainer	1.4404 316L	1.4404 316L
4	Sealing plate	See soft seal selection table, page 99/10	See soft seal selection table, page 99/10
5	Nut	1.4401 8M	1.4401 8M



## Soft seal selection

Soft seal selection								
Abbreviation ASTM 1418	Trade name (Designation)	Code- letter <sup>1)</sup>	Option Code	T <sub>min</sub>		T <sub>max</sub>		Application <sup>2)</sup>
				[°C]	[°F]	[°C]	[°F]	
<b>O-ring</b>								
CR	Neoprene®	K	J21	-40	-40	100	212	Paraffin oil, silicone oil and grease, water and waterbased solvents, refrigerants, ozone
NBR	Buna-N® (Nitrile-Butadiene)	N	J30	-25	-13	100	212	Hydraulic oil, vegetable and animal grease and oil
EPDM	Buna-EP® (Ethylene-Propylene-Diene)	D	J22	-45	-49	150	302	Hot water and superheated steam up to 150 °C, 302 °F, some organic and inorganic acids, silicone oil and grease, FDA compliant
FKM	Viton® (Fluorocarbon)	L	J23	20	-4	180	356	High temperature service (no superheated steam), mineral oil and grease, silicone oil and grease, vegetable and animal grease and oil, ozone, FDA compliant compound available on request
FFKM	Kalrez® (Perfluor)	C	J20	0	32	250	482	Nearly all chemicals, standard compound is Kalrez® 6375 with steam resistance, FDA compliant compound available on request
<b>Sealing plate (Special design, Option code S07)</b>								
SP	VESPEL SP-1® (Polyimide)	T	J49 + S07	-270	-454	300	572	High temperature and high pressure applications (no steam), for chemical resistance refer to manufacturers guide
PCTFE	KEL-F® (Polychlorotrifluoroethylene)	G	J48 + S07	-270	-454	204	400	Cryogenic and refrigeration applications, flammable media applications, (e.g. gaseous oxygen) up to 50 bar, 725 psig at 60 °C, 140 °F
PTFE	Teflon® (Polytetrafluoroethylene)	A	J44 + S07	-184	-300	150	302	Nearly all chemicals
Other than listed		X	For other materials please contact your local representative or sales@leser.com					

<sup>1)</sup> The code letters will be stamped on the disc (Item 1).

<sup>2)</sup> Pressure and temperature service must be considered in any case.

Chemical resistance information is supplied by the O-ring manufacturer. LESER can not take any warranty.

## Soft seal selection

Soft seal disc			Set pressure and size limits				
Material			Pressure range		Pressure range		Orifice
			min.		max.		
			[bar]	[psig]	[bar]	[psig]	
<b>O-ring</b>							
NBR	"N"	J30	0.3	4	102	1480	D – K
CR	"K"	J21			75.8	1100	L – M
EPDM	"D"	J22			68.9	1000	N – P
FKM	"L"	J23			41.3	600	Q
FFKM	"C"	J20			20.6	300	R – T
<b>Sealing plate (Special design, Option code S07)</b>							
SP	"L"	J49	10	150	400	5800	D – G
PCTFE	"G"	J48	1	15	300	4350	D – T
PTFE	"A"	J44	1	15	10	145	D – T

## Balanced bellows – Subassembly item 15

LESER is able to provide a balanced bellows design through the use of Balanced bellows.

Balanced bellows are generally used for two applications:

- to compensate for back pressure
- to seal off the bonnet from the outlet chamber

### Compensation for back pressure

The back pressure acts on the reverse side of the disc, creating a force in the closing direction ( $F_C$ ) of the safety valve. The magnitude of this force depends on the seat area and the level of the back pressure. The balanced bellows constitute an opposite area with the same area like the seat. The back pressure acts on, thereby reducing or eliminating the closing force. This reduction of the force in the closing direction can be viewed as a compensating force acting in the opening direction ( $F_O$ ).

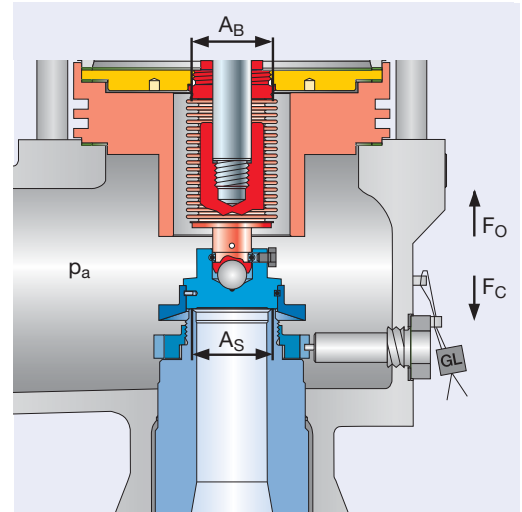

A quantitative representation is shown in the table below:

Actual area	Back pressure	Actual force	Direction of force	Compensation criteria
Seat area = $A_S$	$p_a$	$F_C = p_a \times A_S$	closing	$A_S = A_B$
Bellows area = $A_B$	$p_a$	$F_O = p_a \times A_B$	opening	$F_C = F_O$

### Sealing the bonnet from the outlet chamber

LESER's balanced bellows reliably seal the bonnet from the outlet chamber; protecting the guide, moving parts and the spring from problems associated with the fluid, such as dirt, corrosion, impurities of temperature.

#### Balanced bellows

Type 526	Orifice D – 6 R 8	6 R 10 – 8 T 10
Design		
Bonnet spacer	*	–
Bellows housing	*	*
The bellows housing protects the bellows against turbulences during discharge to avoid bellows vibration and to guarantee a longer life-time.		
Control thread	ASME B1.20.1 NPT 1/2	*
A control thread ASME B1.20.1 NPT 1/2 is fitted into the bonnet to monitor the condition of the bellows. A discharge pipe can be fitted to the NPT 1/2 control thread to allow safe discharge of aggressive or toxic fluids.		
Option code		
Standard bellows	J83	J83
Other materials than stand.	S15 + material designation	S15 + material designation

The dimensions and weights of a safety valve with balanced bellows are displayed in the tables "Dimensions and weights".  
The temperature range is displayed in the tables "Pressure temperature ratings".

## Balanced bellows – Subassembly item 15

Material			
Item	Component	Material	
11	Bonnet spacer	Type 5262: 1.0460	1.4404
		Carbon steel	316L
15.1	Upper end piece	1.4404	
		316L	
15.2	Lower end piece	1.4404	
		316L	
15.3	Balanced bellows	2.4856	
		INCONEL 625	

### Standard bellows in INCONEL 625

Due to the thin-walled, bellows are the most sensitive components of the safety valve in relation to corrosion and temperature load.

To increase the life cycle of the bellows, in corrosive and high temperature applications as well, LESER offers from October 2010 INCONEL 625 as standard material for the balanced bellows in the API Series 526. The higher grade INCONEL 625 replaces the stainless steel material 316Ti / 1.4571.

#### Bellows material INCONEL 625

INCONEL 625 is a nickel base material and compared to 316 stainless steel it provides significantly better

- corrosion resistance especially in applications where chlorides are present
- high temperature resistance

LESER uses only INCONEL 625 LCF® or INCONEL 625 with equivalent properties to INCONEL 625 LCF®. The minimum criterion for every bellows is 10.000 load cycles which is a very high value compared to the operating conditions of most safety valves.

® = INCONEL and 625 LCF are trademarks of the Special Metals Corporation group of companies.

#### End connections

LESER's bellows design is such that at both ends the bellows has welded end pieces which connect the bellows to the disc and the guide. The two end pieces of the standard bellows remain in stainless steel 316L.

#### Interchangeability

The old stainless steel bellows and the new INCONEL 625 bellows are one to one interchangeable without the need to change other components of the valve.

#### Ordering

With the introduction of the INCONEL 625 bellows LESER will also make the ordering for Type 526 easier. It will no longer be necessary to distinguish between closed bonnet and open bonnet. Option code J83 will be sufficient to order a balanced bellows for both.

## Bug screen

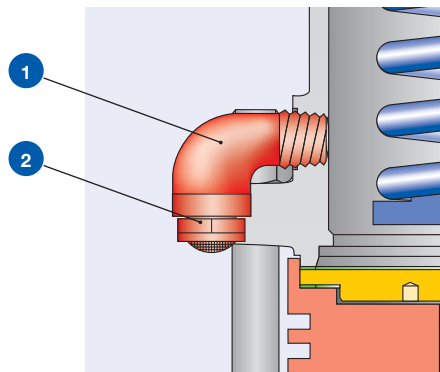

The bug screen is screwed in at safety valves with bellows at the bonnet vent in order to prevent the intrusion or rather nesting of beetles, termites, ants etc. at the bonnet space.

Such nest-building especially at the spindle guide can lead to disfunction of the safety valve. This danger occurs only at plants for gases and liquids and in environments supporting high insect populations.

The function of bellows or rather safety valves will not be hindered by the bug screen.

The option code for ordering is M70.

Material			
Item	Component	Steel design	Stainless steel
1	90° bow NPT 1/2"	Steel	Stainless steel
2	Screen NPT 1/2"	Stainless steel	Stainless steel

## Balanced bellows conversion kits

LESER balanced bellows conversion kits are available to convert from a convential design into a balanced bellows design with little effort. The conversion kits contain all the necessary parts for conversion as well as instructions. For article no. and spare parts please refer to spare part page 01/83.

Conversion kits			
Item	Component	Quantity	Material
8	Guide	1	1.4404 316L
11	Bonnet spacer / Cooling spool	1	1.4404 316L
12	Spindle	1	1.4404 316L
15	Bellows	1	2.4856 / 1.4404 INCONEL 625 / 316L
55	Stud	4, 8, 12 depends on valve size	1.4401 B8M
60	Gasket	2, 3 depends on valve size	Graphite / 1.4401 Graphite / 316
-	Installation instruction LWN 037.05	1	

## High temperature equipment

For fluid temperatures higher than 400 °C/752 °F high temperature equipment is necessary to protect the inner parts and the spring against inadmissible influence of temperature. The maximum inlet temperature is 538 °C/1000 °F. The equipment

shown is only fitted in Type 5267. For all other Types an open bonnet and a balanced bellows is necessary for fluid temperatures exceeding 400 °C/752 °F up to max. 450 °C/842 °F.

### Specification

Type 5267

Design

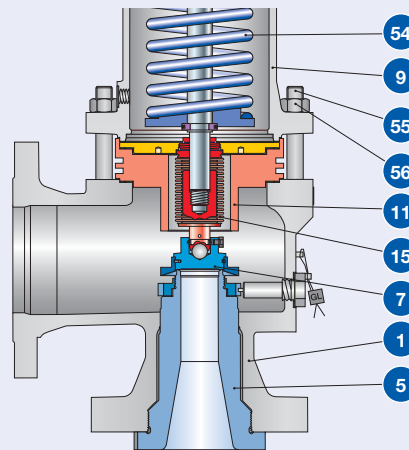

Option code

J88

#### Operating conditions

Temperature limits	[°C]	> 400 fluid temperature
	[°F]	> 752 fluid temperature
	max. [°C]	538 inlet temperature
	max. [°F]	1000 inlet temperature

### Materials

#### High temperature equipment

Item	Component	
1	Body	1.7357
		WC6
5	Nozzle	1.4408
		CF8M
7	Disc	1.4404 stellite
		316L stellite
9	Bonnet open	1.0619
		WCB
11	Cooling spool	1.4404
		316L
15	Bellows	2.4856 / 1.4404
		Inconel 625 / 316L
54	Spring	1.7102, 1.8159
		High temperature alloy steel
55	Studs	1.7709
		B16
56	Nuts	1.7258
		7M

## Inconel X-750 Spring

LESER offers the spring material INCONEL X-750 / 2.4669 as an Option of Type 526 for all valve sizes and the complete pressure range.

### Applications

INCONEL X-750 is recommended in the following applications:

- **Sour gas applications acc. to NACE MR 0175 and NACE MR 0103:**  
if NACE conditions are present at the outlet of the safety valve (NACE Level 2). INCONEL X-750 is a spring material which is recommended in the NACE standards.
- **High temperature applications:**  
INCONEL X-750 allows higher operating temperatures than other standard spring materials. With a spring in INCONEL X-750 it is possible to use a conventional safety valve with closed bonnet for medium temperatures of 538 °C/1000 °F without the need of a bellows for spring heat protection.
- **Highly corrosive applications:**  
applications that require a spring material with a corrosion resistance superior to that of stainless steel, e.g. seawater applications.

### Option Code

Option code X08: Spring material INCONEL X-750

### Ordering

The option code for ordering is X08. Spring part numbers and pressure limits can be taken from the actual spring charts LWN 060.30 and 062.30.



## O-ring damper

The O-ring damper can be employed to suppress or reduce oscillations of moving parts in a safety valve.

LESER has ensured proper performance of the O-ring damper through extensive tests at its certified test labs.

For applications according to CE/VdTUEV O-ring damper are available on request. If an O-ring damper is required further testing must be performed, which will require a longer lead time; please contact sales@leser.com.

Safety valves with O-ring damper are not designated in the ASME code.



Cap H2



Packed lever H4

## Lift indicator

The lift indicator is a useful device that can be used in process control to monitor the operating status of a safety valve. To detect lifting, LESER provides a special lifting device H4 incorporating a proximity switch (see drawing right).

The lift indicator will detect a safety valve lift equal to or more than 1 mm / 0.04 in, which may be the result of overpressure or of operation of the lifting device.

LESER provides inductive DC proximity switches, type DIN EN 60947-5-6 (NAMUR) using two-wire technology. These intrinsically safe proximity switches can be used in explosion hazard area zone 0 (Ex II 1 D Ex iaD 20 T6). Other types of proximity switch may be used. If a technical specification is supplied along with the type of connection thread LESER can verify compatibility.

For technical details of proximity switch refer to manufacturers homepage: [www.pepperl-fuchs.com](http://www.pepperl-fuchs.com).

For assembly and adjustment refer to LESER works standard LWN 323.02-E.

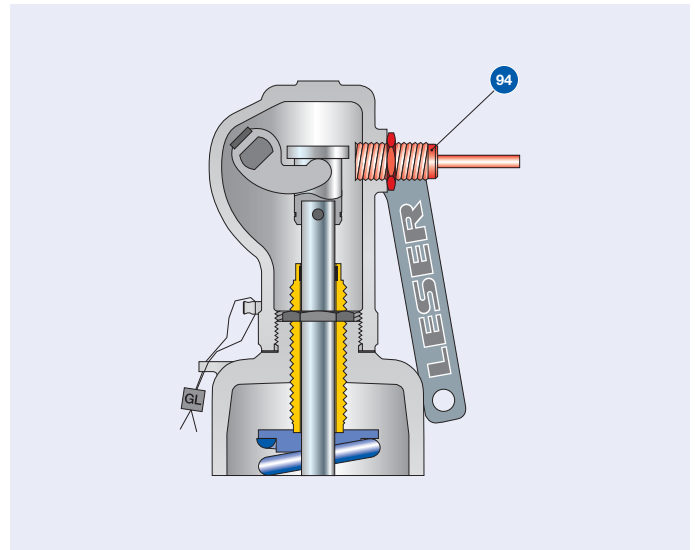

Packed lever H4 or bolted cap H6

### Availability

Item	Component	Option code
9	Bonnet with adaptor for lift indicator	J38
40	Lifting device H4 with adaptor for proximity switch M18 x 1 [mm]	J39
94	Lift indicator M18 x 1, used type = PEPPERL+FUCHS NJ5-18GK-N	J93

### Operating chart

#### A, closed position

The lift indicator is positioned in front of the coupling or control sleeve when the safety valve is closed.

#### B, open position

When the safety valve opens or is lifted (in both cases at least 1 mm / 0.04 inch), the lift indicator changes its signal. The signal also changes if the lift indicator accidentally becomes loosened or unscrewed (fail safe).

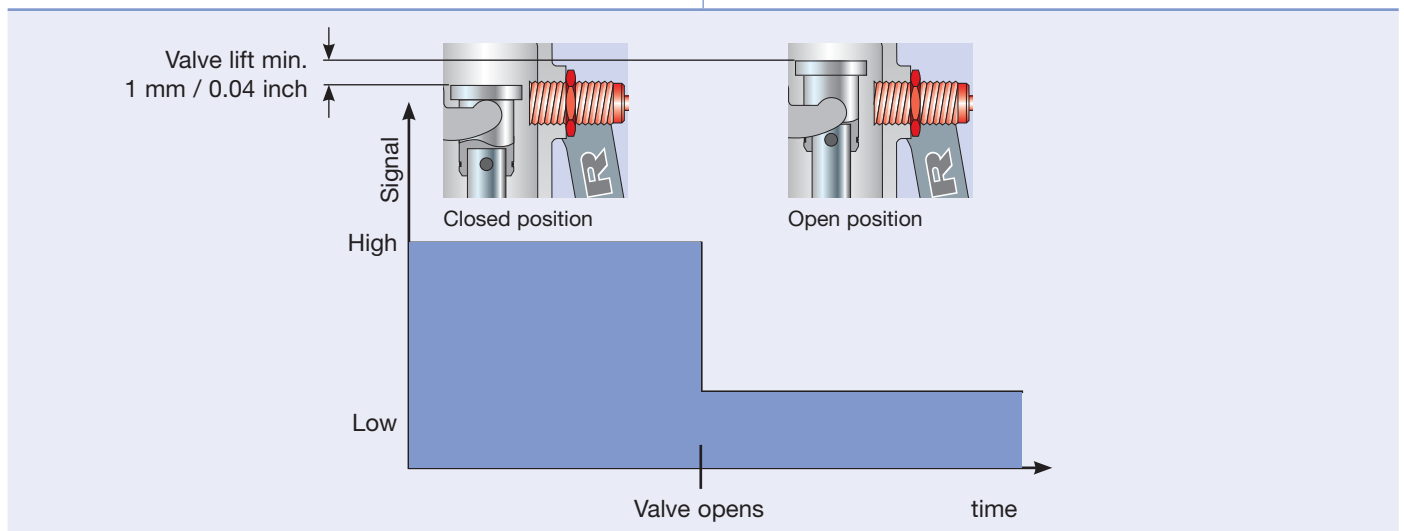



## Heating jacket

### Application and design

Safety valves in systems which need to be protected from media that are viscous, sticky, or have the tendency to crystallize out of solution can be fitted with a heating jacket.

The heating jacket is constructed with a welded design and covers the body, allowing heating medias (steam, heat transfer oil, etc.) to pass through the space created.

To protect the spindle and the moving parts against sticking LESER recommends the use of a heating jacket in combination with the balanced bellows design.

For safety valves with balanced bellows, the bonnet spacer required to house the bellows is fitted with an additional heating jacket. Both heating jackets are joined by a tubing.

If there is no risk of solidification of the media at the outlet a safety valve without balanced bellows can be used as well.

The position of the heating connections is shown in figure 1 to 3.

### Specifications of the Heating Jacket

The operating data for the heating jacket are shown on a separate name plate.

### Slip on flanges

Flanged heating connections are supplied as slip on flanges for better alignment of the flange connection.

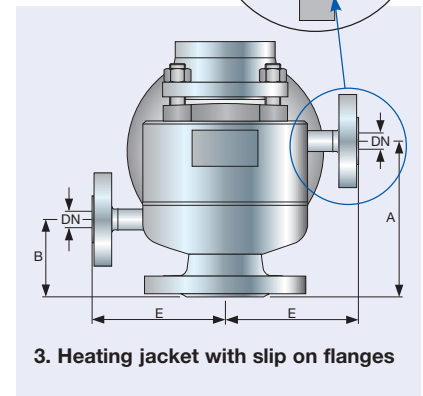
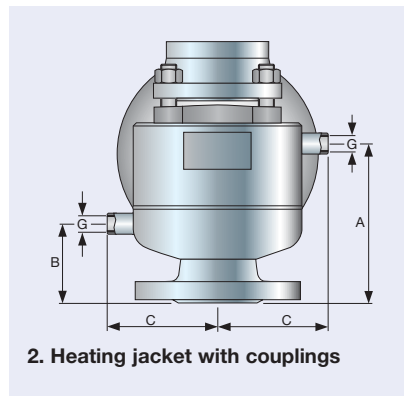
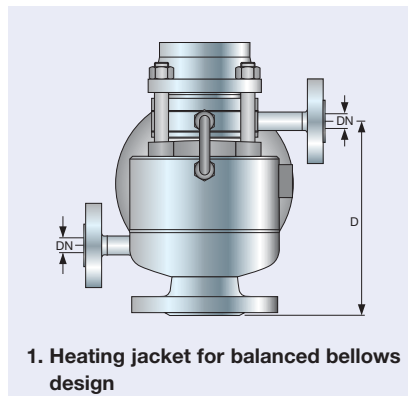
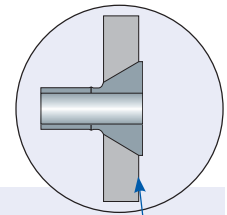

Heating jacket									
<b>Valve size</b>		1 D 2	1 1/2 F 2	2 H 3	3 J 4	4 N 6	6 Q 8	8 T 10	
		1 E 2	1 1/2 G 3	2 J 3	3 K 4	4 P 6	6 R 8		
					3 K 6				
					3 L 4				
<b>Materials</b>									
<b>Body</b>	<b>Series 526</b>	CF8M 1.4408	CF8M 1.4408	CF8M 1.4408	WCB 1.0619, CF8M 1.4408	WCB 1.0619, CF8M 1.4408	WCB 1.0619, CF8M 1.4408	WCB 1.0619, CF8M 1.4408	
<b>Heating jacket</b>					1.4541				
					321				
<b>Connections</b>		<b>Option Code</b>							
<b>Slip on flange</b> DIN	<b>DN 15, PN 25</b>	1.4571, 1.4404 316Ti, 316L	H31	H31	H31	-	-	-	-
	<b>DN 25, PN 25</b>	1.4571, 1.4404 316Ti, 316L	-	-	-	H32	H32	H32	H32
<b>Slip on flange</b> ANSI B16.5	<b>1/2", class 150</b>	1.4404 316L	K31	K31	K31	-	-	-	-
	<b>1", class 150</b>	1.4404 316L	-	-	-	K32	K32	K32	K32
<b>Couplings</b> DIN 2986	<b>G 3/8</b>	1.4571 316Ti	H29	H29	H29	-	-	-	-
	<b>G 3/4</b>	1.4571 316Ti	-	-	-	H30	H30	H30	H30
<b>Bonnet spacer</b>		1.4404 316L	H33	H33 <sup>1)</sup>	H33	H33	H33	H33	-

<sup>1)</sup> Option code H33 is not possible for 5262.029x and 5262.030x.

## Heating jacket

Metric Units									
Valve size		1 D 2	1 1/2 F 2	2 H 3	3 J 4	4 N 6	6 Q 8	8 T 10	
		1 E 2	1 1/2 G 3	2 J 3	3 K 4	4 P 6	6 R 8		
					3 K 6				
					3 L 4				
Series 526				Dimensions					
[mm]	A	105	117	130	160	210	285	404	
	B	75	80	80	100	120	156	65	
	C	96	110	96	162	187	240	–	
	D	–	181	204	–	–	389	–	
	E	122	136	136	200	225	267	305	
	Slip on flange DN	15	15	15	25	25	25	25	
[inch]	Couplings G	3/8	3/8	3/8	3/4	3/4	3/4	3/4	
Operating conditions				Operating pressure [bar]					
Operating temperature		20 °C	25	25	25	15	15	12	12
		300 °C	18	18	18	11	11	9	9

US Units									
Valve size		1 D 2	1 1/2 F 2	2 H 3	3 J 4	4 N 6	6 Q 8	8 T 10	
		1 E 2	1 1/2 G 3	2 J 3	3 K 4	4 P 6	6 R 8		
					3 K 6				
					3 L 4				
Series 526				Dimensions					
[inch]	A	4 1/8	4 5/8	5 1/8	6 5/16	8 1/4	11 1/4	15 7/8	
	B	3	3 1/8	80	4	4 3/4	6 1/8	2 1/2	
	C	3 3/4	4 3/8	3 3/4	6 3/8	7 3/8	9 1/2	–	
	D	–	7 1/8	8	–	–	15 3/8	–	
	E	4 3/4	5 3/8	5 3/8	7 7/8	8 7/8	10 1/2	12	
	Slip on flange DN	1/2	1/2	1/2	1	1	1	1	
[inch]	Couplings G	3/8	3/8	3/8	3/4	3/4	3/4	3/4	
Operating conditions				Operating pressure [psig]					
Operating temperature		68 °F	363	363	363	218	218	174	174
		572 °F	261	261	261	160	160	131	131

# LESER worldwide

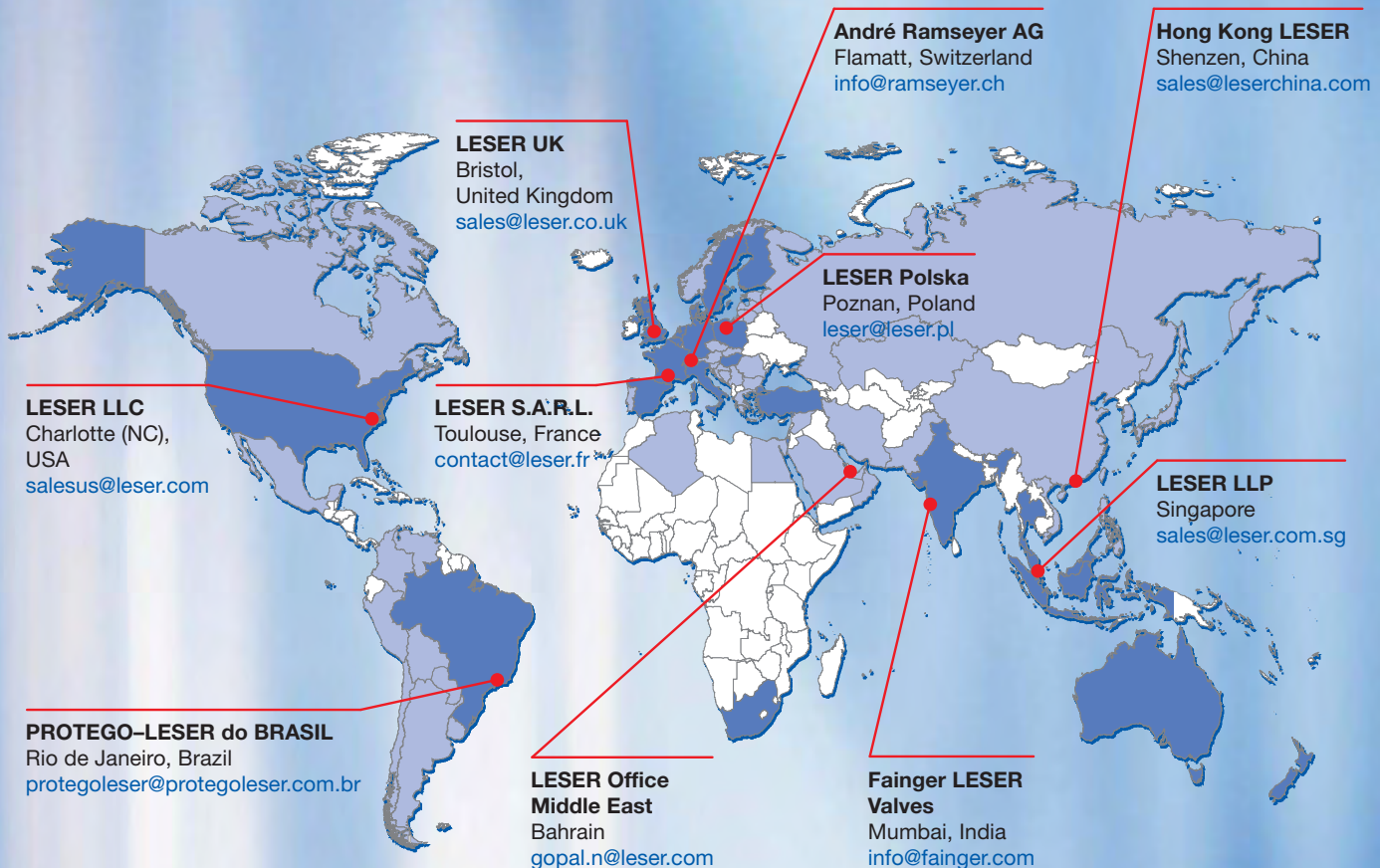

API Catalog  
Edition September 2010 / 4000  
LWN 480.01-E / 0777.5489

# LESER

The-Safety-Valve.com

LESER GmbH & Co. KG

20537 Hamburg, Wendenstr. 133-135  
20506 Hamburg, P.O. Box 26 16 51

E-Mail: sales@leser.com  
www.leser.com